



light design & technology

TRONIX guided by light





Light connects. It creates atmosphere, experiences and emotion. As a comprehensive LED supplier, we have the perfect answer for any light-related question. For you, for ourselves, and out of respect for the beauty around us. We're guided by light.



Care

We care for our clients. We help them do what they do best. We strive to build a long-term relationship, so that we can rely on one another unconditionally.

We zorgen voor onze klanten. We helpen ze te doen waar ze goed in zijn. We streven naar een duurzame relatie, zodat we onvoorwaardelijk op elkaar kunnen bouwen.



Share

Knowledge is power, but sharing is even more powerful. Because sharing means: growing together. We as a supplier, and our client as an authority/specialist for their own clients.

Kennis is kracht, kennis delen is nog veel krachtiger. Want delen betekent: samen groeien. Wij als leverancier, en onze klant als autoriteit/specialist voor zijn eindklant.



Connect

We connect people and partners. Together, we can make one plus one equal three. We see the market as a dynamic playing field, where together we can make 'beautiful' even more beautiful!

We verbinden mensen en partijen. Samen maken we van één plus één drie. We zien de markt als een dynamisch speelveld, waarin we samen 'mooi' nog mooier maken.

TRONIX guided by light

Light design & technology

🇬🇧 Our high-end selection of decorative led applications and control options is our seal mark of 25 years experience in the light technology sector. We're real 'LED nerds', with a know-how factor that you can rely on 100%. We bring lighting solutions that excel in function and wow factor.

Custom solutions? No problem. You can also rely on us for any adjustments to existing light solutions. Our mission is to have design and technique dance a perfect tango for you, with quality and satisfied customers as our top priority. We're proud of our trade and use all of our knowledge and expertise to do what we promise. We always think in terms of solutions. And always manage to find them!



🇳🇱 Ons high-end aanbod in decoratieve led toepassingen en aansturingsmogelijkheden is het keurmerk van 25 jaar expertise in lichttechniek: we zijn echte 'led-nerds' met een knowhow-factor waar je voor de volle 100 procent op kunt bouwen. We gaan voor slimme lichtoplossingen die uitblinken in functie én wow-factor.

Maatwerk? Regelen we voor je. Voor aanpassingen op bestaande lichtoplossingen kun je op onze lichtexperts rekenen. We laten design en techniek perfect voor jou samenwerken. Kwaliteit en tevreden klanten staan bij ons op nummer één. We zijn trots op ons vak, en we zetten al onze kennis en kunde in om te doen wat we beloven. Daarbij denken we altijd in oplossingen. En die vinden we!





Office and showroom in Uden - The Netherlands



Looking for our latest product releases? We keep continued focus on new product development and further extension of our range. Visit our website for a most actual overview.

Op zoek naar onze allernieuwste producten? We werken voortdurend aan nieuwe productontwikkeling en een verdere uitbreiding van ons assortiment. Bezoek onze website voor het meest actuele overzicht!



Order online? Ask for your personal login account at sales@tronixlighting.com

Orders placed before 12.00h (GMT +1) will be shipped the same day



Check our complete
catalog range online

Bekijk alle Tronix product
catalogi online



lighting guide 2022-2023

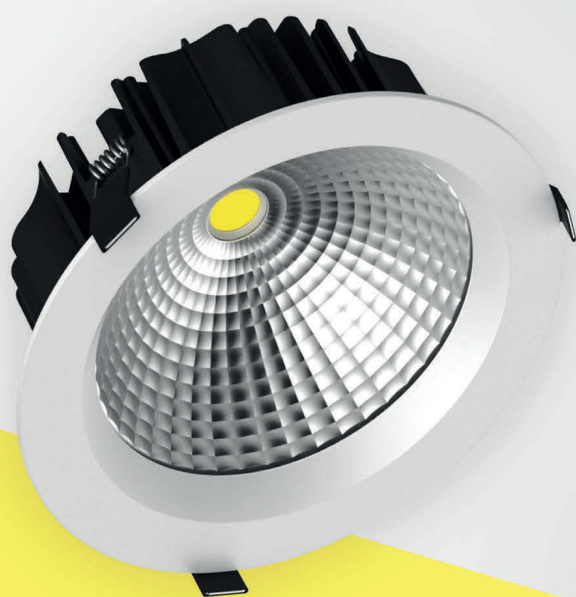

 **TRONIX** guided by light

lighting guide

TRONIX guided by light



TRONIX guided by light



Content

1. Drivers & Controllers



10

2. LED Strips



52

3. Modules



66

4. Advertising & Signing



74

5. Wall Washers



82

Photography / Fotografie:



Fenna Gijswijt fotografie /



Hans Koster /



Ronald Strijbosch / Margot van den Nieuwenhuizen

Adobe Stock Foto's

The images and information provided in this catalogue are composed with great care, but may be always subject to alterations. Tronix Lighting accepts no liability for misprints, errors or unforeseen changes.

De beelden en informatie zoals deze zijn weergegeven in deze catalogus zijn met zorg samengesteld maar blijven altijd onder voorbehoud. Tronix Lighting accepteert geen aansprakelijkheid voor drukfouten en onvoorziene wijzigingen.

Technical indications

There is a lot to know about light and we think it is important to share this knowledge with you. Why? Because we place high demands on the quality of our lighting products, and this information will help you to qualify and compare products better. Below overview of important technical specifications and measurement factors can be of help.

CRI value

The Color Rendering or Color Rendering Index (CRI value) tells you on a scale of 0-100% how 'true' a light source represents the colors compared to real daylight. The higher the CRI value of a light source, the more real the colors. A CRI value value of 80 means a quite high color rendering; CRI value values of 90 or more have an excellent color rendering.

Dimming

LED can be dimmed in many ways. A primary condition is that the LED lamp itself is suitable for dimming, and also the dimmer must be fit for controlling the LED. On top of that, the driver needs to be suitable for the combination of dimmer and LED lamp. And there is a difference of control between LED dimmers: it can be analogue (0-10 V, 1-10V, trailing edge dimming) or digital (DALI, Casambi dimming).

EIA

Led lighting is eligible for energy investment deduction (EIA) in a number of countries. This concerns subsidy money that allows you to deduct 45% of the investment (luminaires + assembly) from the profit tax. To qualify for this subsidy, LED lighting fixtures meets the lifespan criteria L90B50 at 50.000 hours and must be measured in accordance with LM-80.

Flicker-free

The flickering of a light source is expressed in a Flicker percentage, and caused by the quality of the used Led driver. The lower the percentage, the better. A Flicker value > 35% is experienced as very annoying; values up to 15% can cause fatigue or headaches. All Tronix lighting and LED drivers have a flicker percentage below <1% and therefore meet all current EPREL requirements.

IP rate

Ingress Protection (International Protection Rating) of a product, normalized to the IEC60529 standard. The IP value is expressed in 2 digits; the first number indicates the protection value against dust/touch, the second number the protection value against moisture. In case of Led lighting, IP ratings vary from IP20, non- or poorly resistant to dust and moisture, up to IP68 - water resistant and 100% dust resistant.

IK rate

The Impact Protection Rating says something about the impact resistance of a luminaire, so to what extent it is resistant to mechanical shocks. In practice, this value varies from IK02 to IK10. The higher the IK value, the higher the impact resistance. Tronix wall/ceiling luminaires vary in value from IK08 (resistant to 5 Joule shocks) to IK10 (vandal-proof with a 20 Joule shock resistance).

Kelvin

The Kelvin (K) value indicates the color temperature. The lower the Kelvin value, the warmer the light looks. The higher the number of Kelvin, the 'colder' the light. The standard Kelvin values for Led lighting start at 2300K (warm white) to 7000K (cold white).

Lifespan

The lifespan of Led is many times longer than that of conventional lighting, such as incandescent lamps. A good Led easily achieves a lifespan of 50,000 hours, however the actual lifetime of the Led strongly depends on the ambient temperature (in connection with cooling), and the electronics used. The more stable the strength of current, the longer the lifespan. The humidity level of the Led environment is also an influential factor. In the course of time, it is however inevitable that the Luminous flux will eventually decrease to a maximum of 70%.

Luminous flux

The amount of light (current) that a light source produces, in other words the sum of all emitted light, regardless of the direction in which the light shines. The Luminous flux value is often expressed as Luminous flux per Watt, which expresses the efficiency of the LED. With a Luminous flux of >130 Lm / Watt, Tronix High Efficiency Panels score very high on an operating efficiency level, making them eligible for EIA.

LUX

The amount of lux is the most reliable measurement value for lighting and says something about the amount of light (Luminous flux) that ends up on a certain surface. 1 lux = 1 Lm / m². For example: a light source of 1000 Lm spread over 1 m² illuminates that square meter with 1000 Lux. Spread that same 1000 Lm over 10m², and it will then only illuminate 100 Lux. European standards for lux values in various interior lighting environments are captured in NEN 1246-1 regulations.

Power factor

The power factor represents the relationship between the actual power (P) and the apparent power (Ps). The lower the power factor, the higher the unwanted power consumption. High quality Led lighting has a power factor of at least 0.90 and is now running up to 0.95 (max. 5% undesired power consumption). Inferior LED products have a considerably lower power factor; In addition to higher electricity costs, this also results in dangerous situations due to the large amount of reactive current.

UGR

The Unified Glare Rating indicates the degree of light nuisance or glare. The average value is between 15 and 30. Below 10 there is no glare.

Communication protocol

With a large variation in control and dimming techniques, the possibilities with the current Tronix range are endless. For example; we have DALI, Casambi, ZigBee, DMX, Triac and 1-10V. Can't find the right protocol? Each fixture can be supplied with integrated control in any desired protocol, simply ask us about the options and possibilities.

Technische aanduidingen

Er is veel te weten over licht en wij vinden het belangrijk om deze kennis met u te delen. Waarom? Omdat we hoge eisen stellen aan de kwaliteit van onze verlichting, en deze informatie u zal helpen om producten beter te beoordelen en met elkaar te vergelijken. Onderstaand overzicht van belangrijke technische specificaties en meefactoren zijn hierbij een helpende hand.



CRI value

De kleurweergave of Color Rendering Index (CRI value) geeft op een schaal van 0-100% aan hoe 'kleurecht' een lichtbron de kleuren weergeeft in vergelijking tot daglicht. Hoe hoger de CRI value van een lichtbron, hoe echter de kleuren. Een CRI value waarde van 80 betekent een hoge kleurweergave; CRI value waarden van 90 of meer hebben een uitstekende kleurweergave.



Dimming

Led is op vele manieren te dimmen. Voorwaarde is wel dat de led lamp zelf geschikt is om te dimmen en de dimmer moet ook geschikt zijn voor het aansturen van de Led. Bij aanwezigheid van een driver moet deze daarnaast ook geschikt zijn voor de combinatie dimmer en led lamp. Tussen led dimmers zit ook nog een verschil van aansturing, deze kan Analoog (0-10 V, 1-10V, Fase Aan-/afsnijding Dimming) of Digitaal zijn (DALI, Casambi).



EIA

Led verlichting komt in een aantal landen in aanmerking voor energie investeringsaftrek, een subsidiepotje waarbij men 45% van de investering (armaturen + montage) mag aftrekken van de winstbelasting. Om voor deze subsidie in aanmerking te komen moet het armatuur aan de levensduurcriteria L90B50 bij 50.000 uur en dienen gemeten te zijn conform LM-80.



Flikkervrij

Het knipperen van een lichtbron wordt uitgedrukt in een Flikkerpercentage, en veroorzaakt door de kwaliteit van de gebruikte Led driver. Hoe lager het percentage, hoe beter. Een Flikkerwaarde >35% wordt als zeer hinderlijk ervaren; waarden tot 15% kunnen vermoeidheids- of hoofdpijnklachten veroorzaken. Alle Tronix verlichting en led drivers hebben een Flikkerpercentage onder de <1% en voldoen daarmee aan alle huidige EPREL eisen.



IP rate

Ingress Protection (International Protection Rating) van een product, genormaliseerd volgens de IEC60529 norm. De IP waarde wordt in 2 cijfers uitgedrukt; het eerste getal geeft de beschermwaarde aan tegen stof/aanraken, het tweede getal de beschermwaarde tegen vocht. In de Led verlichting variëren de IP ratings van IP20 – niet (goed)bestendig tegen stof en vocht – tot aan IP68 – waterbestendig en 100% stofbestendig.



IK rate

De Impact Protection Rating zegt iets over de slagvastheid van een armatuur, dus in hoeverre deze bestand is tegen mechanische schokken. In de praktijk varieert deze waarde van IK02 tot IK10. Hoe hoger de IK waarde, hoe hoger de slagvastheid. De wand-/plafondarmaturen van Tronix variëren in waarde van IK08 (weerstand tegen schokken van 5 Joule) tot IK10 (vandalismebestendig met een weerstand tegen schokken van 20 Joule).



Kelvin

De Kelvin (K) waarde duidt op de kleurtemperatuur. Hoe lager de K waarde, hoe warmer het licht oogt. Hoe hoger het aantal Kelvin, hoe 'kouder' het licht. De standaard Kelvin-waarden beginnen bij 2300K (warm wit) tot 7000K (koud wit).



levensduur

De levensduur van led-verlichting is vele malen langer dan dat van conventionele verlichting zoals gloei- en halogeenlampen. Een goede led haalt makkelijk een levensduur van 50.000 uur, echter de uiteindelijke levensduur van de led is sterk afhankelijk van de omgevingstemperatuur (i.v.m. koeling), en de gebruikte elektronica. Hoe stabielere de stroomsterkte hoe langer de levensduur. Ook de vochtigheidsgraad van de led omgeving is nog van invloed. Overigens loopt de lichtopbrengst na verloop van tijd wel enigszins terug tot maximaal 70%.



Luminous flux

De hoeveelheid licht(stroom) die een lichtbron oplevert, oftewel de som van al het uitgestraalde licht ongeacht de richting waarin het licht straalt. De Luminous flux waarde wordt vaak uitgedrukt per stroomeenheid (Lm/W) om de efficiëntie van de led uit te drukken. Tronix High Efficiency Panelen scoren met een lichtopbrengst van >130 Lm/Watt hoog in gebruiksefficiëntie, waardoor deze in aanmerking komen voor EIA.



LUX

De hoeveelheid lux is de meest betrouwbare meetwaarde voor verlichting en zegt iets over de hoeveelheid licht (Luminous flux) die er op een bepaald oppervlak terecht komt. 1 lux = 1 Lm/m². Vb: een lichtbron van 1000 Lm, verspreid over 1 m², verlicht die vierkante meter met 1000 Lux. Verspreid over 10m² verlicht die zelfde 1000 Lm slechts 100 Lux. De gestelde Europese normen voor luxwaarden in diverse binnenverlichtingsomgevingen zijn vastgelegd in NEN 1246-1.



Power factor

De power factor geeft de relatie weer tussen het werkelijke vermogen (P) en het schijnbare vermogen (Ps). Hoe lager de power factor, hoe hoger het ongewenste stroomverbruik. Hoge kwaliteit led verlichting heeft een powerfactor van minimaal 0,90 en loopt inmiddels tegen de 0,95 (max. 5% ongewenst stroomverbruik). Inferieure led producten hebben een aanzienlijk lagere power factor; behalve hogere stroomkosten levert dit ook gevaarlijke situaties op door de grote hoeveelheid blindstroom.



UGR

De Unified Glare Rating geeft aan in hoeverre er sprake is van lichthinder of verblinding. De gemiddelde waarde ligt tussen de 15 en de 30. Beneden de 10 is er geen sprake van verblinding.



Communicatieprotocol

Met een grote variatie in aansturing en dimtechnieken zijn de mogelijkheden met het huidige Tronix verlichtingsassortiment eindeloos. Zo beschikken we over DALI, Casambi, ZigBee, DMX, Triac en 1-10V. Toch niet het juiste protocol beschikbaar? Elk armatuur is te leveren met geïntegreerde aansturing in elk gewenst protocol. Vraag ons naar de opties en mogelijkheden.

1 Drivers & Controllers

For the best possible dimming
& controlling results





Sushi LIN

Diverse wijes sushi
3 voor: **17,95**

EXTRA GOED KOOP

ELKE DAG

Drivers & Controllers | Non Dimmable

LED DRIVER | INDOOR | NON DIMMABLE

Input voltage: 220 - 240V
Constant current: 350/700 mA
Power factor: 0,8
Dimmable: No
IP Rate: IP20

Connection type: Terminal block
Isolation: SELV
Ambient temperature: -20°C / +50°C



ART. NR.	CONSTANT CURRENT	POWER	OUTPUT VOLTAGE	SIZE (L X W X H)
215-412	350 mA	20 Watt	2 - 58 Volt	113 x 44 x 28 mm
215-211	700 mA	12 Watt	2 - 12 Volt	99 x 39 x 22 mm
215-212	700 mA	20 Watt	2 - 29 Volt	113 x 44 x 28 mm

PHILIPS DRIVER | OUTPUT PROGRAMMABLE 20/36/50W | NON DIMMABLE

Input voltage: 220 - 240V
Constant current: 150 ~ 500 /
 300 ~ 1050 / 700 ~ 1500 mA
Power factor: 0,9
Dimmable: No

IP Rate: IP20
Connection type: Terminal block
Isolation: SELV
Ambient temperature: -20°C / +50°C

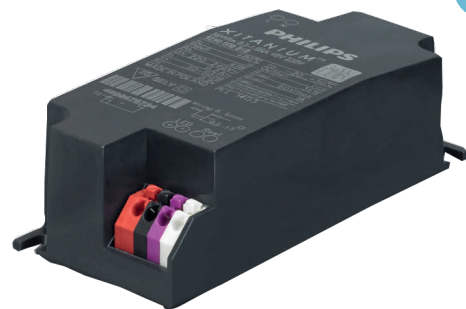

ART. NR.	CONSTANT CURRENT	POWER	OUTPUT VOLTAGE	SIZE (L X W X H)
215-220	150 ~ 500 mA	8,1 - 20 Watt	24 - 54 Volt	97,2/157 x 43 x 30 mm
215-221	300 ~ 1050 mA	16,2 - 36 Watt	24 - 54 Volt	97,2/157 x 43 x 30 mm
215-222	700 ~ 1500 mA	37,8 - 50 Watt	24 - 54 Volt	97,2/157 x 43 x 30 mm



PROGRAMM YOUR PHILIPS DRIVER WITH SIMPLESET®

- Philips LED drivers (output programmable) can now be fast and easily programmed in any desired output with Philips latest technology: **SimpleSet®**.
- SimpleSet® is a certified interface tool that makes wireless configurability possible. All you need is a PC with unique Philips MultiOne software that uses NFC to create any desired output. With this technology, you now only need one LED driver that will suit multiple applications.
- **No MultiOne software available?** Just let us know, we are more than happy to configure your SimpleSet® drivers. sales@tronixlighting.com | T +31 (0) 413 330 380.



Non Dimmable | Drivers & Controllers

POWER SUPPLY | BLOCK TYPE | INDOOR 18 WATT | NON DIMMABLE

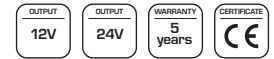

CV

Input voltage: 220 - 240V
Output voltage: 12/24V
Power factor: >0,9
Dimmable: No
IP Rate: IP20

Connection type: Terminal block
Isolation: SELV
Ambient temperature: -20°C / +50°C



ART. NR.	OUTPUT VOLTAGE	POWER	SIZE (L X W X H)
215-002	12 Volt	18 Watt	115 x 45 x 21 mm
215-006	24 Volt	18 Watt	115 x 45 x 21 mm

POWER SUPPLY | SLIM TYPE | INDOOR 30/60/100/150W | NON DIMMABLE



CV

Input voltage: 220 - 240V
Output voltage: 12/24V
Power factor: >0,9
Dimmable: No
IP Rate: IP20

Connection type: Terminal block
Isolation: SELV
Ambient temperature: -20°C / +50°C



ART. NR.	OUTPUT VOLTAGE	POWER	SIZE (L X W X H)
215-005	12 Volt	30 Watt	251 x 30 x 16 mm
215-422	24 Volt	60 Watt	305 x 30 x 17 mm
215-423	24 Volt	100 Watt	312 x 30 x 18,5 mm
215-424	24 Volt	150 Watt	335 x 30 x 21,5 mm

POWER SUPPLY | BLOCK TYPE | INDOOR NON DIMMABLE



CV

Input voltage: 220 - 240V
Output voltage: 12/24V
Power factor: >0,95
Dimmable: No
IP Rate: IP20

Connection type: Terminal block
Isolation: SELV
Ambient temperature: -20°C / +50°C



ART. NR.	OUTPUT VOLTAGE	POWER	SIZE (L X H X W)
215-009	12 Volt	40 Watt	166 x 52 x 24 mm
215-010	12 Volt	75 Watt	184 x 61 x 32 mm
215-011	12 Volt	150 Watt	210 x 67 x 34 mm
215-012	12 Volt	216 Watt	195 x 67 x 31 mm
215-013	12 Volt	264 Watt	215 x 78 x 35 mm
215-414	24 Volt	40 Watt	166 x 52 x 24 mm
215-403	24 Volt	75 Watt	184 x 61 x 32 mm
215-408	24 Volt	150 Watt	210 x 67 x 34 mm
215-409	24 Volt	250 Watt	195 x 67 x 31 mm

Drivers & Controllers | Non Dimmable

POWER SUPPLY | 24V | 9 WATT | SMALL TYPE INDOOR | NON DIMMABLE

Input voltage: 90 - 265V
Output voltage: 24V
Power factor: >0,9
Dimmable: No
IP Rate: IP20

Connection type: Stripped wire
Isolation: SELV
Ambient temperature: -25°C / +50°C

ART. NR.	OUTPUT VOLTAGE	POWER	SIZE (D X H)
215-430	24 Volt	9 Watt	Ø 48 x 20 mm



POWER SUPPLY | OUTDOOR | 4W NON DIMMABLE

Input voltage: 220 - 240V
Output voltage: 12/24V
Power factor: >0,55
Dimmable: No

IP Rate: IP65
Connection type: Stripped wire
Isolation: SELV
Ambient temperature: -20°C / +50°C

ART. NR.	OUTPUT VOLTAGE	POWER	SIZE (L X W X H)
215-081	12 Volt	4 Watt	38 x 27 x 21 mm
215-082	24 Volt	4 Watt	38 x 27 x 21 mm

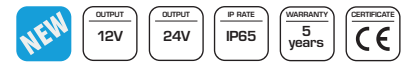

POWER SUPPLY | OUTDOOR | 6W NON DIMMABLE

Input voltage: 220 - 240V
Output voltage: 12/24V
Power factor: >0,55
Dimmable: No

IP Rate: IP20
Connection type: Terminal block
Isolation: SELV
Ambient temperature: -20°C / +50°C

ART. NR.	OUTPUT VOLTAGE	POWER	SIZE (L X W X H)
215-083	12 Volt	6 Watt	50 x 32 x 18,5 mm
215-084	24 Volt	6 Watt	50 x 32 x 18,5 mm



POWER SUPPLY | OUTDOOR | 100/200/320 WATT NON DIMMABLE

Input voltage: 220 - 240V
Output voltage: 12/24V
Power factor: >0,9
Dimmable: No

IP Rate: IP67
Connection type: Stripped wire
Isolation: SELV
Ambient temperature: -20°C / +40°C

ART. NR.	OUTPUT VOLTAGE	POWER	SIZE (L X W X H)
215-315	12 Volt	100 Watt	191 x 70 x 40 mm
215-317	12 Volt	200 Watt	249 x 72 x 40 mm
215-316	24 Volt	100 Watt	249 x 72 x 40 mm
215-318	24 Volt	200 Watt	249 x 72 x 40 mm
215-319	24 Volt	320 Watt	252 x 90 x 44 mm





Bar with Tronix dimmable Led Strips, Twin Pancakes restaurant, Uden - The Netherlands

Drivers & Controllers | Triac Dimmable

LED DRIVER | INDOOR | TRIAC DIMMABLE

Input voltage: 220 - 240V
Constant current: 350/700 mA
Power factor: 0,9
Dimmable: Triac Dimmable
IP Rate: IP20

Connection type: Terminal block
Isolation: SELV
Ambient temperature: -20°C / +50°C



ART. NR.	CONSTANT CURRENT	POWER	OUTPUT VOLTAGE	SIZE (L X W X H)
215-379	350 mA	9 Watt	13 - 26 Volt	109 x 40 x 22 mm
215-380	350 mA	18 Watt	26 - 52 Volt	120 x 45 x 28 mm
215-279	700 mA	9 Watt	10 - 13 Volt	109 x 40 x 22 mm
215-280	700 mA	18 Watt	13 - 26 Volt	120 x 45 x 28 mm
215-281	700 mA	25 Watt	18 - 36 Volt	120 x 45 x 28 mm

LED DRIVER | INDOOR | TRIAC DIMMABLE

Input voltage: 220 - 240V
Constant current: 700/1050 mA
Power factor: >0,95
Dimmable: Triac Dimmable
IP Rate: IP20

Connection type: Terminal block
Isolation: SELV
Ambient temperature: -20°C / +50°C



ART. NR.	CONSTANT CURRENT	POWER	OUTPUT VOLTAGE	SIZE (L X W X H)
215-282	700 mA	40 Watt	28 - 56 Volt	166 x 52 x 24 mm
215-214	1050 mA	40 Watt	19 - 38 Volt	166 x 52 x 25 mm

LED DRIVER MINI | OUTDOOR | TRIAC DIMMABLE



Input voltage: 220 - 240V
Constant current: 350/500/700 mA
Power: 4 Watt
Power factor: 0,9
Dimmable: Triac Dimmable
IP Rate: IP65
Connection type: Stripped wire

Isolation: SELV
Ambient temperature: -20°C / +50°C



ART. NR.	CONSTANT CURRENT	POWER	OUTPUT VOLTAGE	SIZE (L X W X H)
215-320	350 mA	4 Watt	6 - 12 Volt	38 x 27 x 21 mm
215-321	500 mA	4 Watt	4 - 8 Volt	38 x 27 x 21 mm
215-322	700 mA	4 Watt	2 - 6 Volt	38 x 27 x 21 mm
215-323	350 mA	6 Watt	9 - 17 Volt	38 x 27 x 21 mm
215-324	500 mA	6 Watt	6 - 12 Volt	38 x 27 x 21 mm
215-325	700 mA	6 Watt	4 - 9 Volt	38 x 27 x 21 mm

Triac Dimmable | Drivers & Controllers

POWER SUPPLY | 24V | OUTDOOR | 12 WATT TRIAC DIMMABLE



Input voltage: 220 - 240V
Output voltage: 24V
Power factor: >0,95
Dimmable: Triac Dimmable
IP Rate: IP65

Connection type: Stripped wire
Isolation: SELV
Ambient temperature: -20°C / +50°C

ART. NR.	OUTPUT VOLTAGE	POWER	SIZE (L X W X H)
215-019	24 Volt	12 Watt	50 x 48 x 24 mm

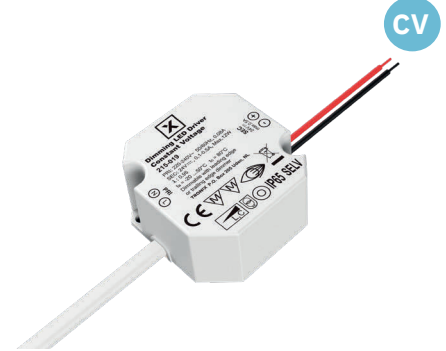

POWER SUPPLY | 24V | INDOOR | 25 WATT TRIAC DIMMABLE



Input voltage: 220 - 240V
Output voltage: 24V
Power factor: >0,9
Dimmable: Triac Dimmable
IP Rate: IP20

Connection type: Terminal block
Isolation: SELV
Ambient temperature: -20°C / +50°C

ART. NR.	OUTPUT VOLTAGE	POWER	SIZE (L X W X H)
215-404	24 Volt	25 Watt	122 x 52 x 30 mm



POWER SUPPLY | BLOCK TYPE | INDOOR 50/100W | TRIAC DIMMABLE



Input voltage: 220 - 240V
Output voltage: 12/24V
Power factor: >0,9
Dimmable: Triac Dimmable
IP Rate: IP20

Connection type: Terminal block
Isolation: SELV
Ambient temperature: -20°C / +50°C

ART. NR.	OUTPUT VOLTAGE	POWER	SIZE (L X W X H)
215-015	12 Volt	50 Watt	166 x 52 x 24 mm
215-016	12 Volt	100 Watt	210 x 67 x 34 mm
215-014	24 Volt	50 Watt	184 x 61 x 32 mm
215-003	24 Volt	100 Watt	210 x 67 x 34 mm



POWER SUPPLY | 24V | OUTDOOR | 200 WATT TRIAC DIMMABLE



Input voltage: 220 - 240V
Output voltage: 24V
Power factor: >0,95
Dimmable: Triac Dimmable
IP Rate: IP67

Connection type: Stripped wire
Isolation: SELV
Ambient temperature: -20°C / +50°C

ART. NR.	OUTPUT VOLTAGE	POWER	SIZE (L X H X W)
215-004	24 Volt	200 Watt	249 x 72 x 40 mm





Hallway at modern apartment with Tronix Trimless Spots and Triac dimmers.

Triac Dimmable | Drivers & Controllers

LED DIMMER UNIVERSAL | TRAILING EDGE 2-350W

Many different brands of plates can be fitted on this universal LED dimmer (plate excluded).



Input voltage: 220 - 240V

Dimming method: Trailing edge / Triac

Power: 2 - 350W

IP rate: IP20

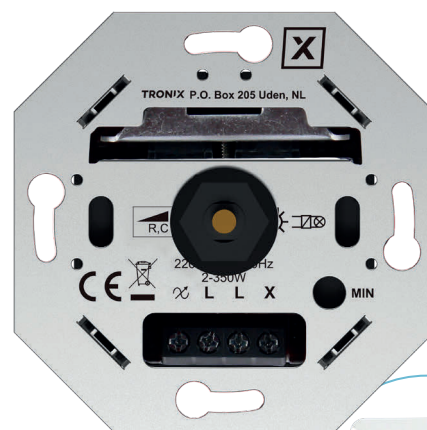

ART. NR.	MIN.-MAX. LOAD	LENGTH	WIDTH	MOUNTING DEPTH
215-131	2 - 350 Watt	70 mm	70 mm	24 mm

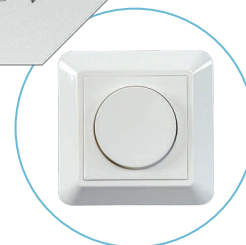

Art. nr. 215-132
Plate for 215-131

LED DIMMER DOUBLE | TRAILING EDGE 2X 2-100W

Including plate/cover frame and dimmer buttons.



Input voltage: 220 - 240V

Dimming method: Trailing edge / Triac

Power: 2 X 2 - 100W

IP rate: IP20

ART. NR.	MIN-MAX. LOAD	LENGTH	WIDTH	MOUNTING DEPTH
215-135	2X 2 - 100 Watt	71 mm	71 mm	27 mm



Cover and frame as pictured included. The dimmer is also suitable for other 55 mm frames from other brands

Drivers & Controllers | Multi Dimmable

LED DRIVER | 200~350mA | 8,4-10W | MULTI DIMMABLE INDOOR

Driver with 4 different dimming methods.

- Input voltage:** 220 - 240V
- Constant current:** 200 mA - 350 mA
- Power factor:** >0,9
- Dimmable:** Dali / Push / Triac / 0/1-10V
- IP Rate:** IP20
- Size (L x W x H)::** 104 x 53 x 30 mm
- Connection type:** Terminal block
- Isolation:** SELV
- Ambient temperature:** -20°C / +45°C

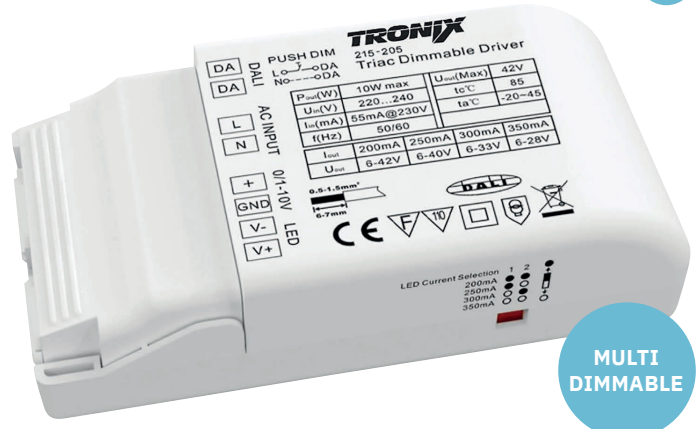
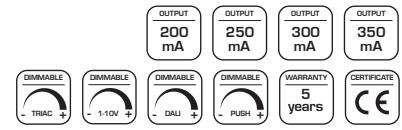

ART.NR	CONSTANT CURRENT	POWER	OUTPUT VOLTAGE	DALI	PUSH	TRIAC	1-10V
215-205	200mA	8,4W	6 - 42 Volt	Yes	Yes	Yes	Yes
	250mA	10W	6 - 40 Volt	Yes	Yes	Yes	Yes
	300mA	10W	6 - 33 Volt	Yes	Yes	Yes	Yes
	350mA	10W	6 - 28 Volt	Yes	Yes	Yes	Yes

Tronix LED Driver Multi Dimmable

What is so extraordinary about this Triac dim driver, is that it's designed for a large number of different interfaces, such as DALI, Push and Triac, as well as 0/1-10V dim interfaces. As a result, this driver is able to work with different operating systems.

FEATURES:

- Equipped with a combined output: an Amplitude dimming output (100% -10%) and a PWM dimming output (10% -1%).
- Power factor of >0.9, high efficiency >83%
- Very smooth dimming, back dimming possible up to 1% without flicker effect or buzzing sound.
- Automatic assignment of 1 Dali address by Dali masters.
- Complies with IEC 62386-101, IEC 62386-102, IEC 62386-207 standards.

Tronix LED Driver Multi Dimmable

Het bijzondere aan deze Triac-dimdriver is dat deze is ontworpen met zowel DALI, Push en Triac, als 0/1-10V diminterfaces, en hierdoor met verschillende besturingssystemen kan werken.

KENMERKEN:

- Voorzien van een gecombineerde uitgang: een Amplitude-dimuitgang (100% -10%) en een PWM-dimming uitgang (10% -1%).
- Power factor van >0.9, hoge efficiëntie >83%
- Zeer soepele dimming, terug dimmen tot 1% mogelijk zonder flikkereffect of zoemgeluid.
- Automatische toewijzing van 1 Dali-adres door Dali-masters mogelijk.
- Voldoet aan IEC 62386-101, IEC 62386-102, IEC 62386-207 normering.

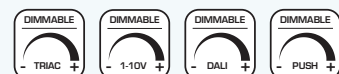

Multi Dimmable | Drivers & Controllers

LED DRIVER | 180~1500mA | 8,6-50W | MULTI DIMMABLE INDOOR

Driver with 4 different dimming methods.

- Input voltage:** 200 - 240V
- Constant current:** 180 - 1500mA
- Power factor:** >0,9
- Dimmable:** Dali / Push / Triac / 0/1-10V
- IP Rate:** IP20
- Size (L x W x H):** 164,6 x 83 x 34,5 mm
- Connection type:** Terminal block
- Isolation:** SELV
- Ambient temperature:** -20°C / +45°C

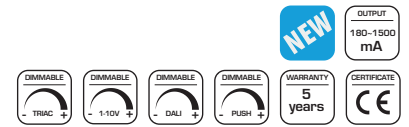

NEW
OUTPUT
180-1500
mA

CC



MULTI
DIMMABLE

ART.NR	CONSTANT CURRENT	POWER	OUTPUT VOLTAGE	DALI	PUSH	TRIAC	1-10V
215-206	180mA	8,6W	8 - 48 Volt	Yes	Yes	Yes	Yes
	200 mA	9,6W	8 - 48 Volt	Yes	Yes	Yes	Yes
	250 mA	12W	8 - 48 Volt	Yes	Yes	Yes	Yes
	300 mA	14,4W	8 - 48 Volt	Yes	Yes	Yes	Yes
	350 mA	16,8W	8 - 48 Volt	Yes	Yes	Yes	Yes
	400 mA	19,2W	8 - 48 Volt	Yes	Yes	Yes	Yes
	450 mA	21,6W	8 - 48 Volt	Yes	Yes	Yes	Yes
	500 mA	24W	8 - 48 Volt	Yes	Yes	Yes	Yes
	600 mA	28,8W	8 - 48 Volt	Yes	Yes	Yes	Yes
	700 mA	33,6W	8 - 48 Volt	Yes	Yes	Yes	Yes
	900 mA	43,2W	8 - 48 Volt	Yes	Yes	Yes	Yes
	1000 mA	48W	8 - 48 Volt	Yes	Yes	Yes	Yes
	1050 mA	50W	8 - 47 Volt	Yes	Yes	Yes	Yes
	1200 mA	50W	8 - 41 Volt	Yes	Yes	Yes	Yes
	1400 mA	50W	8 - 35 Volt	Yes	Yes	Yes	Yes
	1500 mA	50W	8 - 33 Volt	Yes	Yes	Yes	Yes

Drivers & Controllers | 0/1-10V

LED DRIVER 1-10V | 350~1050 MA | 25/40W | LCM-25/40

Input voltage: 180 - 277V / 180 - 295V
Constant current: 350 ~ 1050 mA
Power factor: >0,9
Dimmable: 1-10V
IP Rate: IP20

Connection type: Terminal block
Isolation: SELV
Ambient temperature: -20°C / +45°C

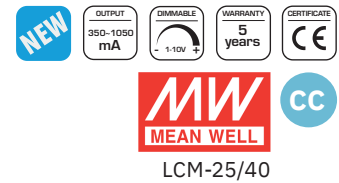

ART.NR	CONSTANT CURRENT	POWER	OUTPUT VOLTAGE	SIZE (L X W X H)
215-517	350 ~ 1050 mA	18,9 - 25W	6 - 54 Volt (350 mA)	105 x 68 x 21 mm
215-509	350 ~ 1050 mA	35 - 40W	2 - 100 Volt (350 mA)	123,5 x 81,5 x 23 mm

DIMMING MODULE | 700 mA | 0/1-10V

To dim constant current 700mA by 0/1-10 Volt.

Input voltage: 12 - 36V
IP rate: IP20
Connection type: Terminal block



ART. NR.	POWER OUTPUT	MAX. CURRENT	DIMMING	SIZE (L X W X H)
214-137	8,4 W (12V) 16,8 W (24V) 25,2 W (36V)	700 mA	0/1-10V	115 x 36 x 21 mm

DIMMING MODULE | 12-36V | 0/1-10V

To dim 12 - 36 constant voltage by 0/1-10 Volt.

Input voltage: 12 - 36V
IP rate: IP20
Connection type: Terminal block

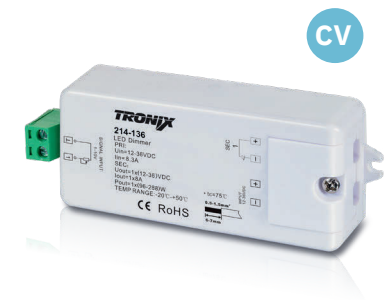

ART. NR.	POWER OUTPUT	MAX. CURRENT	DIMMING	SIZE (L X W X H)
214-136	96 W (12V) 192 W (24V) 288 W (36V)	1x 8000 mA	0/1-10V	115 x 36 x 21 mm

RF TO 0/1-10V/PWM DIMMING MODULE | 20mA

To connect RF to 0/1-10V/PWM dimmable lamps or drivers.

Input voltage: 100 - 240V
IP Rate: IP20
Connection type: Terminal block



ART. NR.	MAX. SWITCHING CAPACITY	DIMMING	SIZE (L X W X H)
214-179	1x 5000 mA	0/1-10V (max 20 mA)	170 x 59 x 29 mm

Use in combination with 214-145 or other remote controls

0/1-10V | Drivers & Controllers

LED DRIVER | SOLODRIVE | 0/1-10V

SOLOdrive offers industry-best Natural Dimming to dark, with any dimmer, in any application, <0,1% dimming.

Input voltage: 120 - 250V
Power factor: >0,95
Dimmable: Dali Dimmable
IP Rate: IP20

Connection type: Terminal block
Isolation: SELV
Ambient temperature: -20°C / +50°C



eldoLED® cc



ART. NR.	TYPE	CONSTANT CURRENT	POWER	OUTPUT VOLTAGE	SIZE (L X W X H)
215-621	241/A	150 ~ 1050 mA	6 - 20 Watt	2 - 40 Volt	160 x 41,5 x 30,5 mm
215-622	361/A	150 ~ 1400 mA	8,25 - 30 Watt	2 - 55 Volt	210 x 40 x 33,5 mm
215-623	561/A	150 ~ 1400 mA	8,25 - 50 Watt	2 - 55 Volt	152,5 x 76,2 x 30,1 mm

LED DRIVER | ECODRIVE | 0/1-10V

Programmable digital ECODrive LED driver providing standard LED fixtures with the smoothest flicker-free dimming to 1% light output.

Input voltage: 220 - 240V
Power factor: >0,95
Dimmable: Dali Dimmable
IP Rate: IP20

Connection type: Terminal block
Isolation: SELV
Ambient temperature: -20°C / +50°C



eldoLED® cc



ART. NR.	TYPE	CONSTANT CURRENT	POWER	OUTPUT VOLTAGE	SIZE (L X W X H)
215-601	241/A	150 ~ 1050 mA	6 - 20 Watt	2 - 40 Volt	160 x 41,5 x 30,5 mm
215-602	361/A	150 ~ 1400 mA	8,25 - 30 Watt	2 - 55 Volt	210 x 40 x 33,5 mm
215-603	561/A	150 ~ 1400 mA	8,25 - 50 Watt	2 - 55 Volt	153 x 76,2 x 30,5 mm

LED DRIVER | LINEARDRIVE | 0/1-10V

To dim 12V or 28V 0/1-10V - constant voltage.

Input voltage: 12/28V
IP rate: IP20
Connection type: Terminal block

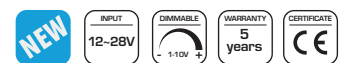

eldoLED® cv



ART. NR.	TYPE	DALI TYPE	MAX. CURRENT	POWER OUTPUT	ZONES	OUTPUTS	SIZE (L X W X H)
214-354	211/D	DT6	8.000 mA	96/192 Watt	1	2	153 x 50 x 23 mm

Drivers & Controllers | 0/1-10V

LED DIMMER 0/1-10V | INDOOR | RECESSED

Many different brands of plates can be fitted on this universal 0/1-10V dimmer (plate excluded).



Dimming method: 0/1-10 Volt

IP Rate: IP20

Length: 83.5 mm

Width: 83.5 mm

Height: 44 mm

Connection type: Terminal block

Material: Aluminium

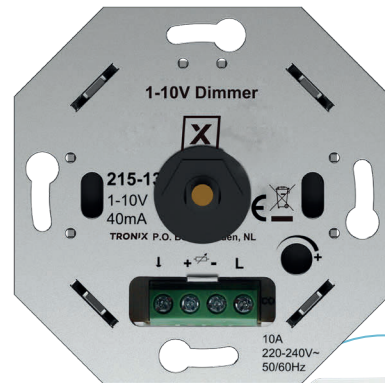

215-132
Plate for 215-133

ART. NR.	DIMMING
215-133	0/1-10V



Tronix universal LED dimmers: Perfectly stable

Every moment in the day asks for just that precise amount of light intensity and ambiance. Dimming LED can be done in many ways, provided that the LED dimmer and driver are a proper match with the light source.

DIMMING WITHOUT PROBLEMS?

Then use our universal Tronix LED Dimmers, compatible with all major brands in switch materials. Make sure the light source stays within the power range of the LED Dimmer, and the total wattage of the light source 10% below the maximum power. Tronix universal Dimmers Triac, 1-10V or Dali, are dimming back to <10% and remain stable.

FIND OUT MORE ABOUT LED DIMMING AND THE BEST CHOICE FOR YOUR APPLICATION?

We are happy to advise and assist you at sales@tronixlighting.com | +31 (0)413 33 03 80

Elk moment van de dag vraagt om precies die juiste hoeveelheid licht en sfeer. Het dimmen van LED kan op vele manieren, mits de keuze van de LED dimmer én voeding zijn afgestemd op de lichtbron.

PROBLEEMLOOS DIMMEN?

Gebruik dan onze universele Tronix LED Dimmers, compatibel met alle grote merken schakelmateriaal. Zorg ervoor dat de lichtbron binnen het wattagebereik van de dimmer blijft, en het liefst 10% onder het maximale vermogen. Tronix universele LED Dimmers Triac, 1-10V of Dali, dimmen terug tot <0% en blijven stabiel.

MEER WETEN OVER HET DIMMEN VAN LED EN DE BESTE KEUZE VOOR UW TOEPASSING?

Wij helpen u graag verder op sales@tronixlighting.com | +31 (0)413 33 03 80

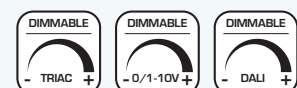



0/1-10V controllable spots - Kaeve Uden, The Netherlands

Drivers & Controllers | DALI

LED DRIVER | DALI DIMMABLE | 12W

To dim 100-700mA max. 12W.

Input voltage: 200 - 240V
Power factor: >0,95
Dimmable: Dali Dimmable
IP Rate: IP20

Connection type: Terminal block
Isolation: SELV
Ambient temperature: -20°C / +45°C



ART. NR.	CONSTANT CURRENT	POWER	OUTPUT VOLTAGE	SIZE (L X W X H)
215-272	100 mA	5,2 Watt	6 - 52 Volt	135 x 35 x 20 mm
	150 mA	7,8 Watt	6 - 52 Volt	
	200 mA	10,4 Watt	6 - 52 Volt	
	250 mA	12 Watt	6 - 48 Volt	
	300 mA	12 Watt	6 - 40 Volt	
	350 mA	12 Watt	6 - 34 Volt	
	400 mA	12 Watt	6 - 30 Volt	
	450 mA	12 Watt	6 - 26 Volt	
	500 mA	12 Watt	6 - 24 Volt	
	550 mA	12 Watt	6 - 21 Volt	
	600 mA	12 Watt	6 - 20 Volt	
	650 mA	12 Watt	6 - 18 Volt	
	700 mA	12 Watt	6 - 17 Volt	

PHILIPS DRIVER | DALI DIMMABLE | 20/36W

Output programmable LED driver via Philips SimpleSet.

Input voltage: 220 - 240V
Power factor: >0.90
Dimmable: Dali Dimmable
IP Rate: IP20

Connection type: Terminal block
Isolation: SELV
Ambient temperature: -20°C / +50°C



ART. NR.	CONSTANT CURRENT	POWER	OUTPUT VOLTAGE	SIZE (L X W X H)
215-266	150 ~ 500 mA	8,1 - 20 Watt	24 - 54 Volt	97,2/157 x 43 x 30 mm
215-265	300 ~ 1050 mA	16,2 - 36 Watt	24 - 54 Volt	97,2/157 x 43 x 30 mm

DALI - PROFESSIONAL LIGHTING CONTROL WITH INTERNATIONAL STANDARDS

- **DALI is a two-way communication system** that allows individual LED drivers and ballasts to “talk” to the user, and allows the user to “talk” back via DALI controllers
- **DALI is an international protocol**, so flexible to implement cross-border in both large and small businesses, such as retail stores, shops, offices and schools
- **DALI makes it easier to control individual light sources** and to individually set and manage the desired parameters. This allows energy to be saved and for every room within a building to have its desired light color and intensity (brightness)
- **Ask us for the possibilities** with DALI light controlling or any other controlling system, we will be happy to assist you with the right choice for your project. sales@tronixlighting.com | T +31 (0) 413330380

DALI | Drivers & Controllers

LED DRIVER | SOLODRIVE | DALI

SOLOdrive offers industry-best Natural Dimming to dark, with any dimmer, in any application, <0,1% dimming.

Input voltage: 120 - 250V
Power factor: >0,95
Dimmable: Dali Dimmable
IP Rate: IP20

Connection type: Terminal block
Isolation: SELV
Ambient temperature: -20°C / +50°C



eldoLED® CC



ART. NR.	TYPE	CONSTANT CURRENT	POWER	OUTPUT VOLTAGE	SIZE (L X W X H)
215-268	240/A	150 ~ 1050 mA	6 - 20 Watt	2 - 40 Volt	160 x 41,5 x 30,5 mm
215-625	360/A	150 ~ 1050 mA	8,25 - 30 Watt	2 - 55 Volt	210 x 40 x 33,5 mm
215-271	560/A	150 ~ 1400 mA	8,25 - 50 Watt	2 - 55 Volt	152,5 x 76,2 x 30,1 mm

LED DRIVER | ECODRIVE | DALI

Programmable digital ECoDrive LED driver providing standard LED fixtures with the smoothest flicker-free dimming to 1% light output.

Input voltage: 220 - 240V
Power factor: >0,95
Dimmable: Dali Dimmable
IP Rate: IP20

Connection type: Terminal block
Isolation: SELV
Ambient temperature: -20°C / +50°C



eldoLED® CC



ART. NR.	TYPE	CONSTANT CURRENT	POWER	OUTPUT VOLTAGE	SIZE (L X W X H)
215-267	240/A	150 ~ 1050 mA	6 - 20 Watt	2 - 40 Volt	160 x 41,5 x 30,5 mm
215-605	360/A	150 ~ 1400 mA	8,25 - 30 Watt	2 - 55 Volt	210 x 40 x 33,5 mm
215-606	560/A	150 ~ 1400 mA	8,25 - 50 Watt	2 - 55 Volt	153 x 76,2 x 30,5 mm

LED DRIVER | DUALDRIVE | DALI

DUALdrive with two independently programmable outputs for Tunable white fixtures.

Input voltage: 220 - 240V
Power factor: >0,95
Dimmable: Dali Dimmable
IP Rate: IP20

Connection type: Terminal block
Isolation: SELV
Ambient temperature: -20°C / +50°C



eldoLED® CC



ART. NR.	TYPE	DALI TYPE	CONSTANT CURRENT	POWER	OUTPUT VOLTAGE	SIZE (L X W X H)
215-641	20MA-E2Z0D	DT6	150 ~ 1050 mA	6 - 20 Watt	2 - 40 Volt	183,4 x 41,3 x 30 mm
215-642	20MA-E2Z0C	DT8	150 ~ 1050 mA	6 - 20 Watt	2 - 40 Volt	183,4 x 41,3 x 30 mm
215-646	560/A	DT6	150 ~ 1400 mA	8,25 - 50 Watt	2 - 55 Volt	152 x 76,2 x 30,1 mm
215-269	562/A	DT8	150 ~ 1400 mA	8,25 - 50 Watt	2 - 55 Volt	152 x 76,2 x 30,1 mm

Drivers & Controllers | DALI

LED DRIVER | POWER DRIVE | 600W

The POWERdrive 6060/R integrates 32 drivers into one, which can be controlled via DMX, DALI or 0-10V. You can install up to 32 fixtures (1-32 (DMX), 1-4 (DALI), 1 (0-10V) on the POWERdrive 6060/R, making this an extremely "clean", professional choice.

Input voltage: 120 - 230V
Power factor: >0,9
Dimmable: Dali/DMX/RDM/0-10V
IP Rate: IP20

Connection type: Terminal block
Isolation: SELV
Ambient temperature: -20°C / +50°C

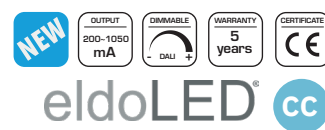

ART. NR.	TYPE	DALI TYPE	CONSTANT CURRENT	POWER	OUTPUT VOLTAGE	SIZE (L X W X H)
215-685	PW6060R1	DT6	200 ~ 1050 mA	600 Watt	2 - 55 Volt	482,6 x 325 x 44,5 mm

DALI CONTROLLER | LINEAR DRIVE | DALI

To dim 12V or 24V DALI fixtures or ledstrips.

Input voltage: 12 - 24V
IP rate: IP20
Connection type: Terminal block

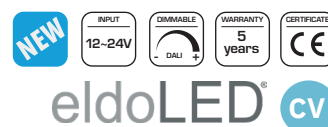

ART. NR.	TYPE	DALI TYPE	MAX. CURRENT	POWER OUTPUT AT 24V	ZONES	OUTPUTS	SIZE (L X W X H)
214-351	210/D1	DT6	8.000 mA	192 Watt	1	2	153 x 50 x 23 mm
214-350	720/D	DT6	24.000 mA	720 Watt	4	4	153 x 50 x 23 mm
214-352	100/A	DT6	4000 mA	96 Watt	4	4	388 x 42 x 30 mm
214-355	220/D	DT6	8000 mA	192 Watt	2	2	153 x 30 x 23 mm
214-356	200D-D2Z2C	DT8	8000 mA	192 Watt	2	2	153 x 50 x 23 mm
214-357	200D-D2Z2D	DT6	8000 mA	192 Watt	2	2	153 x 50 x 23 mm

Incredibly stable dimming eldoLED®

There's a new world-class driver brand in our range of LED products: eldoLED. eldoLED drivers eliminate any perceptible flicker (it even has a patent for it) and are incredibly reliable, stable dimmers.

And that's not all, because eldoLED drivers have some other excellent features:

- Stable dimming range (especially at the low end of the range, down to 0.1%)
- Ignorable inrush current, lower than the rated current
- Total Harmonic Dissonance (THD) <20% during dim.
- Adjustable dimming curve (logarithmic, linear, soft linear or square)
- HD TV Studio Camera Compatible

More information? Contact us for custom-made advice.

We hebben een nieuwe wereldtopper verwelkomd in ons LED-assortiment: eldoLED. eldoLED drivers elimineren iedere waarneembare flikkering en zijn ongekend betrouwbaar in stabiel dimmen.

Daarnaast blinken de eldoLED drivers uit door onder andere:

- Stabiel dimbereik (vooral in het lage gebied tot 0.1%)
- Verwaarloosbare inschakelstroom, lager dan nominaalstroom
- Totale Harmonische Vorming <20% tijdens dimmen
- Instelbare dimcurve (logaritmic, linear, soft linear of square)
- Geschikt voor HD TV camera studio's

Meer weten? Neem contact met ons op voor advies op maat. sales@tronixlighting.com | +31 (0)413 33 03 80

DALI | Drivers & Controllers

DIMMING MODULE | 12-36V | DALI

To dim 12 - 36V DALI fixtures.

Input voltage: 12 - 36V

IP rate: IP20

Connection type: Terminal block



CV



ART. NR.	MAX. CURRENT	POWER OUTPUT	DIMMING	SIZE (L X W X H)
214-156	1x 8000 mA	96W (12V) 192W (24V) 288W (36V)	DALI/push dim	95 x 36 x 21 mm

DIMMING MODULE | 230V | DALI

To connect DALI to Triac controllable lamps.

Input voltage: 100 - 240V

IP rate: IP20

Connection type: Terminal block

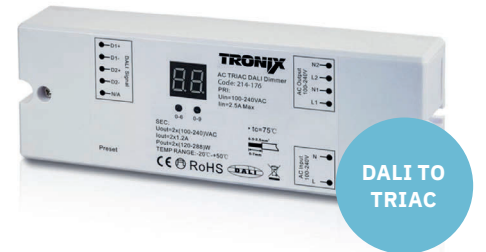

ART. NR.	MAX. CURRENT	POWER OUTPUT	DIMMING	SIZE (L X W X H)
214-176	2x 1200 mA	120W (110V) 288W (220V)	DALI	170 x 59 x 29 mm

DALI TO TRIAC

DIMMING MODULE | 230V | DALI

To connect DALI to Triac controllable lamps.

Input voltage: 100 - 240V

IP rate: IP20

Connection type: Terminal block

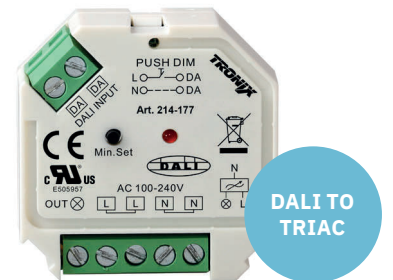

ART. NR.	MAX. CURRENT	POWER OUTPUT	DIMMING	SIZE (L X W X H)
214-177	1x 1800 mA	110W (100V) 220W (240V)	DALI/push dim	45,5 x 45 x 20,3 mm

DALI TO TRIAC

LED DIMMER DALI | INDOOR | RECESSED

Many different brands of plates can be fitted on this universal DALI dimmer (plate excluded).

Dimming method: Dali

IP Rate: IP20

Connection type: Terminal block

Material: Aluminium

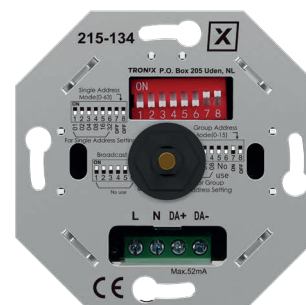

215-132
Plate for 215-134

ART. NR.	DIMMING	SIZE (L X W X H)
215-134	Dali	83,5 x 83,5 x 44 mm

PHILIPS DRIVER | OUTPUT PROGRAMMABLE | 20W/36W CASAMBI

Input voltage: 220 - 240V
Constant current: 150 ~ 500 / 300 ~ 1050 mA
Power factor: 0,9
Dimmable: Yes

IP Rate: IP20
Connection type: Terminal block
Isolation: SELV
Ambient temperature: -20°C / +50°C



CASAMBI



ART. NR.	CONSTANT CURRENT	MAX. POWER	OUTPUT VOLTAGE	SIZE (L X W X H)
215-295	150 ~ 500 mA	8,1 - 20 Watt	24 - 54 Volt	92,2 x 43 x 30 mm
215-296	300 ~ 1050 mA	16,2 - 36 Watt	24 - 54 Volt	97,2 x 43 x 30 mm

SimpleSet

BLUETOOTH | CASAMBI MODULE

This Casambi module makes eldoLED ECOdrivers, SOLOdrivers and DUALdrivers Casambi ready (can be named and mapped in the Casambi application).

Input voltage: 4 - 6,5V
IP rate: IP20

ART. NR.	SUITABLE FOR	SIZE (L X W X H)
214-231	ECOdrive, SOLOdrive	73,2 x 19 x 13 mm
214-232	DUALdrive	73,2 x 19 x 13 mm



CASAMBI eldoLED

CASAMBI Easy Modern Light Control

Casambi is an advanced light system based on Bluetooth low energy and the only wireless low power technology that is used in all modern smartphones, tablets and even smart watches. It is a winning, user-friendly solution with minimal hardware and low implementation costs.

The free Casambi app works as a user interface in Casambi systems, both as a configuration tool and a gateway. How it works? Just turn on bluetooth on your (mobile) device and start controlling your lights! Turn them on or off, pre-set your favorite RGB color, adjust the light color and intensity for just that right ambiance, and choose different lighting setting for different areas at the same time. Easy as that!

More information? Contact us for custom-made advice.

CASAMBI



*Casambi User Guide

Casambi is een geavanceerd lichtstelsel op basis van Bluetooth met de enige draadloze low power technologie die wordt toegepast in smart phones, tablets en zelfs smart watches. Het is een winnende, gebruiksvriendelijke oplossing, met minimale hardware- en implementatiekosten.

De gratis Casambi-app werkt als een gebruikersinterface in het Casambi-systeem, zowel als configuratie tool en als gateway. En nu komt het mooiste: dit systeem communiceert ook met IOS en Android apparaten! Hoe het werkt? Zet gewoon Bluetooth aan op je device en begin met het besturen van je verlichting! Zet 'm aan of uit, stel je favoriete RGB kleur in, pas de lichtkleur en intensiteit aan op de perfecte ambiance, en kies verschillende light settings voor verschillende ruimtes op hetzelfde moment. Zo makkelijk is het!

Meer weten? Neem contact met ons op voor advies op maat. sales@tronixlighting.com | +31 (0)413 33 03 80

CASAMBI RECEIVER | 230V | 150W

Input voltage: 85 - 240V
Max. current: 650 mA
IP rate: IP20
Connection type: Terminal block



CASAMBI



ART. NR.	POWER OUTPUT	SIZE (L X W X H)
214-206	75W (115V) 150W (240V)	75 x 38 x 22 mm

CASAMBI RECEIVER | 12-24V | 72-144W

Suitable for 1-4 channels RGB, RGBW, CCT.

Input voltage: 12 - 24V
Max. current: 4x 1500 mA
IP rate: IP20
Connection type: Terminal block



CASAMBI



ART. NR.	POWER OUTPUT	SIZE (L X W X H)
214-205	72W (12V) 144W (24V)	73 x 30 x 13 mm

CASAMBI SENSOR | MOTION + LIGHT BLACK & WHITE

Input voltage: 220 - 240V
IP rate: IP44 (front)
Size: 73 x Ø38 (Ø25 mm mounting hole)
Connection type: Stripped wire



CASAMBI



ART. NR.	HOUSING COLOR	MAX. LOAD	DETEC. RADIUS	DETEC. RANGE	MOUNTING HEIGHT
214-202	○ White	64 zones	100°	max. 7 meter	3 meter
214-203	● Black	64 zones	100°	max. 7 meter	3 meter

CASAMBI WALL SWITCH

With electrodynamic energy generator (no battery required). Supplied with frame 'Opus 55 inform', but can be replaced with other 55x55 mm switch series.

IP rate: IP20
Size: 81 x 81 x 14 mm



CASAMBI



ART. NR.	SWITCH	MAX. LOAD	RANGE
214-204	Single	2 zones	<10 meter
214-199	Double	4 zones	<10 meter

Drivers & Controllers | Dimmit

DIMMIT BT 0/1-10V | DALI DT6/DT8 DIMMING MODULE

Dimmit (bluetooth) to Dali / 0/1-10V.

Input voltage: 110 - 240V
Max. switching current: 1x 5000 mA
IP rate: IP20
Connection type: Terminal block



Dimmit

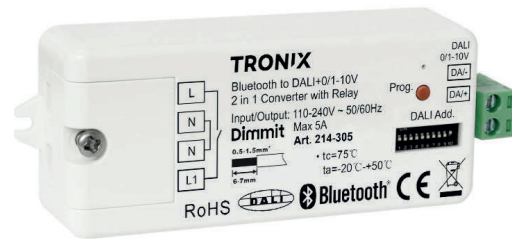

ART. NR.	MAX. SWITCHING CURRENT	DIMMING	SIZE (L X W X H)
214-305	1x 5000 mA	0/1-10V / DALI	95 x 37 x 20 mm

DIMMIT WIFI+RF RECEIVER | 12-24V

RGBTW/RGBW/RGB/TW.

Input voltage: 12 - 24V
Max. current: 5x 4.000 mA
IP rate: IP20
Connection type: Terminal block



Dimmit



Combine with any RGB(W or TW) remote control on P.42

ART. NR.	POWER OUTPUT	SIZE (L X W X H)
214-315	5x 48W (12V) 5x 96W (24V)	145 x 46,5 x 16 mm

DIMMIT | WIFI RECEIVER | 100-240V PHASE-CUT DIM | RECESSED

Suitable for 86x86 mm wall boxes. Can be operated with a standard/universal push button, be controlled with the Dimmit app.

Input voltage: 100 - 240V
IP rate: IP20
Connection type: Terminal block



Dimmit



ART. NR.	MAX. CURRENT	POWER OUTPUT	SIZE (L X W H X)
214-300	1800 mA	100W (110V) 200W (220V)	45,5 x 45 x 20,3 mm

NEW

Tronix by Dimmit: the all-in-one app for smart lighting control



Dimmit by Tronix is an all-in-one app that allows you to control all your smart lighting, dimmers and other smart products. Dimmit is compatible with all your existing smart lighting and voice controllers such as Alexa or Homey.

Changing the colour of your lighting? Accurate dimming? Setting Scenes? These features are pretty standard nowadays. That's why Dimmit does more. You can link events to actions. Do you want your outdoor lights to switch on an hour before sunset every day? What about having the light colour in your living room change as soon as outdoor temperatures start to drop? Or having your lights switched on automatically while you're on holiday? You name it, Dimmit does it.

Dimmit products can be teached in directly into the Dimmit app without an external gateway or bridge.

More information about Dimmit and the possibilities? Contact us.

Dimmit by Tronix is een all-in-one-app, waarmee je al je smart verlichting, dimmers en andere smart producten bedient. Aan te sluiten op al je bestaande smart-verlichting en compatible met spraak gestuurde controllers als Alexa of Homey.

De kleur van je verlichting veranderen? Nauwkeurig dimmen? Scenes bepalen? Als gebruiker is dat vanzelfsprekend. Daarom gaat Dimmit verder. Je combineert gebeurtenissen aan acties. Wil je dat iedere dag een uur voor zonsondergang je buitenverlichting inschakelt? Dat de lichtkleur van de lampen in je woonkamer verandert zodra het buiten kouder wordt? Dat je verlichting automatisch inschakelt tijdens je vakantie? You name it, Dimmit does it.

Dimmit artikelen kunnen direct in de Dimmit app ingeleerd worden zonder externe gateway of bridge.

Meer weten over Dimmit en de mogelijkheden? Neem contact met ons op sales@tronixlighting.com +31 (0)413 33 03 80

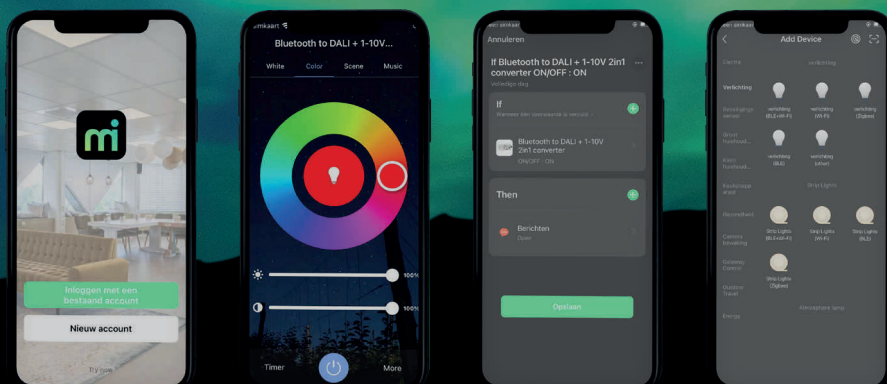

Full experience with Dimmit controlling components. More will be added to the product range soon!

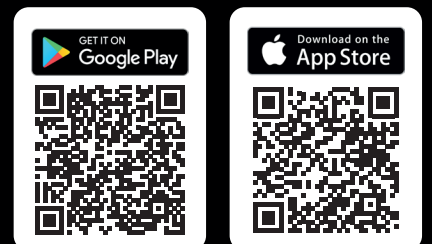

ZIGBEE DRIVER | 50W | 250~1500 mA | TUNABLE WHITE

Suitable for 2 channels, Tunable white.

- Input voltage:** 200 - 240V
- Constant current:** 250 mA ~ 1500 mA
- Power factor:** 0.9
- Dimmable:** Yes
- IP Rate:** IP20
- Connection type:** Terminal block
- Isolation:** SELV
- Ambient temperature:** -20°C / +45°C

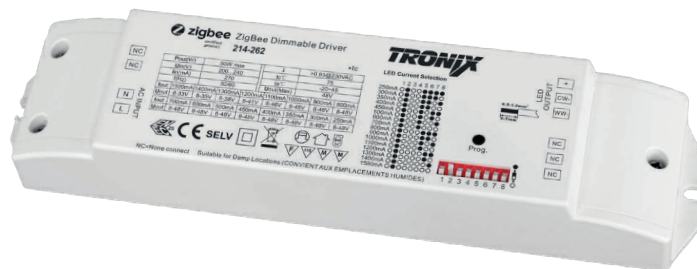

ART. NR.	CONSTANT CURRENT	POWER	OUTPUT VOLTAGE	SIZE (L X W X H)
214-262	250 mA	12 Watt	8 - 48 Volt	210 x 50 x 32 mm
	300 mA	14,4 Watt	8 - 48 Volt	
	350 mA	16,8 Watt	8 - 48 Volt	
	400 mA	19,2 Watt	8 - 48 Volt	
	450 mA	21,6 Watt	8 - 48 Volt	
	500 mA	24 Watt	8 - 48 Volt	
	600 mA	28,8 Watt	8 - 48 Volt	
	700 mA	33,6 Watt	8 - 48 Volt	
	800 mA	38,4 Watt	8 - 48 Volt	
	900 mA	43,2 Watt	8 - 48 Volt	
	1000 mA	48 Watt	8 - 48 Volt	
	1100 mA	50,6 Watt	8 - 46 Volt	
	1200 mA	49,2 Watt	8 - 41 Volt	
	1300 mA	49,4 Watt	8 - 38 Volt	
	1400 mA	49 Watt	8 - 35 Volt	
	1500 mA	49,5Watt	8 - 33 Volt	



ZigBee® Limitless control system

ZigBee is a communication protocol that can connect smart devices with each other, creating a so-called 'mesh' network. ZigBee is smart, safe and has a low energy consumption.

The difference with other protocols is that ZigBee not only communicates with one central point, but ZigBee modules can also communicate with each other. This increases the range and allows them to take over each other's function. Each ZigBee module has a repeater that makes it possible to also return a signal. This could be handy when motion is detected and no one is at home. ZigBee can communicate with Hue, Alexa and Homey.

More information? Contact us for custom-made advice.

ZigBee is een communicatieprotocol wat slimme apparaten met elkaar in verbinding kan zetten. Een zogenoemd 'mesh' netwerk. ZigBee is slim, veilig en heeft een laag energieverbruik.

Het verschil met andere protocollen is, dat ZigBee niet alleen in contact staat met een centraal punt, maar ZigBee modules ook onderling met elkaar. Hierdoor wordt het bereik vergroot, en kunnen ze elkaars functie overnemen. Elke ZigBee module heeft een repeater waardoor een signaal ook terug gestuurd kan worden. Handig als er niemand thuis is, en er wordt bijvoorbeeld beweging gedetecteerd. ZigBee kan communiceren met o.a. Hue, Alexa en Homey.

Meer weten? Neem contact met ons op voor maatadvies sales@tronixlighting.com | +31 (0)413 33 03 80



ZIGBEE RECEIVER | 12-36V | 8A

Input voltage: 12 - 36V
IP rate: IP20
Connection type: Terminal block



ART. NR.	MAX. CURRENT	POWER OUTPUT	SIZE (L X H X W)
214-255	8000 mA	96W (12V) 192W (24V) 288W (36V)	95 x 37 x 20 mm

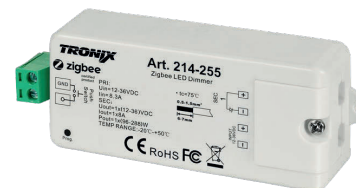

ZIGBEE RECEIVER | 12-48V | 20A

Suitable for 1-5 channels, RGB+TW/RGBW/RGB/TW.

Input voltage: 12 - 48V
IP rate: IP20
Connection type: Terminal block



ART. NR.	MAX. CURRENT	POWER OUTPUT	SIZE (L X W X H)
214-257	5 x 8000 mA (12V) 5 x 8000 mA (24V) 5 x 6000 mA (36V) 5 x 4000 mA (48V)	480W (12V) 960W (24V) 1080W (36V) 960W (48V)	170 x 59 x 29 mm



ZIGBEE RECEIVER | 100-240V PHASE-CUT DIM | RECESSED

Suitable for 86x86 mm wall boxes and can be operated with a standard/universal push button, a ZigBee remote control or a gateway as Homey.

Input voltage: 100 - 240V
IP rate: IP20
Connection type: Terminal block



ART. NR.	MAX. CURRENT	POWER OUTPUT	SIZE (L X W H X)
214-250	1800 mA	100W (110V) 200W (220V)	45,5 x 45 x 20,3 mm

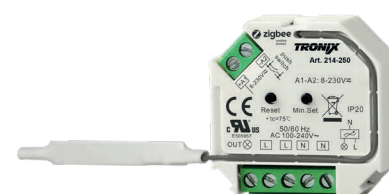

ZIGBEE | DOUBLE SWITCH | FRIENDS OF HUE

The switch can be configured via the Hue app and can both turn Hue lights on/off and dim (10-30m). Can be mounted directly on the wall with 3M adhesive tape,, or screws (included).

Battery: CR2430
IP rate: IP20
Connection type: n/a



ART. NR.	BUTTON	SIZE (L X W H)
214-270	4	80,5 x 80,5 x 14,7 mm

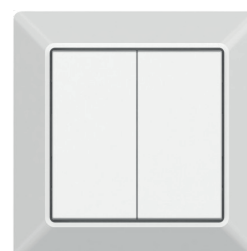

ZIGBEE | ROTARY SWITCH | RGB+TW/RGBW/RGB/TW/SC

This 4 in 1 dimmer can be configured via HUE or Homey app and controls up to 30 lamps. The rotary knob can dim, adjust light colors, and switching on/off. Can be mounted directly onto the wall with 3M, or screws (included).

Battery: 1x CR2450

IP rate: IP20



ART. NR.	ZONES	LENGTH	WIDTH	HEIGHT
214-271	1 (30 lamps)	80,5 mm	80,5 mm	29,2 mm

ZIGBEE | REMOTE CONTROL | SINGLE COLOR

Can control up to 4 groups at a distance up to 30 meters and can control up to 30 ZigBee devices.

Battery: 3x AAA (excluded)

IP rate: IP20



ART. NR.	ZONES	LENGTH	WIDTH	HEIGHT
214-277	4	120 mm	55 mm	17 mm

ZIGBEE | REMOTE CONTROL | TUNABLE WHITE

Can control up to 4 groups at a distance up to 30 meters and can control up to 30 ZigBee devices.

Battery: 3x AAA (excluded)

IP rate: IP20



ART. NR.	ZONES	LENGTH	WIDTH	HEIGHT
214-276	4	120 mm	55 mm	17 mm

ZIGBEE | REMOTE CONTROL | RGB+TW/RGBW/RGB

Can control up to 4 groups at a distance up to 30 meters and can control up to 30 ZigBee devices.

Battery: 3x AAA (excluded)

IP rate: IP20



ART. NR.	ZONES	LENGTH	WIDTH	HEIGHT
214-275	4	120 mm	55 mm	17 mm



White Panels with RGB Led Strips and Controllers Art.nr 214-143 and 214-157, Sushi corner Jumbo Cuijk - The Netherlands

Drivers & Controllers | Dimmers - Low Voltage

LED DIMMER 12-24V | 8A

To use between power supply and LED fixture.

Input voltage: 12 - 24V

IP Rate: IP20

Connection type: Terminal block



ART. NR.	MAXIMUM POWER	SIZE (L X W X H)
214-118	96 Watt (12V) 192 Watt (24V)	90 x 60 x 60 mm

LED DIMMER 12-24V | 25A

To use between power supply and LED fixture. Default = 2 KHz

Power: 0,5-2 KHz = 25A, 4/7,8 KHz = 15A, 15,6 KHz = 10A.

Input voltage: 12 - 24V

IP Rate: IP20

Connection type: Terminal block



ART. NR.	MAXIMUM POWER	SIZE (L X W X H)
214-123	300 Watt (12V) 600 Watt (24V)	103 x 40 x 42 mm

REMOTE CONTROL

PWM frequency 214-123 is adjustable by remote control. 6 levels: 500 Hz, 1 KHz, 2 KHz, 4 KHz, 7,8 KHz and 15,6 KHz.

ART. NR.	TYPE	SIZE (L X W X H)
214-090	Remote Control for 214-123	Ø 60 x 35 mm



Looking for our latest product releases? We keep continued focus on new product development and further extension of our range. Visit our website for a most actual overview.

Op zoek naar onze allernieuwste producten? We werken voortdurend aan nieuwe productontwikkeling en een verdere uitbreiding van ons assortiment. Bezoek onze website voor het meest actuele overzicht!



Accessories | Controllers & Sensors

BY PASS

Usable with a 2-wire dimmer or switch without a 0 (neutral) wire. The by pass ensures that LED's do not flicker and/or glow.

Input voltage: 100 - 240V

IP Rate: IP20

Connection type: Stripped wire



ART. NR.	POWER CONSUMPTION	MAXIMUM POWER	SIZE (L X W X H)
214-999	<1,4 Watt	N.A.	25 x 20 x 10 mm

MEANWELL | ICL-16L | AC LINEAR INRUSH CURRENT LIMITER

Can be used to reduce the high starting current due to load causing the circuit breaker to be false triggered.

Input voltage: 180 - 264V

IP Rate: IP20

Connection type: Terminal block



ICL-16L



ART. NR.	POWER CONSUMPTION	MAXIMUM POWER	SIZE (L X W X H)
214-950	<1,5 Watt	3680 Watt	90 x 35 x 58,4 mm

RGB DATA REPEATER | 3 CHANNELS | 12-24V

Input voltage: 12 - 24V

IP Rate: IP20

Connection type: Terminal block

Material: Aluminium

Color: Black



ART. NR.	MAX. CURRENT	POWER OUTPUT	SIZE (L X W H X)
214-128	3x 8 Ampère	3x 96-192W	91 x 90 x 24 mm

RGB DATA REPEATER | 4 CHANNELS | 12-36V

Input voltage: 12 - 36V

IP Rate: IP20

Connection type: Terminal block

Color: White



ART. NR.	MAX. CURRENT	POWER OUTPUT	SIZE (L X W H X)
214-127	4x 5 Ampère	4x 60-180W	178 x 45 x 19 mm

Drivers & Controllers | Controllers Single Color



ART. NR.
DIMMING
SIZE
BATTERY
RANGE
ZONES

214-173
Switch / Turn
96 x 65 x 74 mm
included
<20 meter
1



ART. NR. GREY
ART. NR. WHITE
DIMMING
SIZE
BATTERY
RANGE
ZONES

214-130
214-134
Push and hold
Ø32 mm x 10 mm
included
<20 meter
1



ART. NR.
DIMMING
SIZE
BATTERY
RANGE
ZONES

214-146
Touch Slide
35 x 141 x 8,5 mm
included
<20 meter
1



ART. NR.
DIMMING
SIZE
BATTERY
RANGE
ZONES

214-131
Push and hold
136,3 x 38,9 x 10,7 mm
included
<20 meter
5

Real glass



ART. NR.
DIMMING
SIZE
BATTERY
RANGE
ZONES
MATERIAL

214-144
Push and hold
86 x 86 x 13,8 mm
included
<20 meter
1
Real glass finishing

Real glass



ART. NR.
DIMMING
SIZE
BATTERY
RANGE
ZONES
MATERIAL

214-145
Switch / Turn
86 x 86 x 27 mm
included
<20 meter
1
Real glass finishing

Real glass



ART. NR.
DIMMING
SIZE
BATTERY
RANGE
ZONES
MATERIAL

214-152
RF wireless, push remote
86 x 86 x 13,8 mm
included
<20 meters
2
Real glass finishing

MAIN VOLTAGE:



CONSTANT VOLTAGE:



CONSTANT CURRENT:

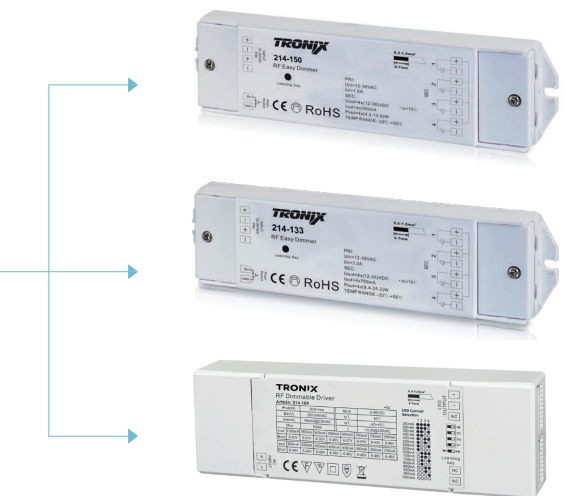

All above constant voltage and constant current controllers require a 12V or 24V power supply and can be controlled with a maximum of 8 remote controls.

Controllers Single Color | Drivers & Controllers

ART.NR	214-174
INPUT VOLT.	100 - 240V AC
MAX. CURRENT	1 x 0,68 Ampere
MAX. LOAD	1 x 100 Watt
SIZE	Ø46,5 x 19,5 mm
DIMMABLE	No

ART.NR	214-158
INPUT VOLT.	220 - 240V
MAX. CURRENT	1 x 0,45 Ampere
MAX. LOAD	1 x 100 Watt
SIZE	Ø46,5 x 19,5 mm
DIMMABLE	Yes

ART.NR	214-151
INPUT VOLT.	240V AC
MAX. CURRENT	2 x 1,2 Ampere
MAX. LOAD	2 x 288 Watt
SIZE	170 x 59 x 30 mm
DIMMABLE	Yes

To control constant main voltage dimmable LED application (for example LED GU10 lamps)



ART.NR	214-147
INPUT VOLT.	12-36 Volt
MAX. CURRENT	1 Channel x 8 Ampere max.
MAX. LOAD	96 Watt (12V) / 192 Watt (24V) / 288 Watt (36V)
SIZE	101 x 36 x 21 mm
DIMMABLE	Yes

ART.NR	214-132
INPUT VOLT.	12-36 Volt
MAX. CURRENT	4 Channels x 5 Ampere max.
MAX. LOAD	240 Watt (12 Volt) / 480 Watt (24 Volt)
SIZE	178 x 45 x 19 mm
DIMMABLE	Yes

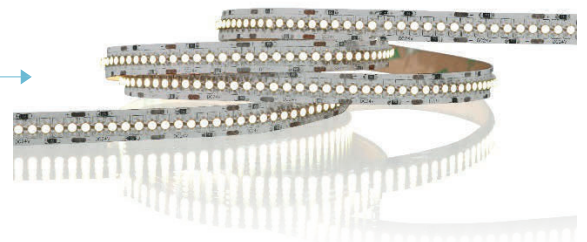

To control constant voltage LED applications (for example LED Strips 12V24V)

ART.NR	214-150
INPUT VOLT.	12-36 Volt
POWER	4 x 4,2 - 12,6W
MAX. LOAD	4 x 350mA x 12-36V
SIZE	178 x 45 x 19 mm
DIMMABLE	Yes

ART.NR	214-133
INPUT VOLT.	12-36 Volt
POWER	4 x 8,4 - 25,2W
MAX. LOAD	4 x 700mA x 12-36V
SIZE	178 x 45 x 19 mm
DIMMABLE	Yes

ART.NR	214-184
INPUT VOLT.	200-240 Volt
POWER	1 x 30W
OUTPUT CUR.	250-1000mA x 8-48V
SIZE	170 x 53,4 x 28 mm
DIMMABLE	Yes



To control constant current LED applications (for example Universal or Downlight modules 700mA)

Calculation example for Constant Voltage:

Based on the voltage of the Led strip and the amount of power coming from the LED strip (Watt p/m), you can determine the minimum required power quantity for your project and choose the right power supply.

Example: Based on a 24V LED Strip Art. nr. 127-128 and a project that requires 3,4 meters of this particular Led strip: Power consumption of the LED strip is 10 Watt p/m. Required power total is 3,4 meter x 10 Watt = 34 Watt

A good choice will be a 40W Power Supply Art. nr. 215-414

CV

Calculation example for Constant Current:

Based on the amperage/constant current of the fixture (usually 350mA or 700mA) and the correct current output, you can determine the minimum required power quantity for your project and choose the right power supply.

Example: Based on 3 pcs of Downlight modules Art. nr. 148-151 that need to be connected and powered: 350mA module with 3,3 Watt power. Required power total is 3 x 3,3 Watt = 9,9 Watt

A good choice will be a 350mA/20W Power Supply Art. nr. 215-412

CC

Drivers & Controllers | Controllers Multi Color



ART. NR.
REMOTE CONTROL
NR. OF ZONES
CHANGING PATTERNS
PATTERNS
SIZE

214-142
RGB+W Remote Control
2
4 built-in changing patterns
4 scenes can be saved
131,6 x 43,8 x 24,5 mm

ART. NR.
REMOTE CONTROL
NR. OF ZONES
CHANGING PATTERNS
PATTERNS
SIZE

214-157
RGB+W Remote Control
4
3 built-in changing patterns
3 scenes can be saved
120 x 55 x 17 mm

ART. NR.
REMOTE CONTROL
NR. OF ZONES
CHANGING PATTERNS
PATTERNS
SIZE

214-155
RGB+W Remote Control
8
10 built-in changing patterns
4 colors can be saved
131,6 x 43,8 x 24,5 mm

ART. NR. BLACK
ART. NR. WHITE
REMOTE CONTROL
NR. OF ZONES
CHANGING PATTERNS
PATTERNS
SIZE

214-168
214-169
RGB+W Remote Control
4
10 built-in changing
4 scenes can be saved
86 x 86 x 29,1 mm

ART. NR.
REMOTE CONTROL
NR. OF ZONES
CHANGING PATTERNS
PATTERNS
SIZE

214-175
Tunable white
4
3 built-in changing patterns
10 patterns can be saved
178 x 46 x 22 mm

ART. NR.
REMOTE CONTROL
NR. OF ZONES
TUNABLE
PATTERNS
SIZE

214-173
Single color
1
Light intensity
N/A
96 x 65 x 74 mm

ART. NR.
REMOTE CONTROL
NR. OF ZONES
TUNABLE
PATTERNS
SIZE

214-159
Tunable white
1
Light color & Light intensity
N/A
96 x 65 x 74 mm

ART. NR.
REMOTE CONTROL
NR. OF ZONES
TUNABLE
PATTERNS
SIZE

214-172
Tunable white
1
Light color & Light intensity
N/A
86 x 86 x 14 mm

ART. NR.
REMOTE CONTROL
NR. OF ZONES
CHANGING PATTERNS
PATTERNS
SIZE

214-178
RGB+Tunable white Control
4
4 built-in changing patterns
4 scenes can be saved
153 x 52 x 19 mm

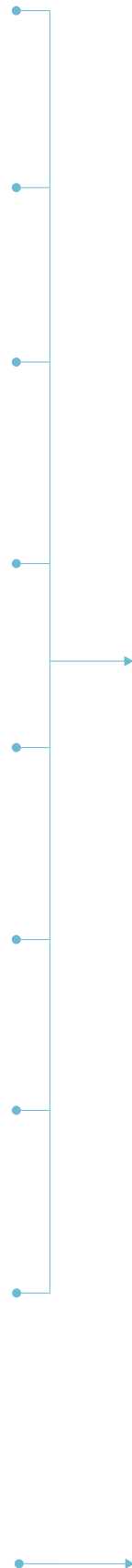

Controllers Multi Color | Drivers & Controllers

RGB+W CONTROLLER:

To control RGB+W LED applications. (for example RGB+W & Tunable white LED Strips and RGB+W LED Panels)



ART. NR.	214-143
INPUT VOLT.	12-36 Volt
MAX. CURRENT	4 x 5 Ampere
POWER	4 x 60 - 180W
IP RATE	IP20
SIZE	178 x 46 x 22 mm



DMX MASTER:

To control RGB+W LED applications. (Controllable DMX Fixtures, or Tunable white LED Strips or Tunable LED Panels with a DMX receiver)



ART. NR.	214-153
INPUT VOLT.	110 - 220V
OUTPUT	32 channels DMX / 8 zones
IP RATE	IP20
SIZE	178 x 57 x 21 mm



ART. NR.	214-166
INPUT VOLT.	12-36 Volt
MAX. CURRENT	5 x 5 Ampere
POWER	4 x 60 - 180W
IP RATE	IP20
SIZE	170 x 59 x 29 mm



To control RGB+TW LED applications. (For example LED Strips 127-085 or 127-086 RGB + Tunable white)



Drivers & Controllers | Controllers DMX

DMX RECEIVER | 4 CHANNELS * 8 AMPERE

Works with each DMX-master or with DMX wall panel Art. 214-135/214-139 or 214-182/214-183.

Input voltage: 12 - 36V
Dimmable: Yes
Remote control: No
Control method: DMX512

IP Rate: IP20
Connection type: Terminal block
Color: White

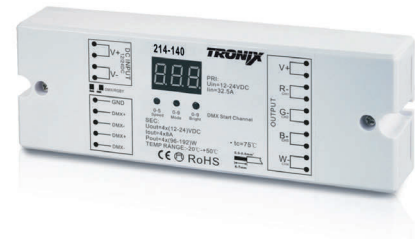

ART. NR.	MAX. CURRENT	POWER	SIZE (L X W X H)
214-140	4x 8000 mA	4x 96W (12V) 4x 192W (24V) 4x 288W (36V)	128 x 58 x 29 mm

DMX RECEIVER | 3/4 CHANNELS *6 AMPERE

Works with each DMX-master or with DMX wall panel Art. nr. 214-135/214-139 or 214-182/214-183.

Input voltage: 12 - 24V
Dimmable: Yes
Remote control: No
Control method: DMX512
IP Rate: IP20

Connection type: Terminal block / XLR / RJ45
Material: Aluminium
Color: Black



ART. NR.	MAX. CURRENT	POWER	SIZE (L X W X H)
214-113	3x 6000 mA	3x 72W (12V) 3x 144W (24V)	127 x 42 x 33 mm
214-115	4x 6000 mA	4x 72W (12V) 4x 144W (24V)	164 x 65 x 40 mm

DMX RECEIVER | 5 CHANNELS * 700mA

Works with each DMX-master or with DMX wall panel Art. nr. 214-135 or 214-139.

Input voltage: 12 - 36V
Dimmable: Yes
Remote control: No
Control method: DMX512
IP Rate: IP20

Connection type: Terminal block
Color: White



ART. NR.	MAX. CURRENT	POWER	SIZE (L X W X H)
214-141	5x 700 mA	5 x 8,4W (12V) 5 x 16,8W (24V) 5 x 25,2W (36V)	178 x 46 x 18 mm

DMX DIM MODULE | 2 CHANNELS | 100-240V PHASE-CUT

specifically designed to integrate Triac controllable lamps into DMX512 systems.

Input voltage: 100 - 240V
Output voltage: 100 - 240V
Dimmable: Yes
Remote control: No

Control method: DMX512
IP Rate: IP20
Connection type: Terminal block
Color: White



ART. NR.	MAX. CURRENT	POWER	SIZE (L X W X H)
214-181	2x 1200 mA	2x 120W (100V) 2x 288W (240V)	170 x 59 x 29 mm

Controllers DMX | Drivers & Controllers

DMX/DALI CONTROLLER | LINEARDRIVE

This constant voltage LED Driver is DMX compatible and allows you to create your color or dynamic show without an external controller.

Input voltage: 12 - 24V / 12 - 48V / 120 - 250V

IP rate: IP20

Connection type: Terminal block

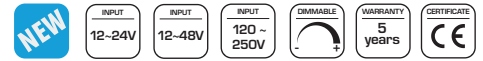

eldoLED® CV



ART. NR.	TYPE	INPUT VOLTAGE	MAX. CURRENT	POWER OUTPUT	ZONES	OUTPUTS	DIMMING	SIZE (L X W X H)
214-352	100/A	120 - 250V	4x 4000 mA	100 Watt	4	4	DMX/RDM/DALI	388 x 42 x 30 mm
214-353	180/D	12 - 24V	4x 6000 mA	180 Watt	4	4	DMX	153 x 50 x 23 mm
214-350	720/D	12 - 48V	4x 6000 mA	720 Watt	4	4	DMX/RDM/DALI	153 x 50 x 23 mm

LED DRIVER | POWERDRIVE | 50W | DMX

The POWERdrive 6060/R integrates 32 drivers into one, which can be controlled via DMX, DALI or 0-10V. You can install up to 32 fixtures (1-32 (DMX), 1-4 (DALI), 1 (0-10V) on the POWERdrive 6060/R, making this an extremely "clean", professional choice.

Input voltage: 120 - 230V

Power factor: >0,95

Dimmable: Dali/DMX/RDM/0-10V

IP Rate: IP20

Connection type: Terminal block

Isolation: SELV

Ambient temperature: -20°C / +50°C



eldoLED® CC



ART. NR.	TYPE	DALI TYPE	CONSTANT CURRENT	POWER	OUTPUT VOLTAGE	SIZE (L X W X H)
215-685	PW6060R1	DT6	200 ~ 1050 mA	600 Watt	2 - 55 Volt	482,6 x 325 x 44,5 mm

LED DRIVER | POWERDRIVE | DMX

The POWERdrive has a programmable, constant current output. It differs from the ECOdrive, SOLOdrive and DUALdrive in that it has four independent outputs. The POWERdrive is suitable for 50W (DMX, widely used in theatre technology).

Input voltage: 120 - 250V

Power factor: >0.95

Dimmable: DMX/RDM

IP Rate: IP20

Connection type: Terminal block

Isolation: SELV

Ambient temperature: -20°C / +50°C



eldoLED® CC



ART. NR.	TYPE	CONSTANT CURRENT	POWER	OUTPUT VOLTAGE	SIZE (L X W X H)
215-681	50SA-M420X	4x 150 ~ 1050 mA	50 Watt	2 - 55 Volt	153 x 76,2 x 30,5 mm

Drivers & Controllers | Controllers DMX

DMX WALL CONTROLLER | 1 ZONE

To use in combination with Art. nr. 214-113, 214-140 and 214-115.



Input voltage: 12 - 24V
Output: DMX512
Nr. of channels: 4 (DMX out)
IP Rate: IP20

Operation: Color wheel
Connection type: Terminal block
Size: 86 x 86 x 29,1 mm
Mounting: Wall panel



ART. NR.	COLOR
214-135	Black
214-139	White

DMX WALL CONTROLLER | 4 ZONES

To use in combination with Art. nr. 214-113, 214-140 and 214-115.

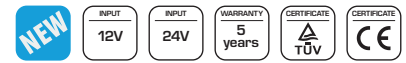

Input voltage: 12 - 24V
Output: DMX512
Nr. of channels: 16 (DMX out)
IP Rate: IP20

Operation: Color wheel
Connection type: Terminal block
Size: 86 x 86 x 29,1 mm
Mounting: Wall panel



ART. NR.	COLOR
214-182	Black
214-183	White

ART. NR.	ADVISED PRODUCTS
215-430	Power Supply 24V 9 Watt Small Type Indoor

DMX - MORE THAN THEATER AND EVENT TECHNOLOGY ALONE

- DMX is a universal and digital communication protocol used to control intelligent lighting equipment and special effects, and is therefore most commonly used in theater and event technology. But DMX has now also found its way to functional and utility construction, e.g. to highlight architectural buildings in a striking way.
- Ask us for the possibilities with DMX controlling or any other digital protocol for your project, we will be happy to assist you. sales@tronixlighting.com | +31 (0) 413 330 380.

DMX - MEER DAN ALLEEN THEATER EN EVENT TECHNOLOGIE

- DMX – Digital MultipleX - is een universeel en digitaal communicatieprotocol voor de aansturing van intelligente verlichtingsapparatuur en special effects, en wordt veelal toegepast in de theater- en evenemententechniek. Maar DMX heeft inmiddels ook haar weg gevonden naar de functionele- en utiliteitsbouw, waar het gebruikt wordt om architectonische gebouwen opvallend uit te lichten.
- Vraag ons naar de mogelijkheden met DMX of ander digitaal protocol voor uw project, we helpen u graag! sales@tronixlighting.com | +31 (0) 413330380.



RGB lighting controlled by DMX

Drivers & Controllers | Sensors

IR MOTION SENSOR | 360° | CEILING | IP20

Recessed infra-red motion sensor for suspended ceilings.

Input voltage: 220 - 240V
Time delay: 10 sec. - 7 min. (adj.)
Detection motion speed: 0,6 - 1,5 m/sec
Size: 55,4 x 25,5 x 36,8 mm (driver)

IP Rate: IP20
Connection type: Stripped wire



ART. NR.	DETECTION RADIUS	MAXIMUM LOAD	DETECTION DISTANCE	AMBIENT LIGHT
214-120	360°	200 Watt	Max. 8 meter	10-2000 Lux (adj.)

IR MOTION SENSOR | 180° | WALL | IP44

Infra-red motion sensor for wall mounting.

Input voltage: 220 - 240V
Time delay: 10 sec. - 7 min. (adj.)
Detection motion speed: 0,6 - 1,5 m/sec
Installation Height: 1,8 - 2,5m
Size: 80,2 x 55,5 x 68,2 mm

IP Rate: IP44
Connection type: Terminal block



ART. NR.	DETECTION RADIUS	MAXIMUM LOAD	DETECTION DISTANCE	AMBIENT LIGHT
214-119	180°	400 Watt	Max. 12 meter	3-2000 Lux (adj.)

IR MOTION SENSOR | 160° | WALL | IP20

Infra-red motion sensor for wall mounting, replaces light switch. Suitable for 2 or 3 wire connection (with or without N).

Input voltage: 220V - 240V
Time delay: 10 sec. - 7 min. (adj.)
Detection motion speed: 0,6 - 1,5 m/sec
Installation Height: 1 - 1,8m
Size: 80 x 80 x 33,1 mm

Mounting hole: 48 x 48 x 33,1
IP rate: IP20
Connection Type: Terminal block



ART. NR.	DETECTION RADIUS	MAXIMUM LOAD	DETECTION DISTANCE	AMBIENT LIGHT
214-050	160°	200 Watt	Max. 9 meter	3-2000 Lux (adj.)

IR MOTION SENSOR | CEILING | RECESSED | IP20

Recessed Infra-red motion sensor for suspended ceilings.

Input voltage: 220V - 240V
Time delay: 10 sec. - 15 min. (adj.)
Detection motion speed: 0,6 - 1,5 m/sec
Installation Height: 2,2 - 4m
Size: Ø76 mm (mounting size Ø61,5 x 75,6 mm)

IP rate: IP20
Connection type: Terminal block



ART. NR.	DETECTION RADIUS	MAXIMUM LOAD	DETECTION DISTANCE	AMBIENT LIGHT
214-051	360°	300 Watt	Max. 6 meter	3-2000 Lux (adj.)

Sensors | Controllers & Sensors

IR MOTION SENSOR | 360° | CEILING | SURFACE | IP20

Surface mounted infra-red motion sensor for ceilings.



Input voltage: 220 - 240V
Time delay: 10 sec. - 15 min. (adj.)
Detection motion speed: 0,6 - 1,5 m/sec
Installation Height: 2,2 - 4m
Size: Ø80 x 41 mm

IP rate: IP20
Connection type: Terminal block



ART. NR.	DETECTION RADIUS	MAXIMUM LOAD	DETECTION DISTANCE	AMBIENT LIGHT
214-052	360°	600 Watt	Max. 6 meter	3-2000 Lux (adj.)

DAY/NIGHT SENSOR | WALL | TIMER | IP54

Day/night sensor for outdoor installation (IP54).



Input voltage: 220 - 240V
Time delay: 1 to 9 hours. (adj.)
Detection motion speed: n/a
Installation Height: n/a
Size: 108,8 x 70 mm

IP rate: IP54
Connection type: Terminal block



ART. NR.	MAXIMUM LOAD	AMBIENT LIGHT
214-060	1150 Watt	3-500 Lux (adj.)

DAY/NIGHT SENSOR | WALL | IP44

Day/night sensor for installation in damp areas, or outside (IP44).



Input voltage: 220 - 240V
Time delay: Switches on at 2 Lux (adj.) and off at 100 Lux
Detection motion speed: n/a
Installation Height: n/a
Size: 96,2 x 65,4 mm

IP rate: IP44
Connection type: Terminal block



ART. NR.	MAXIMUM LOAD	AMBIENT LIGHT
214-061	1500 Watt	2-100 Lux

CASAMBI SENSOR | MOTION + LIGHT BLACK & WHITE

Input voltage: 220 - 240V
IP rate: IP44 (front)
Size: 73 x Ø38 (Ø25 mm mounting hole)
Connection type: Stripped wire



CASAMBI

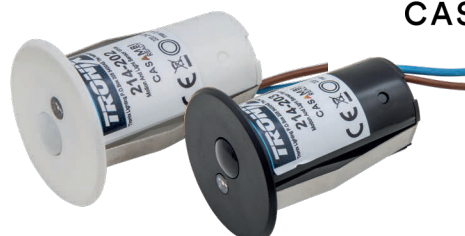

ART. NR.	HOUSING COLOR	MAX. LOAD	DETEC. RADIUS	DETEC. RANGE	MOUNTING HEIGHT
214-202	○ White	64 zones	100°	max. 7 meter	3 meter
214-203	● Black	64 zones	100°	max. 7 meter	3 meter

Drivers & Controllers | Sensors

IR HAND WAVE SENSOR | 12-36V | IP20 LONG/SHORT SHELL

For switching on/off (short hand-wave) or dimming (long hand-wave).

Input voltage: 12 - 36V

Time delay: N/A

Detection motion speed: N/A

Size: 95 x 37 x 20 mm (driver)

IP Rate: IP20

Connection type: Screw terminal

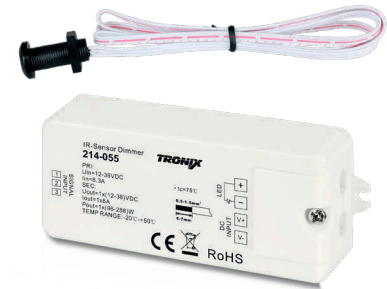

214-055
Short Shell

214-056
Long Shell

ART. NR.	TYPE	SIZE SHELL	MAXIMUM LOAD	DETECTION DISTANCE
214-055	Long shell	Ø 17 mm (sensor) Ø 11 mm x 25 mm (screw)	96-288 Watt	Max. 6 cm (hand wave)
214-056	Short shell	Ø 20 mm (sensor) Ø 17 mm x 17 mm (screw)	96-288 Watt	Max. 6 cm (hand wave)

IR DOOR SENSOR | BLACK/WHITE | 12-24V 2A | IP20

For switching on/off (short touch) or dimming (long touch).

Input voltage: 12 - 24V

Time delay: N/A

Detection motion speed: N/A

Size: 95 x 37 x 20 mm (driver)

IP Rate: IP20

Connection type: Screw terminal



ART. NR.	COLOR	MAXIMUM LOAD	DETECTION DISTANCE
214-057	Black	96-288 Watt	Touch
214-058	White	96-288 Watt	Touch



Looking for our latest product releases? We keep continued focus on new product development and further extension of our range. Visit our website for a most actual overview.

Op zoek naar onze allernieuwste producten? We werken voortdurend aan nieuwe productontwikkeling en een verdere uitbreiding van ons assortiment. Bezoek onze website voor het meest actuele overzicht!



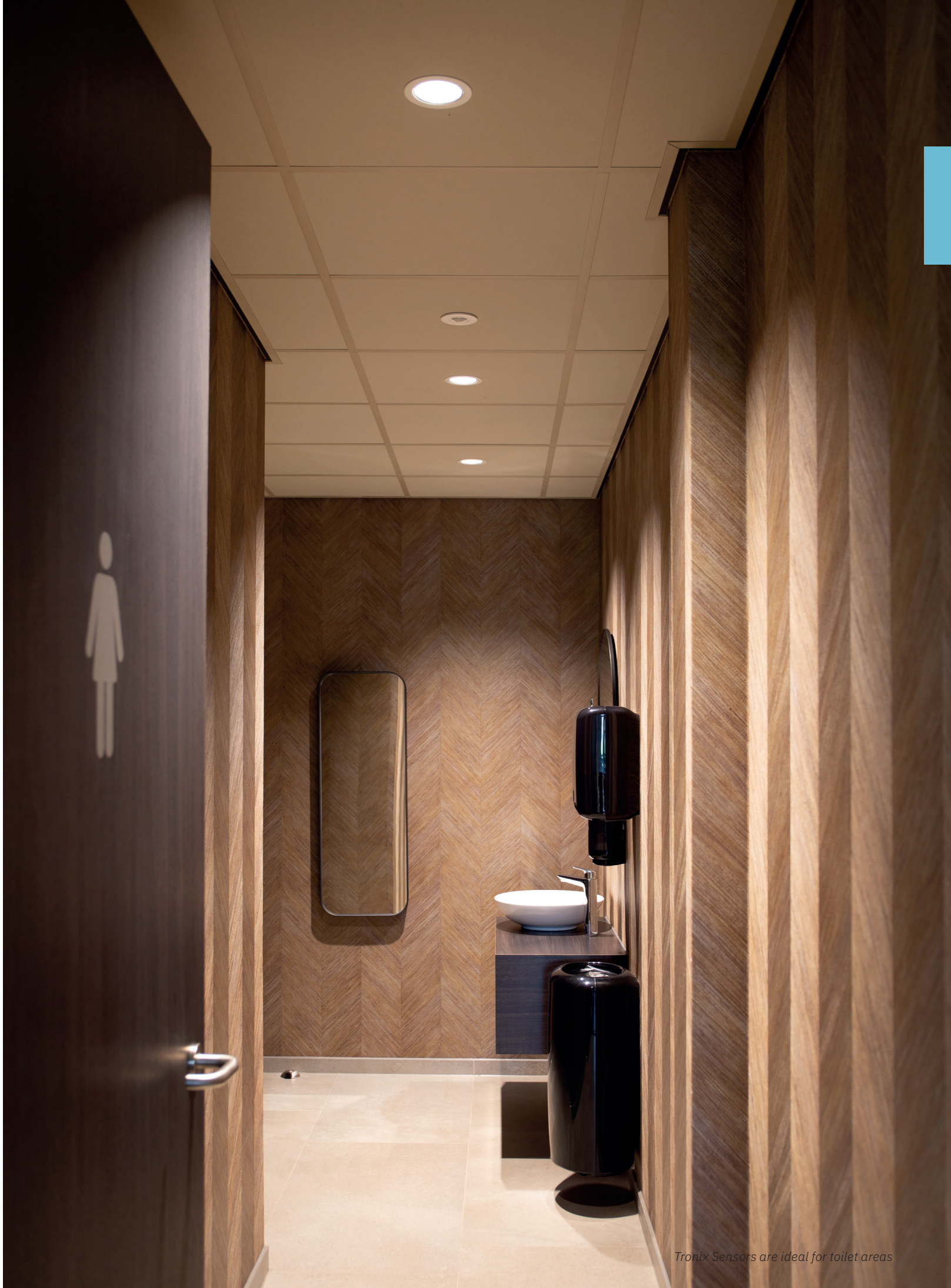

Tronix Sensors are ideal for toilet areas

2 LED Strips

A wide range of flexible light strips and
to suit any decorative lighting application





LED Strips | Single Color

LED STRIPS | 60 LED/M | SINGLE COLOR

SMD3528 | 60 LED/M Led Strips with one fixed light color, for indoor and outdoor use.



3M



ART. NR.	IP	12V	COLOR	WATT/M	LUMEN/M	LUMEN/W	CRI	R9	✂	LENGTH	SIZE (W X H)
127-043	IP20	12V	2700K	4,8	278	57,9	>90	82	50 mm	5 meters	8 x 2 mm
127-008	IP20	12V	3000K	4,8	288	60,0	>90	85,8	50 mm	5 meters	8 x 2 mm
127-044	IP20	12V	4000K	4,8	299	62,4	>90	90,4	50 mm	5 meters	8 x 2 mm
127-001	IP20	12V	6500K	4,8	309	64,3	>90	83,6	50 mm	5 meters	8 x 2 mm
127-002	IP20	12V	Blue	4,8	n.a.	n.a.	n.a.	n.a.	50 mm	5 meters	8 x 2 mm
127-003	IP20	12V	Green	4,8	n.a.	n.a.	n.a.	n.a.	50 mm	5 meters	8 x 2 mm
127-004	IP20	12V	Red	4,8	n.a.	n.a.	n.a.	n.a.	50 mm	5 meters	8 x 2 mm
127-005	IP20	12V	Amber	4,8	n.a.	n.a.	n.a.	n.a.	50 mm	5 meters	8 x 2 mm
127-039	IP65	12V	3000K	4,8	288	60,0	>90	85,8	50 mm	5 meters	10 x 4 mm

ART. NR.	IP	24V	COLOR	WATT/M	LUMEN/M	LUMEN/W	CRI	R9	✂	LENGTH	SIZE (W X H)
127-014	IP20	24V	2700K	4,8	278	57,9	>90	82	100 mm	5 meters	8 x 2 mm
127-013	IP20	24V	3000K	4,8	288	60,0	>90	85,8	100 mm	5 meters	8 x 2 mm
127-082	IP67	24V	2700K	4,8	278	57,9	>90	82	100 mm	5 meters	10 x 4 mm
127-078	IP67	24V	3000K	4,8	288	60,0	>90	85,8	100 mm	5 meters	10 x 4 mm

LED STRIPS | 120 LED/M | SINGLE COLOR

SMD3528 | 120 LED/M Led Strips with one fixed light color, for indoor and outdoor use.



3M



ART. NR.	IP	VOLTAGE	COLOR	WATT/M	LUMEN/M	LUMEN/W	CRI	R9	✂	LENGTH	SIZE (W X H)
127-049	IP20	24V	2100K	9,6	591	61,5	>90	81,8	50 mm	5 meters	8 x 2 mm
127-060	IP20	24V	2700K	9,6	610	63,6	>90	82,8	50 mm	5 meters	8 x 2 mm
127-065	IP20	24V	3000K	9,6	626	65,2	>90	83,3	50 mm	5 meters	8 x 2 mm
127-066	IP20	24V	4000K	9,6	637	66,4	>90	83,9	50 mm	5 meters	8 x 2 mm
127-067	IP20	24V	7000K	9,6	649	67,6	>90	81,6	50 mm	5 meters	8 x 2 mm
127-042	IP20	24V	Blue	9,6	n.a.	n.a.	n.a.	n.a.	50 mm	5 meters	8 x 2 mm
127-046	IP20	24V	Pink	9,6	n.a.	n.a.	n.a.	n.a.	50 mm	5 meters	8 x 2 mm
127-059	IP52	24V	2700K	9,6	610	63,6	>90	82,8	50 mm	5 meters	8 x 2,3 mm
127-058	IP52	24V	3000K	9,6	626	65,2	>90	83,3	50 mm	5 meters	8 x 2,3 mm
127-057	IP52	24V	4000K	9,6	637	66,4	>90	83,9	50 mm	5 meters	8 x 2,3 mm
127-041	IP52	24V	6500K	9,6	649	67,6	>90	81,6	50 mm	5 meters	8 x 2,3 mm
127-119	IP65	24V	2700K	9,6	610	63,6	>90	82,8	50 mm	5 meters	8,2 x 2,2 mm
127-118	IP65	24V	3000K	9,6	626	65,2	>90	83,3	50 mm	5 meters	8,2 x 2,2 mm
127-089	IP67	24V	2700K	9,6	610	63,6	>90	82,8	50 mm	5 meters	10 x 4 mm
127-088	IP67	24V	3000K	9,6	626	65,2	>90	83,3	50 mm	5 meters	10 x 4 mm

LED STRIPS | 120 LED/M | SINGLE COLOR

SMD1808 | 120 LED/M Led Strips with one fixed light color, for indoor use.



3M



ART. NR.	IP	VOLTAGE	COLOR	WATT/M	LUMEN/M	LUMEN/W	CRI	R9	✂	LENGTH	SIZE (W X H)
127-173	IP20	24V	2700K	9,6	773	80,5	>95	93,4	25 mm	5 meters	8 x 1,4 mm
127-172	IP20	24V	3000K	9,6	896	93,3	>95	95,9	25 mm	5 meters	8 x 1,4 mm
127-171	IP20	24V	4000K	9,6	914	96,3	>95	95,2	25 mm	5 meters	8 x 1,4 mm

Single Color | LED Strips

LED STRIPS | 180 LED/M

SMD3528 | 180 LED/M Led Strips with one fixed light color, for indoor and outdoor use.



3M



ART. NR.	IP	VOLTAGE	COLOR	WATT/M	LUMEN/M	LUMEN/W	CRI	R9	∅	LENGTH	SIZE (W X H)
127-094	IP20	24V	● 2700K	14,4	883	61,3	>90	81,8	33 mm	5 meters	10 x 2 mm
127-093	IP20	24V	○ 3000K	14,4	901	62,6	>90	82,8	33 mm	5 meters	10 x 2 mm
127-092	IP20	24V	○ 4000K	14,4	915	63,6	>90	82,2	33 mm	5 meters	10 x 2 mm
127-096	IP65	24V	● 2700K	14,4	883	61,3	>90	81,8	33 mm	5 meters	10,2 x 2,2 mm
127-095	IP65	24V	○ 3000K	14,4	901	62,6	>90	82,8	33 mm	5 meters	10,2 x 2,2 mm

LED STRIPS | 240 LED/M

SMD3528 | 240 LED/M Led Strips with one fixed light color, for indoor use.



3M

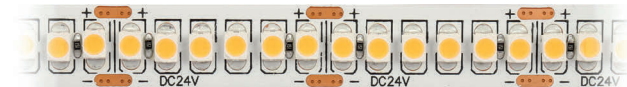

ART. NR.	IP	VOLTAGE	COLOR	WATT/M	LUMEN/M	LUMEN/W	CRI	R9	∅	LENGTH	SIZE (W X H)
127-069	IP20	24V	● 2700K	19,2	1159	60,4	>90	82,2	25 mm	5 meters	10 x 2 mm
127-116	IP20	24V	○ 3000K	19,2	1192	62,1	>90	83,4	25 mm	5 meters	10 x 2 mm
127-073	IP20	24V	○ 4000K	19,2	1200	62,5	>90	83,4	25 mm	5 meters	10 x 2 mm
127-074	IP20	24V	○ 7000K	19,2	1221	63,6	>90	80,6	25 mm	5 meters	10 x 2 mm

LED STRIPS | 240 LED/M

SMD1808 | 240 LED/M Led Strips with one fixed light color, for indoor use.



3M



ART. NR.	IP	VOLTAGE	COLOR	WATT/M	LUMEN/M	LUMEN/W	CRI	R9	∅	LENGTH	SIZE (W X H)
127-183	IP20	24V	● 2700K	19,2	1524	79,4	>95	94,6	25 mm	5 meters	10 x 1,4 mm
127-182	IP20	24V	○ 3000K	19,2	1770	92,2	>95	95,9	25 mm	5 meters	10 x 1,4 mm
127-181	IP20	24V	○ 4000K	19,2	1806	94,1	>95	96,9	25 mm	5 meters	10 x 1,4 mm

LED STRIPS 560 LED/M

SMD1808 | 560 LED/M Led Strips with one fixed light color, for indoor use.



3M



ART. NR.	IP	VOLTAGE	COLOR	WATT/M	LUMEN/M	LUMEN/W	CRI	R9	∅	LENGTH	SIZE (W X H)
127-194	IP20	24V	● 2300K	20	1802	90,8	>95	90,3	12,5 mm	5 meters	10 x 1,4 mm
127-193	IP20	24V	○ 2700K	20	1850	92,5	>95	93,4	12,5 mm	5 meters	10 x 1,4 mm
127-192	IP20	24V	○ 3000K	20	2118	105,9	>95	96,6	12,5 mm	5 meters	10 x 1,4 mm
127-191	IP20	24V	○ 4000K	20	2202	110,1	>95	96,6	12,5 mm	5 meters	10 x 1,4 mm
127-190	IP20	24V	○ 6000K	20	2296	114,8	>95	90,9	12,5 mm	5 meters	10 x 1,4 mm
127-198	IP65	24V	● 2300K	20	1802	90,8	>95	90,3	12,5 mm	5 meters	10 x 1,4 mm
127-197	IP65	24V	○ 2700K	20	1850	92,5	>95	93,4	12,5 mm	5 meters	10 x 1,4 mm
127-196	IP65	24V	○ 3000K	20	2118	105,9	>95	96,6	12,5 mm	5 meters	10 x 1,4 mm
127-195	IP65	24V	○ 4000K	20	2202	110,1	>95	96,6	12,5 mm	5 meters	10 x 1,4 mm

LED Strips | Multi Color

ADJUSTABLE WHITE / FLAME DIMMING 2700K~6000K / 1800K-3000K

SMD3825 | SMD3014 | SMD2216 | Dual color Led strips with adjustable color temperature from 2700K-6000K, or flame dimming 1800K-3000K.



ART. NR.	IP	VOLTAGE	COLOR	ADJ. / FLAME	LED/M	WATT/M	LUMEN/M	LUMEN/W	CRI	∅	LENGTH	SIZE (W X H)
127-063	IP20	12V	2700-6000K	Adj. white	120	9,6	676	70,4	>90	50 mm	5 meters	10 x 2 mm
127-138	IP20	24V	1800-3000K	Flame dim.	224	18	1389	77,2	>90	62,5 mm	5 meters	10 x 1,2 mm
127-083	IP20	24V	2700-6000K	Adj. white	224	23,0	2407	104,6	>90	62,5 mm	5 meters	10 x 1,2 mm

RGB

SMD5050 LED | RGB Led strips for indoor and outdoor use.



ART. NR.	IP	VOLTAGE	COLOR (CCT) 100%RGB	LED/M	WATT/M	LUMEN/M	LUMEN/W	CRI	∅	LENGTH	SIZE (W X H)
127-000	IP20	12V	42.300	30	7,2	310	44,0	50	100 mm	5 meters	10 x 2 mm
127-102	IP20	12V	42.300	60	14,4	620	43,1	50	50 mm	5 meters	8 x 2 mm
127-101	IP20	24V	42.300	60	14,4	620	43,1	50	100 mm	5 meters	10 x 2 mm
127-104	IP20	24V	42.300	96	23,0	980	44,0	50	62,5 mm	5 meters	12 x 2 mm
127-010	IP52	24V	42.300	60	14,4	620	43,1	50	100 mm	5 meters	10 x 2,3 mm
127-106	IP65	24V	42.300	96	23,0	980	44,0	50	62,5 mm	5 meters	12,2 x 2,2 mm
127-070	IP67	24V	42.300	60	14,4	620	43,1	50	100 mm	5 meters	12 x 4 mm

RGB + WARM WHITE

SMD5050 LED | RGB + Warm white (4 in 1 led) Led strip for indoor and outdoor use



ART. NR.	IP	VOLTAGE	COLOR (CCT) 100%RGB	CCT WHITE	LED/M	WATT/M	LUMEN/M	LUMEN/W	CRI	∅	LENGTH	SIZE (W X H)
127-075	IP20	24V	42.300	2700K	60	19,2	1113	58	55,4	100 mm	5 meters	12 x 2 mm
127-079	IP20	24V	42.300	2700K	96	30,6	1650	57	57,0	62,5 mm	5 meters	12 x 2 mm
127-084	IP65	24V	42.300	2700K	60	19,2	1113	58	55,4	100 mm	5 meters	12,2 x 2,2 mm

CONTROLLERS FOR ADJUSTABLE WHITE LED STRIPS

Art. nr. 214-159
DIMMING Switch / Turn
SIZE 96 x 65 x 74 mm
BATTERY included
RANGE <20 meter
ZONES 1



Art. nr. 214-172
DIMMING Push remote
SIZE 86 x 86 x 14 mm
BATTERY included
RANGE <20 meter
ZONES 1



Art. nr. 214-175
DIMMING Color wheel
SIZE 120 x 55 x 17 mm
BATTERY included
RANGE <20 meter
ZONES 4



Art. nr. 214-143
SIZE 178 x 46 x 22 mm
INPUT 12-36V
POWER 4 x 60-180W
ZONES 1
CHANNELS 4



Multi Color | LED Strips

RGB + TUNABLE WHITE (5 IN 1)

SMD5050 LED | RGB + Tunable white (5 in 1 led) Led strip for indoor and outdoor use



ART. NR.	IP	VOLTAGE	COLOR (CCT) 100%RGB	CCT WHITE	LED/M	WATT/M	LUMEN/M	LUMEN/W	CRI	✂	LENGTH	SIZE (W X H)
127-085	IP20	24V	42.300	2400K~6000K	60	19,2	1101	57	83,24	100 mm	5 meters	12 x 2 mm
127-086	IP52	24V	42.300	2400K~6000K	60	19,2	1101	57	83,24	100 mm	5 meters	12 x 2,3 mm

CONTROLLERS FOR ADJUSTABLE LED STRIP 127-085 / 127-086

Art. nr.	214-178
DIMMING	Color wheel
SIZE	153 x 52 x 19 mm
BATTERY	excluded
RANGE	<20 meter
ZONES	4



Art. nr.	214-166
SIZE	170x 59 x 29 mm
INPUT	12-36V
POWER	5 x 60-180W
ZONES	1
CHANNELS	5



Looking for our latest product releases? We keep continued focus on new product development and further extension of our range. Visit our website for a most actual overview.

Op zoek naar onze allernieuwste producten? We werken voortdurend aan nieuwe productontwikkeling en een verdere uitbreiding van ons assortiment. Bezoek onze website voor het meest actuele overzicht!

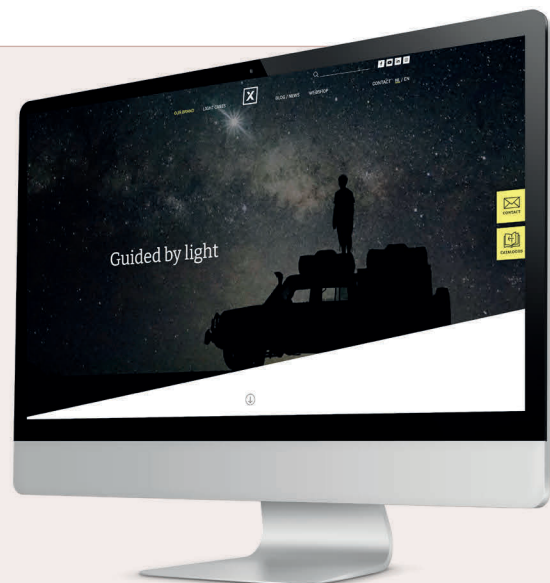

LED Strips | Constant Current

LED STRIPS | CONSTANT CURRENT SINGLE COLOR



SMD 2835 | Single color Led strip for indoor use. For lengths up to 20 meter with a special technology for an equal distribution of light output.



ART. NR.	IP	VOLTAGE	COLOR	LED/M	WATT/M	LUMEN/M	LUMEN/W	CRI	R9	✂	LENGTH	SIZE (W X H)
127-117	IP20	24V	2700K	120	24	2098	87,4	91,3	78,9	50 mm	5 meters	10 x 1,2mm
127-112	IP20	24V	2700K	60	8,5	751	88,4	90,3	78,8	100 mm	20 meters	12 x 1,2mm
127-111	IP20	24V	3000K	60	8,5	780	91,8	92,4	84,8	100 mm	20 meters	12 x 1,2mm

LED STRIP | CONSTANT CURRENT ADJUSTABLE WHITE



SMD 2835 | Single color Led strip for indoor use. For lengths up to 15 meter with a special technology for an equal distribution of light output.



ART. NR.	IP	VOLTAGE	COLOR	LED/M	WATT/M	LUMEN/M	LUMEN/W	CRI	R9	✂	LENGTH	SIZE (W X H)
127-113	IP20	24V	2400-6000K	120	12	600 Lm (2400K) 604 Lm (6000K)	70,4	92,8	n.a.	50 mm	15 meters	12 x 1,2 mm

LED STRIP | CONSTANT CURRENT | RGB



SMD 5050 | Dual color Led strip for indoor use. For lengths up to 15 meter with a special technology for an equal distribution of light output.

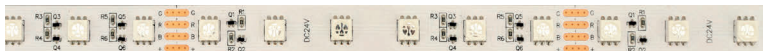

ART. NR.	IP	VOLTAGE	COLOR (CCT) 100%RGB	LED/M	WATT/M	LUMEN/M	LUMEN/W	CRI	R9	✂	LENGTH	SIZE (W X H)
127-114	IP20	24V	30.000	60	11	550	50	50	n.a.	100 mm	15 meters	12 x 2 mm

LED STRIP | CONSTANT CURRENT RGB + WARM WHITE



SMD 5050 | RGB + warm white (4 in 1 Led) Led strip for indoor use. For lengths up to 15 meter with a special technology for an equal distribution of light output.



ART. NR.	IP	VOLTAGE	COLOR (CCT) 100%RGB	CCT WHITE	LED/M	WATT/M	LUMEN/M	LUMEN/W	CRI	✂	LENGTH	SIZE (W X H)
127-115	IP20	24V	30.000	2700K	60	11	730,2	66,4	n.a.	100 mm	15 meters	12 x 2mm



Tronix Led Strips Single Color and RGB at food store Pincho Copa, Uden - The Netherlands

LED Strips | COB

LED STRIPS COB | SINGLE COLOR | WHITE

COB LED | For applications in shallow (undeep) profiles, for maximum light spread (no dots).



3M



ART. NR.	IP	VOLT.	COLOR	LED/M	WATT/M	LUMEN/M	LUMEN/W	CRI	R9	✂	LENGTH	SIZE. (W X H)
127-163	IP20	24V	2700K	480	15	1418	94,53	>90	55,8	50 mm	5 meters	8 x 2 mm
127-162	IP20	24V	3000K	480	15	1527	101,8	>90	67,5	50 mm	5 meters	8 x 2 mm
127-161	IP20	24V	4000K	480	15	1690	112,7	>90	69,9	50 mm	5 meters	8 x 2 mm
127-160	IP20	24V	6500K	480	15	1672	111,5	>90	69,1	50 mm	5 meters	8 x 2 mm

LED STRIPS COB | SINGLE COLOR | WHITE

COB LED | For applications in shallow (undeep) profiles, for maximum light spread (no dots).



3M



ART. NR.	IP	VOLT.	COLOR	LED/M	WATT/M	LUMEN/M	LUMEN/W	CRI	R9	✂	LENGTH	SIZE. (W X H)
127-035	IP20	24V	3000K	384	10	1000	100,0	>90	71,9	41,66 mm	5 meters	8 x 2 mm
127-034	IP20	24V	4000K	384	10	1000	100,0	>90	73,6	41,66 mm	5 meters	8 x 2 mm
127-033	IP20	24V	6000K	384	10	1000	100,0	>90	63,4	41,66 mm	5 meters	8 x 2 mm

LED STRIPS COB | SINGLE COLOR | WHITE

COB LED | For applications in shallow (undeep) profiles, for maximum light spread (no dots).



3M



ART. NR.	IP	VOLT.	COLOR	LED/M	WATT/M	LUMEN/M	LUMEN/W	CRI	R9	✂	LENGTH	SIZE. (W X H)
127-158	IP20	24V	2700K	480	5	480	96,2	>90	55,8	50 mm	5 meters	4 x 2 mm
127-157	IP20	24V	3000K	480	5	512	102,4	>90	67,5	50 mm	5 meters	4 x 2 mm
127-156	IP20	24V	4000K	480	5	550	110,0	>90	69,9	50 mm	5 meters	4 x 2 mm
127-155	IP20	24V	6500K	480	5	573	114,6	>90	69,1	50 mm	5 meters	4 x 2 mm

LED STRIPS COB | SINGLE COLOR | COLOR

COB LED | For applications in shallow (undeep) profiles, for maximum light spread (no dots).



3M



ART. NR.	IP	VOLT.	COLOR	LED/M	WATT/M	LUMEN/M	LUMEN/W	CRI	R9	✂	LENGTH	SIZE. (W X H)
127-121	IP20	24V	Blue	512	10	199,8	19,98	n/a	n/a	62,5 mm	5 meters	8 x 2 mm
127-122	IP20	24V	Green	512	10	1289,9	128,99	n/a	n/a	62,5 mm	5 meters	8 x 2 mm
127-123	IP20	24V	Red	512	10	179,7	17,97	n/a	n/a	62,5 mm	5 meters	8 x 2 mm
127-124	IP20	24V	Yellow	512	10	803,3	80,33	n/a	n/a	62,5 mm	5 meters	8 x 2 mm

COB | LED Strips

LED STRIP COB | ADJUSTABLE WHITE 2700~6000K

COB LED | For applications in shallow (undeeep) profiles, for maximum light spread (no dots).



ART. NR.	IP	VOLT.	COLOR	LED/M	WATT/M	LUMEN/M	LUMEN/W	CRI	R9	✂	LENGTH	SIZE. (W X H)
127-129	IP20	24V	●○ 2700-6000K	576	15	1525	101,7	>90	2700K 76,83 6000K 95,85		5 meters	10 x 2 mm

LED STRIP COB | RGB

COB LED | For applications in shallow (undeeep) profiles, for maximum light spread (no dots).



ART. NR.	IP	VOLT.	COLOR (CCT) 100% RGB	LED/M	WATT/M	LUMEN/M	LUMEN/W	CRI	R9	✂	LENGTH	SIZE. (W X H)
127-133	IP20	24V	● 42.300	1134	15	645	43,0	n/a	n/a		5 meters	12 x 2 mm



i

COB LED Strips: no visible light dots

These led strips are using the COB (Chip On Board) technology, where chips are placed very closely together. Biggest advantage: no visible 'light dots' and a very uniform light spread. This makes COB Led strips ideal for use in shallow (undeeep) profiles. For maximum light spread, please use in combination with frosted or opal cover. *Check our website for the Galaxy profile catalog.

LED Strips | Specials

LED STRIPS | MINI CUT

SMD 2835 | Led strip with a high light output and extra short cutting length. Cuttable per Led, so very flexible.



ART. NR.	IP	VOLT.	COLOR	LED/M	WATT/M	LUMEN/M	LUMEN/W	CRI	R9	✂	LENGTH	SIZE. (W X H)
127-132	IP20	24V	● 2700K	120	19	1461	76,9	>90	76,9	8,3 mm	5 meter	10 x 1,2 mm
127-131	IP20	24V	○ 3000K	120	19	1527	80,4	>90	80,0	8,3 mm	5 meter	10 x 1,2 mm
127-130	IP20	24V	○ 6000K	120	19	1575	82,9	>90	77,9	8,3 mm	5 meter	10 x 1,2 mm

LED STRIP | HIGH EFFICIENCY

SMD 2835 | Led strip with an extra high light efficiency of 160 Lm/W.



ART. NR.	IP	VOLT.	COLOR	LED/M	WATT/M	LUMEN/M	LUMEN/W	CRI	R9	✂	LENGTH	SIZE. (W X H)
127-140	IP20	24V	○ 3000K	160	21	3368	160,4	78,22	0,9	50 mm	5 meter	12 x 1,2 mm

LED STRIP HIGH LUMEN

SMD 5630 | Led strip with Samsung Led for an extra high light output.



ART. NR.	IP	VOLT.	COLOR	LED/M	WATT/M	LUMEN/M	LUMEN/W	CRI	R9	✂	LENGTH	SIZE. (W X H)
127-090	IP20	24V	● 2700K	2x 60	28,8	2358	81,88	>90	68,9	50 mm	5 meters	15 x 1,2 mm



Installing LED Strips: Our advice

When installing Led strips, we advice you to place them only in our high quality range of aluminium Galaxy Profiles. These profiles will not only protect the Led strips from grease and dust, but also have an important cooling function that prevents the Led's from getting too hot.

Specials | LED Strips

LED STRIPS | SIDE EMITTING (SINGLE COLOR)

SMD3014 | Led strip with the light output coming from the side, ideal for making curves or full circles while maintaining maximum light output.

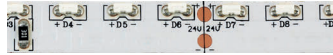

ART. NR.	IP	VOLT.	COLOR	LED/M	WATT/M	LUMEN/M	LUMEN/W	CRI	R9	∅<	LENGTH	SIZE. (W X H)
127-062	IP20	24V	● 2700K	120	12	907	75,6	>80	2,6	50 mm	5 meters	8 x 2 mm
127-077	IP20	24V	○ 6000K	120	12	1042	86,8	>80	20,0	50 mm	5 meters	8 x 2 mm

LED STRIPS | BENDABLE (SINGLE COLOR OR RGB)

Bendable Led strips of special PCB material to easy make curves or any other desired shapes.



ART. NR.	IP	VOLT.	COLOR	LED/M	WATT/M	LUMEN/M	LUMEN/W	CRI	R9	∅<	LENGTH	SIZE. (W X H)
127-080	IP20	12V	● 3000K	60	12	1073	89,4	>90	84,9	50 mm	5 meters	8 x 1,2 mm
127-081	IP20	12V	● RGB	42	10	500	44	n.a.	n.a.	71,4 mm	5 meters	12 x 2 mm

LED STRIPS | ULTRA NARROW | 3 MM

Extra narrow Led strip for use in narrow profiles and applications require this.



ART. NR.	IP	VOLT.	COLOR	LED/M	WATT/M	LUMEN/M	LUMEN/W	CRI	R9	∅<	LENGTH	SIZE. (W X H)
127-152	IP20	24V	● 2700K	240	8	601	75,2	>95	88,6	25 mm	5 meters	3 x 1,4 mm
127-151	IP20	24V	● 3000K	240	8	742	92,8	>95	96,3	25 mm	5 meters	3 x 1,4 mm
127-150	IP20	24V	○ 4000K	240	8	803	100,4	>95	96,8	25 mm	5 meters	3 x 1,4 mm

LED STRIPS | ULTRA NARROW | 5 MM

Extra narrow Led strip for use in narrow profiles and applications require this.



ART. NR.	IP	VOLT.	COLOR	LED/M	WATT/M	LUMEN/M	LUMEN/W	CRI	R9	∅<	LENGTH	SIZE. (W X H)
127-146	IP20	24V	● 2700K	240	10	862	86	>90	54,8	25 mm	5 meters	5 x 1,2 mm
127-145	IP20	24V	● 3000K	240	10	876	87,6	>90	51,8	25 mm	5 meters	5 x 1,2 mm
127-144	IP20	24V	○ 4000K	240	10	899	89,9	>90	68,9	25 mm	5 meters	5 x 1,2 mm

LED Strips | Accessories

LED STRIP POWER CONNECTORS

ART. NR.	FOR LED STRIP	SIZE	IP	USE WITH WIRE
127-401	Single Color	8 mm	IP20	127-250
127-400	Single Color	8 mm	IP52	127-250
127-424	Single Color	8 mm	IP67	127-250
127-405	Single Color	10 mm	IP20	127-250
127-406	Single Color	240 LED/M	IP20	127-250
127-438	Single Color COB	8 mm	IP20	Included
127-411	TW	10 mm	IP20	127-251
127-415	RGB	10 mm	IP20	127-252
127-414	RGB	10 mm	IP52	127-272
127-428	RGB	10 mm	IP67	127-252
127-419	RGBW	12 mm	IP20	127-272
127-418	RGBW	12 mm	IP52	127-272
127-431	RGBTW	12 mm	IP20	127-277
127-430	RGBTW	12 mm	IP67	127-277

LED STRIP SPLICE CONNECTOR

ART. NR.	FOR LED STRIP	SIZE	IP
127-403	Single Color	8 mm	IP20
127-402	Single Color	8 mm	IP52
127-425	Single Color	8 mm	IP67
127-408	Single Color	10 mm	IP20
127-409	Single Color	240 LED/M	IP20
127-439	Single Color COB	8 mm	IP20
127-413	TW	10 mm	IP20
127-417	RGB	10 mm	IP20
127-416	RGB	10 mm	IP52
127-429	RGB	10 mm	IP67
127-422	RGBW	12 mm	IP20
127-421	RGBW	12 mm	IP52
127-432	RGBTW	12 mm	IP67
127-433	RGBTW	10 mm	IP20

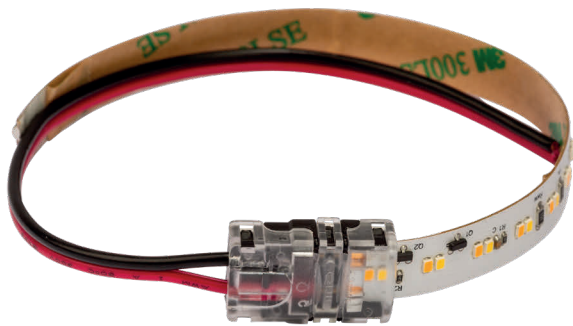

HOW TO CREATE SAFE & EASY LED STRIP CONNECTIONS?

All LED strips are supplied with a wire connection. A LED strip connector or coupling piece is not necessary when applying a LED strip in the standard way. Would you like to link, shorten, extend or connect the LED strip? In that case we have many types of connectors for LED strips to choose from.



POWER CONNECTOR

Power connectors ensure that you can reconnect the end of your (cutted/shortened) LED strip onto an LED power supply, without having to solder! Simply slide the strip into the click connector, click it, and the connection is made. In case of a waterproof LED strip, please make sure to first remove the silicone gel from the strip, and apply some extra glue in the appropriate hole for an IP67 connection.



SPLICE CONNECTOR

To connect two LED Strips to each other, you can use a splice connector. Slide the two strips into the splice connector and click to close. Also note that in case of a waterproof LED strip you must first remove the silicone gel from the strip; then apply some extra glue in the appropriate spot to make the IP67 connection.



Check our website for step-by-step installation manuals

Accessories | LED Strips

LED STRIP WIRE | 2 CORE | PRO METER

ART. NR.
127-250



LED STRIP WIRE | 3 CORE | PRO METER

ART. NR.
127-251



LED STRIP WIRE | 4 CORE | PRO METER

ART. NR.
127-252

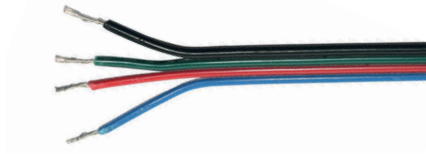

LED STRIP WIRE | 5 CORE | PRO METER

ART. NR.
127-272



LED STRIP WIRE | 6 CORE | PRO METER

ART. NR.
127-277

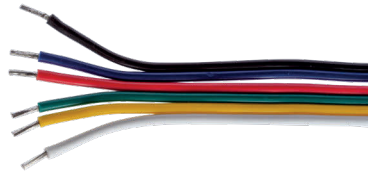

3M TAPE RED | 33,33 METER ROLL

ART. NR.
127-270

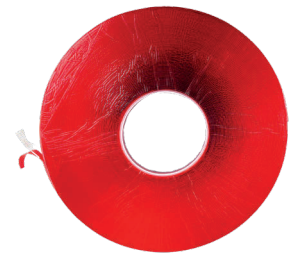

EXTENSION CABLE | 500 CM

ART. NR.
120-109



END CAP FOR IP65 AND IP67 SMD5050

ART. NR.
127-288



END CAP FOR IP65 AND IP67 SMD5050

ART. NR.
127-289



GLUE TUBE

ART. NR.
485-055



3 Modules

The right solution for a wide
variety of applications



Spot Modules

DOWNLIGHT MODULE | 3,3 WATT

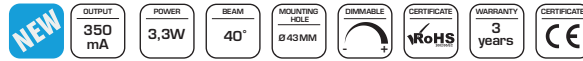

Constant current: 350mA
Power: 3,3 Watt
Driver: Excluded
Dimmable: Yes
Beam angle: 40°
IP rate: IP44 (when mounted)

Diameter: Ø 50 mm
Mounting hole: Ø 43 mm
Height: 33 mm
Connection type: Modular plug
Cable length: 100 cm
Housing: Aluminium/Black/White



ART. NR.	HOUSING COLOR	INPUT VOLTAGE	LUMINOUS FLUX	COLOR TEMP. (CCT)	LIGHT COLOR	CRI
148-151	● Aluminium	9,4 Volt	300 Lm	2700K	○ Warm white+	>90
148-195	○ White	9,4 Volt	300 Lm	2700K	○ Warm white+	>90
148-153	● Black	9,4 Volt	300 Lm	2700K	○ Warm white+	>90
148-150	● Aluminium	9,4 Volt	300 Lm	3000K	○ Warm white	>90
148-194	○ White	9,4 Volt	300 Lm	3000K	○ Warm white	>90
148-152	● Black	9,4 Volt	300 Lm	3000K	○ Warm white	>90

DOWNLIGHT MODULE | 2,5 WATT

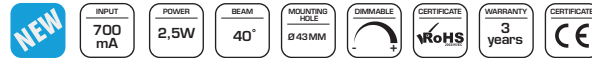

Constant current: 700mA
Power: 2,5 Watt
Driver: Excluded
Dimmable: Yes
Beam angle: 40°
IP rate: IP44 (when mounted)

Diameter: Ø 50 mm
Mounting hole: Ø 43 mm
Height: 24 mm
Connection type: Modular plug
Cable length: 100 cm
Housing: Aluminium/Black/White



ART. NR.	HOUSING COLOR	INPUT VOLTAGE	LUMINOUS FLUX	COLOR TEMP. (CCT)	LIGHT COLOR	CRI
148-149	● Aluminium	3,6 Volt	>182 Lm	2700K	○ Warm white+	>90
148-174	○ White	3,6 Volt	>182 Lm	2700K	○ Warm white+	>90
148-175	● Black	3,6 Volt	>182 Lm	2700K	○ Warm white+	>90
148-119	● Aluminium	3,6 Volt	>182 Lm	3000K	○ Warm white	>90
148-172	○ White	3,6 Volt	>182 Lm	3000K	○ Warm white	>90
148-173	● Black	3,6 Volt	>182 Lm	3000K	○ Warm white	>90
148-111	● Aluminium	3,6 Volt	>182 Lm	6500K	○ Cold white	>80
148-170	○ White	3,6 Volt	>182 Lm	6500K	○ Cold white	>80
148-171	● Black	3,6 Volt	>182 Lm	6500K	○ Cold white	>80

DOWNLIGHT MODULE COB | 1 WATT



Constant current: 350mA
Power: 1 Watt
Driver: Excluded
Dimmable: Yes
Beam angle: 90°
IP rate: IP44 (when mounted)

Diameter: Ø 25 mm
Mounting hole: Ø 21 mm
Height: 17,2 mm
Connection type: Modular plug
Cable length: 100 cm
Housing: Aluminium/Black/White



ART. NR.	HOUSING COLOR	INPUT VOLTAGE	LUMINOUS FLUX	COLOR TEMP. (CCT)	LIGHT COLOR	CRI
148-182	● Aluminium	3,6 Volt	>90 Lm	2700K	○ Warm white+	>90
148-183	○ White	3,6 Volt	>90 Lm	2700K	○ Warm white+	>90
148-184	● Black	3,6 Volt	>90 Lm	2700K	○ Warm white+	>90
148-155	● Aluminium	3,6 Volt	>90 Lm	3000K	○ Warm white	>90
148-180	○ White	3,6 Volt	>90 Lm	3000K	○ Warm white	>90
148-181	● Black	3,6 Volt	>90 Lm	3000K	○ Warm white	>90

Spot Modules

CABINET MODULE | 2,5 WATT



Constant current: 700mA
Power: 2,5 Watt
Driver: Excluded
Dimmable: Yes
Beam angle: 90°
IP rate: IP20

Diameter: Ø 42 mm
Mounting hole: Ø 34 mm
Height: 17 mm
Connection type: Modular plug
Cable length: 75 cm
Housing: Aluminium/Black/White



ART. NR.	HOUSING COLOR	INPUT VOLTAGE	LUMINOUS FLUX	COLOR TEMP. (CCT)	LIGHT COLOR	CRI
148-129	● Aluminium	3,6 Volt	>129 Lm	2700K	○ Warm white+	>90
148-132	○ White	3,6 Volt	>129 Lm	2700K	○ Warm white+	>90
148-133	● Black	3,6 Volt	>129 Lm	2700K	○ Warm white+	>90
148-128	● Aluminium	3,6 Volt	>129 Lm	3000K	○ Warm white	>90
148-130	○ White	3,6 Volt	>129 Lm	3000K	○ Warm white	>90
148-131	● Black	3,6 Volt	>129 Lm	3000K	○ Warm white	>90

PORCH MODULE | 3,3 WATT

Suitable for outdoor terrace or porch lighting



Constant current: 350mA
Power: 3,3 Watt
Driver: Excluded
Dimmable: Yes
Beam angle: 40°
IP rate: IP44 (when mounted)

Diameter: Ø 42 mm
Mounting hole: Ø 34 mm
Height: 27 mm
Connection type: Modular plug
Housing: Aluminium/Black/White



ART. NR.	HOUSING COLOR	INPUT VOLTAGE	LUMINOUS FLUX	COLOR TEMP. (CCT)	LIGHT COLOR	CRI
148-122	● Aluminium	9,4 Volt	300 Lm	2700K	○ Warm white+	>90
148-123	○ White	9,4 Volt	300 Lm	2700K	○ Warm white+	>90
148-124	● Black	9,4 Volt	300 Lm	2700K	○ Warm white+	>90
148-126	● Aluminium	9,4 Volt	300 Lm	3000K	○ Warm white	>90
148-120	○ White	9,4 Volt	300 Lm	3000K	○ Warm white	>90
148-127	● Black	9,4 Volt	300 Lm	3000K	○ Warm white	>90

PORCH MODULE | 2,5 WATT

Suitable for outdoor terrace or porch lighting



Constant current: 700mA
Power: 2,5 Watt
Driver: Excluded
Dimmable: Yes
Beam angle: 40°
IP rate: IP44 (when mounted)

Diameter: Ø 42 mm
Mounting hole: Ø 34 mm
Mounting Height: 25 mm
Connection type: Modular plug
Housing: Aluminium



ART. NR.	HOUSING COLOR	INPUT VOLTAGE	LUMINOUS FLUX	COLOR TEMP. (CCT)	LIGHT COLOR	CRI
148-125	● Aluminium	3,6 Volt	182 Lm	3000K	○ Warm white	>90



Modern toilet area with 2700K Universal Modules

Spot Modules

UNIVERSAL MODULE COB | 6,5 WATT

Fits all regular 50 mm plates.



Constant current: 700mA
Power: 6,5 Watt
Driver: Excluded
LED qty: 1
LED type: CREE COB CXA-1304
Dimmable: Yes
Beam angle: 45°
IP rate: IP44 (when mounted)

Diameter: Ø 50 mm
Height: 61 mm
Connection type: Modular plug
Cable length: 100 cm
Housing: Aluminium/Black/White



ART. NR.	HOUSING COLOR	INPUT VOLTAGE	LUMINOUS FLUX	COLOR TEMP. (CCT)	LIGHT COLOR	CRI
148-163	● Aluminium	9,3 Volt	>509 Lm	2700K	○ Warm white+	>90
148-192	○ White	9,3 Volt	>509 Lm	2700K	○ Warm white+	>90
148-193	● Black	9,3 Volt	>509 Lm	2700K	○ Warm white+	>90
148-162	○ Aluminium	9,3 Volt	>509 Lm	3000K	○ Warm white	>90
148-190	○ White	9,3 Volt	>509 Lm	3000K	○ Warm white	>90
148-191	● Black	9,3 Volt	>509 Lm	3000K	○ Warm white	>90

UNIVERSAL MODULE COB | 9/12 WATT

Fits all regular 50 mm plates.

Available in 2700K, 3000K and flame-dimming.



Constant current: 350/700mA
Driver: Excluded
Power: 9/12 Watt
LED qty: 1
LED type: Epistar COB
Dimmable: Yes
Beam angle: 28°

IP rate: IP44 (when mounted)
Diameter: Ø 50 mm
Height: 62 mm
Connection type: Modular plug
Cable length: 100 cm
Housing: Aluminium



ART. NR.	HOUSING COLOR	POWER	CURRENT	VOLTAGE	LUMINOUS FLUX	COLOR TEMP. (CCT)	LIGHT COLOR	CRI
148-165	● Aluminium	9 watt	350mA	28 Volt	1244 Lm	2700K	○ Warm white+	>90
148-164	● Aluminium	9 watt	350mA	28 Volt	1244 Lm	3000K	○ Warm white	>90
148-169	● Aluminium	12 Watt	700mA	18 Volt	1244 Lm	3000K~2000K	○ Warm white ~ Warm white++	>90

Application possibilities with Universal LED Modules Ø50 mm:



Recessed fixture adjustable

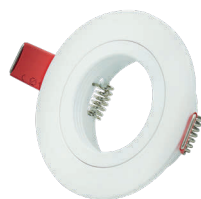

Recessed fixture non adjustable



Ground Spots



Trimless Fixtures



Renovation of existing installations

Spot Modules



1W



3,3W



9W

350mA



NON DIMMABLE SERIES

		POWER	MIN.-MAX.LOAD	MIN.-MAX.LOAD	MIN.-MAX.LOAD
215-412	Indoor	20 Watt	min.1~max.16	min.1~max.6	min.1~max.2



TRIAC DIMMABLE SERIES

		POWER	MIN.-MAX.LOAD	MIN.-MAX.LOAD	MIN.-MAX.LOAD
215-320	Outdoor	4 Watt	min.2~max.3	min.1~max.1	-
215-323	Outdoor	6 Watt	min.3~max.4	min.1~max.3	-
215-379	Indoor	9 Watt	min.4~max.7	min.2~max.2	-
215-380	Indoor	18 Watt	min.8~max.14	min.3~max.5	min.1~max.1
215-205	Indoor	10 Watt	min.2~max.7	min.1~max.3	min.1~max.1



1-10V DIMMABLE SERIES

		POWER	MIN.-MAX.LOAD	MIN.-MAX.LOAD	MIN.-MAX.LOAD
215-205	Indoor	10 Watt	min.2~max.7	min.1~max.3	min.1~max.1
215-601	Indoor	14 Watt	min.1~max.11	min.1~max.4	min.1~max.1
215-602	Indoor	19 Watt	min.1~max.15	min.1~max.5	min.1~max.2



DALI DIMMABLE SERIES

		POWER	MIN.-MAX.LOAD	MIN.-MAX.LOAD	MIN.-MAX.LOAD
215-272	Indoor	12 Watt	min.2~max.9	min.1~max.3	min.1~max.1
215-267	Indoor	14 Watt	min.1~max.11	min.1~max.4	min.1~max.1
215-605	Indoor	19 Watt	min.1~max.15	min.1~max.5	min.1~max.2



CASAMBI SERIES

		POWER	MIN.-MAX.LOAD	MIN.-MAX.LOAD	MIN.-MAX.LOAD
214-206	Indoor	150 Watt	With Triac Driver	With Triac Driver	With Triac Driver
215-267 + 214-231	Indoor	14 Watt	min.1~max.11	min.1~max.4	min.1~max.1
215-605 + 214-231	Indoor	19 Watt	min.1~max.15	min.1~max.5	min.1~max.2



LED Module Divider | 3 outlets Art. nr. 148-306



LED Module Divider | 6 outlets Art. nr. 148-302

Spot Modules



700mA



NON DIMMABLE SERIES		POWER	MIN.-MAX.LOAD	MIN.-MAX.LOAD	MIN.-MAX.LOAD
215-202	Indoor	6 Watt	min.1~max.2	-	-
215-211	Indoor	12 Watt	min.1~max.4	min.1~max.1	-
215-212	Indoor	20 Watt	min.1~max.8	min.1~max.3	min.1~max.1
215-221	Indoor	36 Watt	min.1~max.14	min.1~max.5	min.1~max.3



TRIAC DIMMABLE SERIES		POWER	MIN.-MAX.LOAD	MIN.-MAX.LOAD	MIN.-MAX.LOAD
215-322	Outdoor	4 Watt	min. 1~max.1	-	-
215-325	Outdoor	6 Watt	min. 2~max.2	min.1~max.1	-
215-279	Indoor	9 Watt	min. 3~max.3	-	-
215-280	Indoor	18 Watt	min. 4~max.7	min. 2~max.2	min.1~max.1
215-281	Indoor	25 Watt	min. 5~max.10	min. 2~max.4	-
215-206	Indoor	50 Watt	min. 3~max.13	min. 1~max.5	-



1-10V DIMMABLE SERIES		POWER	MIN.-MAX.LOAD	MIN.-MAX.LOAD	MIN.-MAX.LOAD
215-601	Indoor	20 Watt	min.1~max.7	min.1~max.2	min.1~max.1
215-602	Indoor	30 Watt	min.1~max.12	min.1~max.4	min.1~max.2



DALI DIMMABLE SERIES		POWER	MIN.-MAX.LOAD	MIN.-MAX.LOAD	MIN.-MAX.LOAD
215-267	Indoor	20 Watt	min.1~max.7	min.1~max.2	min.1~max.1
215-605	Indoor	30 Watt	min.1~max.12	min.1~max.4	min.1~max.2



CASAMBI SERIES		POWER	MIN.-MAX.LOAD	MIN.-MAX.LOAD	MIN.-MAX.LOAD
214-206	Indoor	150 Watt	With Triac Driver	With Triac Driver	With Triac Driver
215-267 + 214-231	Indoor	20 Watt	min.1~max.7	min.1~max.2	min.1~max.1
215-605 + 214-231	Indoor	30 Watt	min.1~max.12	min.1~max.4	min.1~max.2



LED Module Extension Cable | 2M Art. nr. 148-303
5M Art.nr 148-304 | 10M Art.nr 148-305

4

Advertising & Signing

Powerful lighting tools for advertising purposes

VAN TILBURG



SPORT

STAPELKORTING
40%
30%
20%
10%

van Tilburg

SPORT

Advertising & Signing | Modules

BACKGROUND MODULE | HIGH POWER LED

Input voltage: 12V
Power: 1,1 Watt
Module qty: 50 modules / 8 meter
Max. to connect: 50
LED qty per module: 3
LED type: SMD2835
Dimmable: Yes

Beam angle: 160°
IP rate: IP65
Length: 74.4 mm
Width: 15 mm
Height: 9.2 mm
Connection Type: Stripped wire



ART. NR.	COLOR TEMP. (CCT)	LIGHT COLOR	LUMINOUS FLUX
125-071	7000K	● Cold white	106 Lm
125-078	3000K	● Warm white	106 Lm

BACKGROUND MODULE | RGB

Input voltage: 12V
Power: 0,72 Watt
Module qty: 50 modules / 8,5 meter
Max. to connect: 20
LED qty per module: 3
LED type: Epistar 5050

Dimmable: Yes
Beam angle: 120°
IP rate: IP65
Length: 62 mm
Width: 17 mm
Height: 2,8 mm
Connection Type: Stripped wire



ART. NR.	COLOR TEMP. (CCT)	LIGHT COLOR	LUMINOUS FLUX
125-000	n/a	● RGB	n/a

BACKGROUND MODULE | RGBW | 3000K

Input voltage: 12V
Power: 0,96 Watt
Module qty: 50 modules / 7 meter
Max. to connect: 20
LED qty per module: 3
LED type: SMD5050
Dimmable: Yes

Beam angle: 160°
IP rate: IP65
Length: 81 mm
Width: 17,5 mm
Height: 8,2 mm
Connection Type: Stripped wire



ART. NR.	COLOR TEMP. (CCT)	LIGHT COLOR	LUMINOUS FLUX
125-010	RGBW	● RGB + Warm white	n/a

BACKGROUND MODULE | 7000K

Input voltage: 12V
Power: 0,4 Watt
Module qty: 50 modules / 8,5 meter
Max. to connect: 20
LED qty per module: 1
LED type: SMD2835

Dimmable: Yes
Beam angle: 170°
IP rate: IP66
Length: 36 mm
Width: 17,5 mm
Height: 6,2 mm
Connection Type: Stripped wire



ART. NR.	COLOR TEMP. (CCT)	LIGHT COLOR	LUMINOUS FLUX
125-061	7000K	● Cold white	40 Lm



Blokker store with brand logo lighted by Background Modules

Advertising & Signing | Neon flex PRO

Neon Flex Professional: the best alternative to conventional Neon lighting

Neon Flex is a high quality, flexible rope light with the apparent looks of conventional neon light. High durability, low energy consumption and exceptional flexibility makes Neon Flex the perfect alternative to conventional fluorescent neon lighting.

- Availability in 6 Colors & RGB
 - Dimensions on request
 - Plug & Play due moulded Power cable (3 meters)
 - IP68, Flame-, saltwater-, solvents- and UV resistant
 - SMD5050 LED & PCB housing
- Limited availability, order on request

Neon Flex Professional: het conventionele Neon verlichting alternatief

Neon Flex is een hoge kwaliteit, flexibele lichtslang met het uiterlijk van conventioneel neonlicht. Lange levensduur, laag energieverbruik én uitzonderlijke flexibiliteit maakt Neon Flex een perfect alternatief voor fluoriserende neon verlichting.

- Verkrijgbaar in 6 kleuren & RGB
 - Afmetingen op aanvraag
 - Plug & Play door gegoten aansluitkabel (3 meter)
 - IP68, vlam-, zoutwater-, oplosmiddel- en UV resistent
 - SMD5050 LED & PCB behuizing
- Bepaalde voorraad, op aanvraag leverbaar

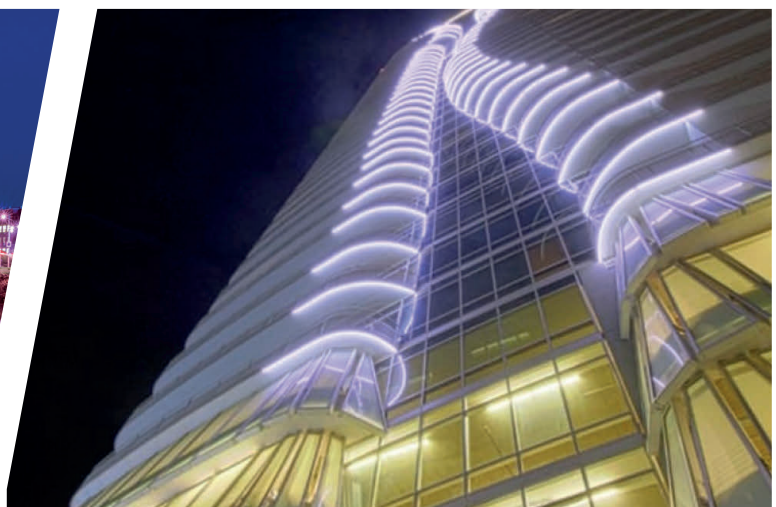

Neon flex PRO | Advertising & Signing

LIMITED
AVAILABILITY,
ORDER ON
REQUEST



DIGITAL RGB

The power of light communication



- Dimensions on request
- IP68, Flame-, saltwater-, solvents- and UV resistant
- WCS2903 IC, SPI signal input. Controller: DMX512 signal compatible, DMX address writable or programmable

TRONIX NEON FLEX IN 4 VARIANTS

The different types of Neon Flex are based on hose thickness (flexibility) and design (flat or round top). The top of the neon flex is also the light output side and determines the desired light effect. The Up & Down variant has the light output on the side. The flat version gives a more modern look; the round version more of a classic or retro effect.

TRONIX NEON FLEX IN 4 VARIANTEN

De verschillende types Neon Flex verschillen van elkaar in slangdikte (buigzaamheid) en design (platte of ronde bovenkant). De bovenkant van de neon flex is tevens de lichtzijde en bepalend voor het gewenste lichteffect. De Up & Down variant heeft de lichtoutput aan de zijkant. De platte (flat) versie geeft een modernere uitstraling; de ronde versie meer een klassiek of retro effect.

NEON FLEX PRO

Available in White, Warm White, Blue, Green, Red, Amber and Yellow

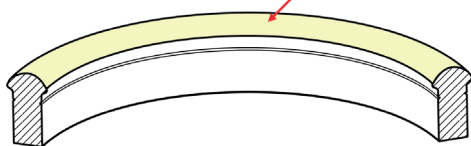

NEON FLEX FLAT

Available in White, Warm White and RGB

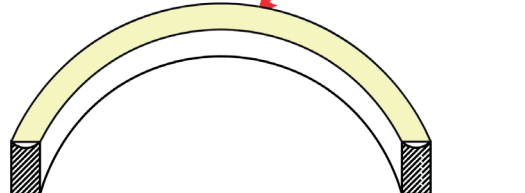

NEON MINI FLAT

Available in White and Warm White

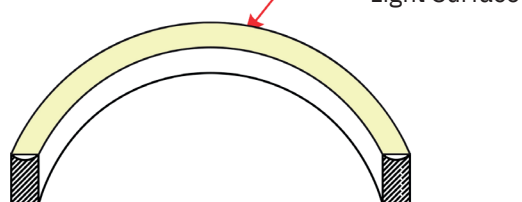

NEON FLEX UP & DOWN

Available in White and Warm White

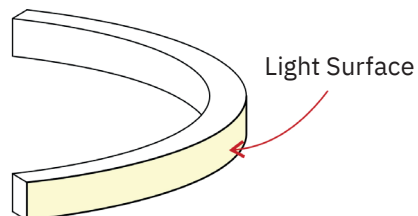

FIND OUT MORE ABOUT NEON FLEX AND THE BEST CHOICE FOR YOUR APPLICATION?

We are happy to advice and futher assist you at sales@tronixlighting.com | +31 (0)413 33 03 80

MEER WETEN OVER NEON FLEX EN DE BESTE KEUZE VOOR UW TOEPASSING?

Wij helpen u graag verder op sales@tronixlighting.com | +31 (0)413 33 03 80





5 Wall Washers

Drawing attention to larger
surfaces and buildings





KUSTERS
LUMINOUS
SOLUTIONS



Architectural company building with aluminium construction panels illuminated by Tronix Wall Washers (Art. nr. 190-090) Kusters Oss - The Netherlands

Wall Washers

WALL WASHER | RGBW | 1 METER

Powerful 48W illumination with ultra-bright lighting effect.



Input voltage: 24V / DMX

Power: 48 Watt

LED qty: 18

LED type: Osram 3535

Beam angle: 15° x 55°

IP rate: IP65

Connection type: Modular plug

Wire length: 30 cm in, 30 cm out

Material: Aluminium, Black

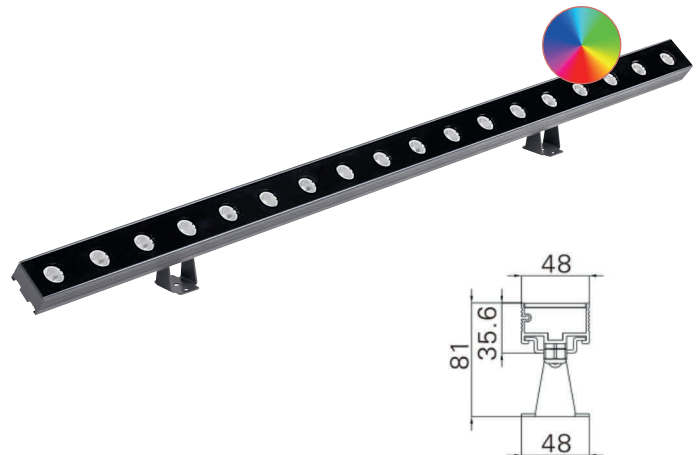

ART. NR.	SIZE	COLOR TEMP. (CCT)	LIGHT COLOR	LUMINOUS FLUX	WIRE LENGTH
190-090	1000 x 58 x 124 mm	3000K	RGB	376 Lm (Warm white) 1149 Lm (RGB Full on)	30 cm in 30 cm out

ART. NR.	ACCESSORIES
190-094	Power cable 24V/DMX 3M IP65 Male Plug
190-095	Power cable 24V/DMX 3M IP65 Female Plug
190-096	Extension cable 24V/DMX 1M IP65 Male/Female Plug
190-097	Extension cable 24V/DMX 5M IP65 Male/Female Plug
190-098	T-connector 24V/DMX IP65 1x Male 2x Female Plug
190-100	End Cap For connector Wall Washer 190-190



*Wiring diagram Wall Washers



RGBW ALUMINIUM WALL WASHER 1M

Designed for a high-powered color wash that can easily illuminate several metres down walls or across ceilings, this wall washer is ideal for signage and lighting of e.g. hotels, restaurants, clubs and bars. Create any imaginable color light shade effect mixing red, blue, green and white led's right at the source.

- **Powerful 48W** illumination with ultra-bright lighting effect
- **With 18 RGBW** Samsung Led's p/m and 15x55° optic lens for maximum light reach
- **IP65** water-resistant and dustproof for outdoor use
- **Easy controlling** with Tronix DMX Controller Art. 214-135 (also compatible with any other brand DMX controller)
- **Power up to 3 pcs** with just one power supply and up to 6 pcs with one on each end.
- **Special T-connector** available to easily place more wall washers in one line (with built-in DMX signal up to 60m reach in 1 line)
- **Equipped with rotating fixing brackets:** screw in position and fix on the right angle.



*Tronix RGBW Spot illuminates tree
in private residential garden*

Wall Washers

SPOT | 24V | 24W | 30° | IP66 | RGBW | DMX512

Powerful 24W illumination with ultra-bright lighting effect. Perfect to illuminate buildings, objects or trees.



Input voltage: 24V / DMX

Power: 24 Watt

LED qty: 3

LED type: Osram

Beam angle: 30°

IP rate: IP66

Connection type: Modular plug

Wire length: 25 cm in, 25 cm out.

Material: Aluminium, Black coated



ART. NR.	SIZE	COLOR TEMP. (CCT)	LIGHT COLOR	LUMINOUS FLUX	WIRE LENGTH
190-150	270 x Ø130/111 mm	3000K	RGB	480 Lm (Warm white) 840 Lm (RGB Full on)	25 cm in 25 cm out

ART. NR.	ACCESSORIES
190-094	Power cable 24V/DMX 3M IP65 Male Plug
190-095	Power cable 24V/DMX 3M IP65 Female Plug
190-096	Extension cable 24V/DMX 1M IP65 Male/Female Plug
190-097	Extencion cable 24V/DMX 5M IP65 Male/Female Plug
190-098	T-connector 24V/DMX IP65 1x Male 2x Female Plug
190-100	End Cap For connector Wall Washer 190-190



*Wiring diagram RGB Spot

Register

120-109	65	127-088	54	127-182	55	148-122	69
125-000	76	127-089	54	127-183	55	148-123	69
125-010	76	127-090	62	127-190	55	148-124	69
125-061	76	127-092	55	127-191	55	148-125	69
125-071	76	127-093	55	127-192	55	148-126	69
125-078	76	127-094	55	127-193	55	148-127	69
127-000	56	127-095	55	127-194	55	148-128	69
127-001	54	127-096	55	127-195	55	148-129	69
127-002	54	127-101	56	127-196	55	148-130	69
127-003	54	127-102	56	127-197	55	148-131	69
127-004	54	127-104	56	127-198	55	148-132	69
127-005	54	127-106	56	127-250	65	148-133	69
127-008	54	127-111	58	127-251	65	148-149	68
127-010	56	127-112	58	127-252	65	148-150	68
127-013	54	127-113	58	127-270	65	148-151	68
127-014	54	127-114	58	127-272	65	148-152	68
127-033	60	127-115	58	127-277	65	148-153	68
127-034	60	127-116	55	127-288	65	148-155	68
127-035	60	127-117	58	127-289	65	148-162	71
127-039	54	127-118	54	127-400	64	148-163	71
127-041	54	127-119	54	127-401	64	148-164	71
127-042	54	127-121	60	127-402	64	148-165	71
127-043	54	127-122	60	127-403	64	148-169	71
127-044	54	127-123	60	127-405	64	148-170	68
127-046	54	127-124	60	127-406	64	148-171	68
127-049	54	127-129	61	127-408	64	148-172	68
127-057	54	127-130	62	127-409	64	148-173	68
127-058	54	127-131	62	127-411	64	148-174	68
127-059	54	127-132	62	127-413	64	148-175	68
127-060	54	127-133	61	127-414	64	148-180	68
127-062	63	127-138	56	127-415	64	148-181	68
127-063	56	127-140	62	127-416	64	148-182	68
127-065	54	127-144	63	127-417	64	148-183	68
127-066	54	127-145	63	127-418	64	148-184	68
127-067	54	127-146	63	127-419	64	148-190	71
127-069	55	127-150	63	127-421	64	148-191	71
127-070	56	127-151	63	127-422	64	148-192	71
127-073	55	127-152	63	127-424	64	148-193	71
127-074	55	127-155	60	127-425	64	148-194	68
127-075	56	127-156	60	127-428	64	148-195	68
127-077	63	127-157	60	127-429	64	190-090	85
127-078	54	127-158	60	127-430	64	190-094	85
127-079	56	127-160	60	127-431	64	190-094	87
127-080	63	127-161	60	127-432	64	190-095	85
127-081	63	127-162	60	127-433	64	190-095	87
127-082	54	127-163	60	127-438	64	190-096	85
127-083	56	127-171	54	127-439	64	190-096	87
127-084	56	127-172	54	148-111	68	190-097	85
127-085	57	127-173	54	148-119	68	190-097	87
127-086	57	127-181	55	148-120	69	190-098	85



Register

190-098	87	214-158	41	214-351	28	215-280	16
190-100	85	214-159	42	214-352	28	215-281	16
190-100	87	214-159	56	214-352	45	215-282	16
190-150	87	214-166	43	214-353	45	215-295	30
214-050	48	214-166	57	214-354	23	215-296	30
214-051	48	214-168	42	214-355	28	215-315	14
214-052	49	214-169	42	214-356	28	215-316	14
214-055	50	214-172	42	214-357	28	215-317	14
214-056	50	214-172	56	214-950	39	215-318	14
214-057	50	214-173	40	214-999	39	215-319	14
214-058	50	214-173	42	215-002	13	215-320	16
214-060	49	214-174	41	215-003	17	215-321	16
214-061	49	214-175	42	215-004	17	215-322	16
214-090	38	214-175	56	215-005	13	215-323	16
214-113	44	214-176	29	215-006	13	215-324	16
214-115	44	214-177	29	215-009	13	215-325	16
214-118	38	214-178	42	215-010	13	215-379	16
214-119	48	214-178	57	215-011	13	215-380	16
214-120	48	214-179	22	215-012	13	215-403	13
214-123	38	214-181	44	215-013	13	215-404	17
214-127	39	214-182	46	215-014	17	215-408	13
214-128	39	214-183	46	215-015	17	215-409	13
214-130	40	214-184	41	215-016	17	215-412	12
214-131	40	214-199	31	215-019	17	215-414	13
214-132	41	214-202	31	215-081	14	215-422	13
214-133	41	214-202	49	215-082	14	215-423	13
214-134	40	214-203	31	215-083	14	215-424	13
214-135	46	214-203	49	215-084	14	215-430	14
214-136	22	214-204	31	215-131	19	215-509	22
214-137	22	214-205	31	215-133	24	215-517	22
214-139	46	214-206	31	215-134	29	215-601	23
214-140	44	214-231	30	215-205	20	215-602	23
214-141	44	214-232	30	215-206	21	215-603	23
214-142	42	214-250	35	215-211	12	215-605	27
214-143	43	214-255	35	215-212	12	215-606	27
214-143	56	214-257	35	215-214	16	215-621	23
214-144	40	214-262	34	215-220	12	215-622	23
214-145	40	214-270	35	215-221	12	215-623	23
214-146	40	214-271	36	215-222	12	215-625	27
214-147	41	214-275	36	215-265	26	215-641	27
214-150	41	214-276	36	215-266	26	215-642	27
214-151	41	214-277	36	215-267	27	215-646	27
214-152	40	214-300	32	215-268	27	215-681	45
214-153	43	214-305	32	215-269	27	215-685	28
214-155	42	214-315	32	215-271	27	215-685	45
214-156	29	214-350	28	215-272	26	485-055	65
214-157	42	214-350	45	215-279	16		

