



GALAXY[®] profiles

Perfect Light Lines

2026

DE | EN



INTELLIGENT PRODUCT DESIGN

Profile systems from GALAXY® profiles combine sophisticated functionality with timeless aesthetics and imbue every illuminated area with homogeneous light. There are profiles for incorporating into furniture, for stage décor and lighting effects, for use in the atmospheric lighting of living areas, or in complex LED lighting concepts in the industrial sector. We offer high quality aluminium profile systems for to meet all requirements!

Take advantage of our years of experience!



UNLIMITED DESIGN FLEXIBILITY

Trademark profiles from GALAXY® profiles protect LED strips from mechanical impacts, dissipate heat, and integrate perfectly into any architectural feature. The standard portfolio covers a wide range of requirements for profiles for trend-setting LED lighting concepts. Our product designers are constantly developing new profile systems and are also able to meet any individual customer requirement from within our standard OEM range.

Take advantage of our expertise!



GUARANTEED QUALITY AT THE BEST PRICE

Profile systems from GALAXY® profiles are produced in accordance with strict quality criteria on modern, fully automatic precision equipment and using raw materials that meet the highest quality classification. All business processes are subject to the GALAXY®'s quality management and monitored with certified inspection procedures. We offer a five-year guarantee on our profiles, a three-year guarantee on our covers and a five-year guarantee on all other LED profile components. Check out our products and services for yourself!

Take advantage of our full service!



INTELLIGENTES PRODUKTDESIGN

Profilsysteme von GALAXY® profiles vereinen raffinierte Funktionalität und zeitlose Ästhetik und erfüllen jedes zu beleuchtende Objekt mit homogener Lichtqualität. Profile für die Montage in Möbeln, für inszenierende Dekor-/Effektbeleuchtung, für den Einsatz in atmosphärischer Wohnraumbelichtung oder in komplexen LED Beleuchtungskonzepten für den Industriebereich. Wir bieten Qualitäts-Profilsysteme aus Aluminium für jede Anforderung!

Profitieren Sie von unserer langjährigen Erfahrung!



GRENZENLOSE DESIGNVIELFALT

Marken-Profile von GALAXY® profiles schützen LED Strips vor mechanischen Einwirkungen, wirken wärmeableitend und integrieren sich perfekt in jede architektonische Gegebenheit. Das Standardsortiment deckt ein breites Anforderungsspektrum an Profilen für zukunftsweisende LED Beleuchtungskonzepte ab. Unsere Produktdesigner entwickeln laufend neue Profilsysteme und realisieren zudem jeden individuellen Kundenwunsch im Rahmen unserer serienmäßigen OEM-Fertigung.

Profitieren Sie von unserem Know-how!



GARANTIERTE QUALITÄT ZUM BESTEN PREIS

Profilsysteme von GALAXY® profiles werden auf modernen, vollautomatischen Präzisionsanlagen aus hochwertigen Rohstoffen der besten Güteklasse nach strengsten Qualitätskriterien produziert. Sämtliche Unternehmensprozesse unterliegen dem GALAXY® Qualitätsmanagement und werden mit zertifizierten Prüfverfahren überwacht. Wir gewähren auf unsere Profile fünf Jahre Garantie, drei Jahre Garantie für unsere Cover und fünf Jahre für alle anderen LED Profilkomponenten. Überzeugen Sie sich von unseren Produkten und Leistungen!

Profitieren Sie von unserem Full-Service!

INDEX | INHALT GALAXY® PROFILES

6	Customer satisfaction survey	6	Kundenzufriedenheitsumfrage
8	Protected product design for the global market	8	Geschütztes Produktdesign für den Weltmarkt
10	INDEX Profiles by installation types	10	INDEX Profile nach Montageart
17	Reference Gallery	17	Reference Gallery
18	INDEX Covers	18	INDEX Abdeckungen
22	Sample	22	Muster
24	About us	24	Über uns
25	Design Diversity	25	Designvielfalt
26	Perfect Light Lines	26	Perfect Light Lines
27	Customized assembling and standard special production (OEM)	27	Konfektionierung und serienmäßige Sonderanfertigung (OEM)
28	Customer-Specific assembling	28	Kundenspezifische Konfektionierung
29	Use in wet rooms and outdoors	29	Einsatz in Nasszellen und Outdoor
30	Independent linear LED lighting systems	30	Eigenständige Lineare LED Leuchtensysteme
32	Homogeneous lighting with perfect light lines	32	Homogeneous lighting with perfect light lines
446	INDEX by profile systems	446	INDEX nach Profilsystemen
450	Material usage	450	Materialeinsatz
451	Your added value by GALAXY® profiles! Join now!	451	Ihr Mehrwert mit GALAXY® profiles! Jetzt registrieren!

LED Profile Systems

34	BL1	112	PO23	206	FP8V2	288	SP2	370	PK1
34	BL2	116	PO23V2	210	PI3V2	292	SF1	374	PK2
38	PL1	120	PN4	214	TBP1	296	NL8	378	PK3
42	PL2	126	PN5	218	TBP2	300	NL8F	382	PK8
46	PL3	132	PN6V2	218	TBP2.1	304	NL15	386	VP1
50	PL4	138	PN7V2	224	TBP3	308	NL15F	390	VP2
54	PL5	144	PN8	228	TBP4	312	NL10	394	VP3
60	PL6	148	PN10	232	TBP5	316	VA1	398	VP5
66	PL8	152	PN17V1	238	TBP6	320	VA2	405	SV1
70	PL10.1	158	PN17V2	242	TBP7	324	VA3	405	SV2
70	PL10	164	PN27	246	TBP10	328	VA4	405	SV3
76	PL11	170	PN19V3	250	TBP11	332	VA5	405	SV4
80	PL13	174	PN20V2	254	TBP12	336	VA6	406	Z50
84	PO5	178	PN21	258	TBP13	340	MP1	407	Z51
88	PO13	182	PN33	262	TBP14	344	MP2	414	PA1
92	PO14	186	FP1	266	TBP16	348	MP3	420	GP20
96	PO15	190	FP2	270	RP	352	MP4	424	DP10
100	PO16	194	FP3	274	SR	356	BP2	428	T48/20
104	PO17	198	FP4	278	LL2	360	PA3		
108	PO18	202	FP5	284	SP1	366	WP1		

PUR Grouting | PUR-Vollverguss

410	Sustainable profile sealing (IP67)	410	Nachhaltige Profil-Versiegelung (IP67)
414	PA1	414	PA1

Accessories | Zubehör

440	Cleaning Degreasing	440	Reinigung Entfettung
441	Mounting Adhesive/Adhesive Tape/ Protective Materials	441	Montagekleber/Klebebänder/Schutzmaterial
443	Sealant/Filler/Impregnation	443	Abdichtung/Füllmaterial/Imprägnierung



recycled aluminium



max.
xx mm

Max. width of LED Strip
maximale Flexbandbreite



SURFACE Profile
AUFBAU-Profil



Linear LED pendant lamp
Lineare LED Hängeleuchte
MORE ON P. 30 | MEHR AUF S. 30



RECESSED Profile
EINBAU-Profil

OEM

Packaging and standard
special production
Konfektionierung und
serienmäßige Sonderanfertigung
MORE ON P. 27/28 | MEHR AUF S. 27/28



suitable for wet rooms
and outdoors

geeignet für Nasszellen
und Outdoor

MORE ON P. 29 | MEHR AUF S. 29



Only suitable for indoor use
Nur für den Innenbereich geeignet
MORE ON P. 450 | MEHR AUF S. 450

GALAXY® profiles GmbH

Zeller Berg 2c
6330 Kufstein
Austria | Europe
☎ +43 5372 22260
info@galaxy-profiles.com
www.galaxy-profiles.com



Light cones

Visual representations of light cones are non-binding and are for visualisation purposes only. Binding sketches can only be created based on actual photometric data.

Lichtkegel

Die Darstellungen der Lichtkegel sind nicht verbindlich und dienen lediglich der Veranschaulichung. Verbindliche Skizzen können ausschließlich basierend auf tatsächlichen photometrischen Daten erstellt werden.

Please note: Information on features serves to better describe our products but should not be considered as corresponding to guaranteed characteristics unless expressly designated as such. / GALAXY reserves the right to introduce changes to favour technical progress or adaptations in compliance with changing standards or regulations. / Photos and drawings in this catalogue are mere design examples and are not binding for delivery design. / GALAXY® profiles GmbH shall assume no responsibility for any unavailability of catalogue products. / GALAXY® profiles GmbH shall assume no responsibility for any direct, indirect, incidental or other damages (including, but not limited to, lost profits, lost revenues, or similar economic loss) arising from the use of information contained in this catalogue. / Violation of intellectual property rights or use of text and layout design (incl. photos) without our permission is prohibited and will be prosecuted.

Bitte beachten Sie: Die Angaben dienen der näheren Artikelbeschreibung, sind jedoch keine zugesicherten Eigenschaften, wenn sie nicht ausdrücklich als solche bezeichnet werden. / Änderungen zu Gunsten des technischen Fortschrittes bzw. Anpassungen an geänderte Normen oder Vorschriften bleiben vorbehalten. / Fotos und Zeichnungen in diesem Katalog sind Ausführungsbeispiele und nicht verbindlich für die Ausführung der Lieferung. / Die Firma GALAXY® profiles GmbH haftet nicht für eine eventuelle Nichtverfügbarkeit der Katalogprodukte. / Die GALAXY® profiles GmbH haftet ebenfalls nicht für jegliche direkte, indirekte, zufällige oder andere Schäden (darunter auch, aber nicht ausschließlich, für entgangene Gewinne, entgangene Erträge oder ähnliche wirtschaftliche Schäden), die durch die Verwendung von Informationen aus diesem Katalog entstehen. / Ein Verstoß gegen Schutzrechte oder eine Verwendung von Text- und Layoutgestaltung (inkl. Fotos) ohne unsere Genehmigung ist nicht gestattet und wird gerichtlich verfolgt.



90%

CONSIDER OURSELVES TO BE ONE OF THE
MARKET LEADERS IN THESE AREAS

SEHEN UNS ALS EINER DER MARKTFÜHRER
IN DIESEN BEREICHEN

Service/Consulting | Service/Beratung

Quality | Qualität

Price/performance | Preis-/Leistung

Deliverability | Lieferfähigkeit

Returns management | Retourenabwicklung

Marketing activity | Marketingaktivität

**CUSTOMER SATISFACTION SURVEY
KUNDENZUFRIEDENHEITSUMFRAGE**

2025

100%

RECOMMENDATION RATE THANKS TO THESE FACTORS WEITEREMPFEHLUNG DANK DIESER FAKTOREN



CUSTOMER SERVICE THROUGH SALES

The majority of our customers are very satisfied with the availability and reliability of our sales team, both in-house and in the field. They particularly highlight the competent and friendly expert advice, which contributes significantly to smooth cooperation.

KUNDENSERVICE DURCH VERTRIEB

Die Mehrheit unserer Kunden zeigt sich sehr zufrieden mit der Erreichbarkeit und Zuverlässigkeit unseres Vertriebs, sowohl im Innen- als auch im Außendienst. Besonders hervorgehoben wird die kompetente und freundliche Fachberatung, die maßgeblich zu einer reibungslosen Zusammenarbeit beiträgt.



PRODUCT RANGE:

Our customers are enthusiastic about our versatile and well-designed product range and the first-class product quality, which offers the right solution for almost every need. The high product availability, which enables smooth planning and rapid implementation of projects, is also particularly appreciated.

PRODUKTSORTIMENT:

Unsere Kunden zeigen sich begeistert von unserem vielseitigen und durchdachten Produktsortiment und der erstklassigen Produktqualität, die für nahezu jedes Bedürfnis die passende Lösung bietet. Besonders geschätzt wird zudem die hohe Produktverfügbarkeit, die eine reibungslose Planung und schnelle Umsetzung von Projekten ermöglicht.



PRODUCT INFORMATION & TECHNICAL DOCUMENTATION:

Our customers particularly appreciate the comprehensive availability of our technical documents, precise product data and clear sketches and videos. The clearly structured documentation and easy-to-understand media not only assist in product selection, but also offer maximum guidance during use.

PRODUKTINFOS & TECHNISCHE DOKUMENTATION:

Unsere Kunden schätzen besonders die umfassende Verfügbarkeit unserer technischen Dokumente, präzisen Artikeldaten sowie anschaulichen Skizzen und Videos. Die klar strukturierten Unterlagen und leicht verständlichen Medien unterstützen nicht nur bei der Produktauswahl, sondern bieten auch im Einsatz maximale Orientierung.



RELIABILITY OF DELIVERY:

The majority of our customers are very satisfied with our adherence to confirmed delivery dates. Delivery reliability is particularly important to us, as it enables our customers to plan their projects reliably and meet deadlines without fail.

LIEFERZUVERLÄSSIGKEIT:

Mit der Einhaltung der bestätigten Liefertermine sind unsere Kunden mehrheitlich sehr zufrieden. Die Liefertreue ist uns besonders wichtig, damit wir unseren Kunden eine verlässliche zeitliche Planung ihrer Projekte ermöglichen und Deadlines zuverlässig eingehalten werden können.

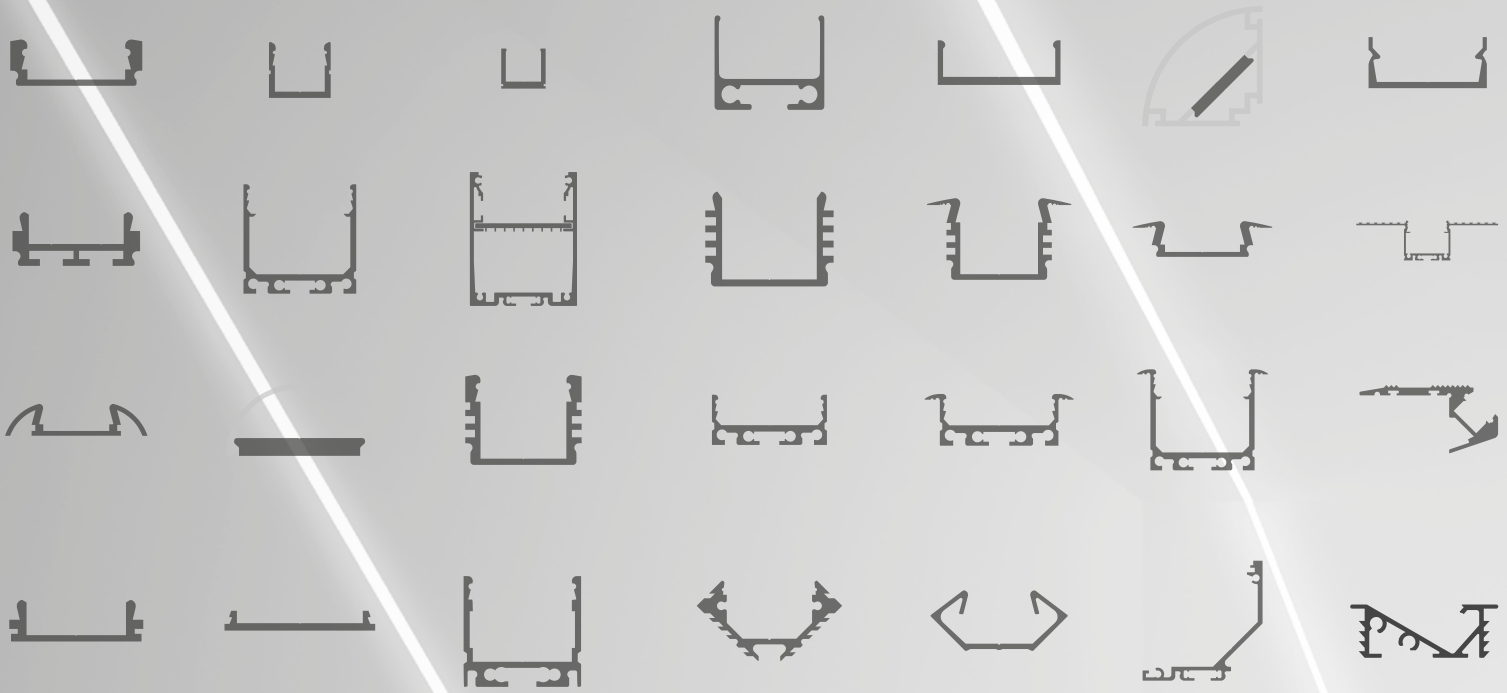

Protected product design for the global market

- Protected product design for all profile systems
- Unique product compatibility
- Production on modern, fully automated, precision equipment
- Top quality raw materials
- Strictest quality criteria
- Multi-level quality assurance
- Internal quality assurance and lighting laboratory
- Refined aluminium components
 - Hardened and sealed
 - Free of contamination and inclusions
 - Protection of atmospheric impacts
- ROHS (certificate of purity)
- CE certification

**5 YEARS WARRANTY ON OUR PROFILES,
3 YEARS WARRANTY ON OUR COVERS AND
5 YEARS GUARANTEE ON ALL COMPONENTS
OF OUR PROFILE SYSTEMS!**

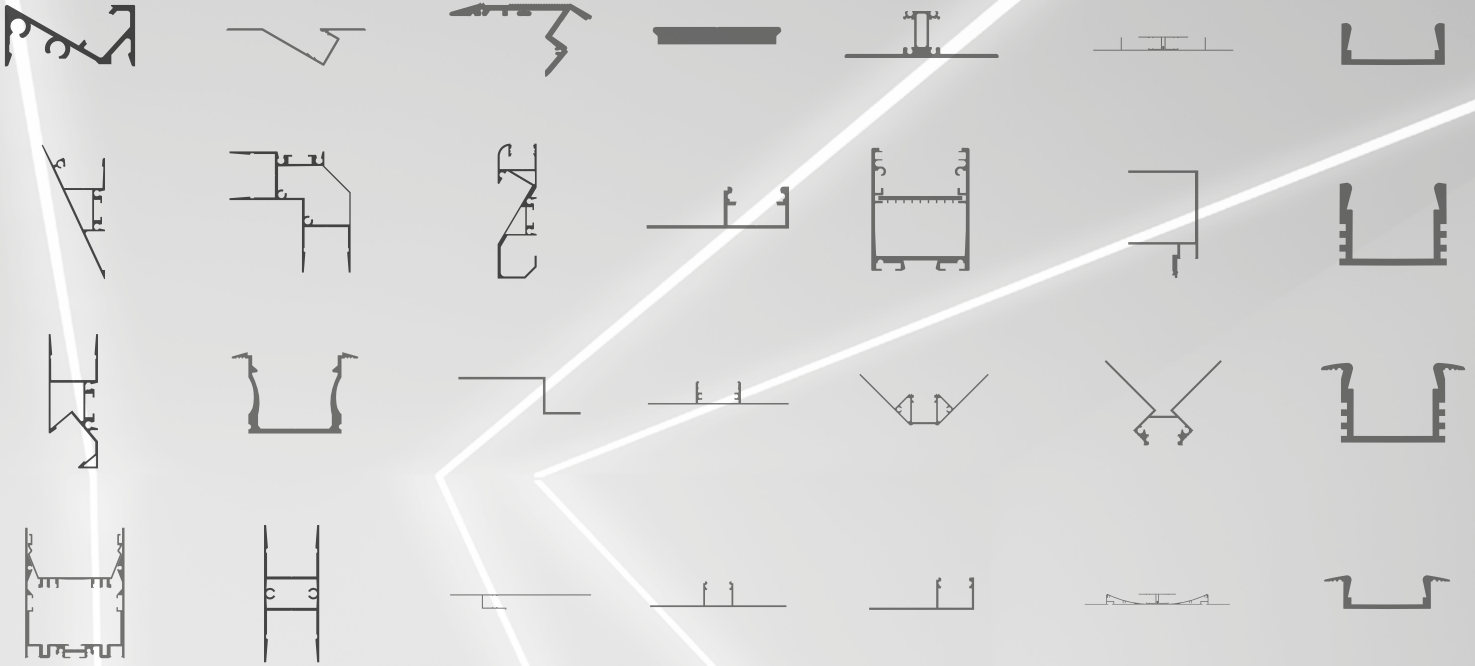

Geschütztes Produktdesign für den Weltmarkt

- Designschutz aller Profilsysteme
- Einzigartige Produktkompatibilität
- Produktion auf modernen, vollautomatischen Präzisionsanlagen
- Rohstoffe bester Güteklasse
- Strengste Qualitätskriterien
- Mehrstufige Qualitätssicherung
- Hauseigenes QS- & Lichtlabor
- Veredelte Aluminiumkomponenten
 - Gehärtet und versiegelt
 - Frei von Verunreinigungen und Einschlüssen
 - Geschützt vor atmosphärischen Einwirkungen
- ROHS (Reinheitszertifikat)
- CE-Zertifizierung

**5 JAHRE GARANTIE AUF UNSERE PROFILE,
3 JAHRE GARANTIE AUF UNSERE COVER UND
5 JAHRE GARANTIE AUF ALLE KOMPONENTEN
UNSERER PROFILSYSTEME!**

INDEX BY INSTALLATION TYPES | NACH MONTAGEART



SURFACE | AUFBAU



PO18 S. 108

max. 6 mm

ITEM NO. | ART. NR.

■ 2m 8101060

■ 2m 8101062

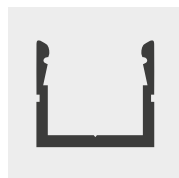

PO16 S. 100

max. 8 mm

ITEM NO. | ART. NR.

■ 2m 8101050

■ 3m 8101054

■ 2m 8101051

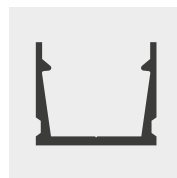

PL4 S. 50

max. 10 mm

ITEM NO. | ART. NR.

■ 2m 8122000

■ 3m 8122002

□ 2m 8102240

□ 3m 8102242

■ 2m 8122020

■ 3m 8122022

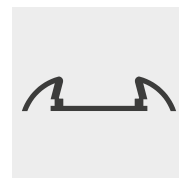

PO17 S. 104

max. 11 mm

ITEM NO. | ART. NR.

■ 2m 8103082

■ 3m 8103182

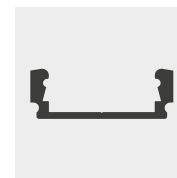

PL1 S. 38

max. 12 mm

ITEM NO. | ART. NR.

■ 2m 8106012

■ 3m 8106019

□ 2m 8106013

■ 2m 8106014

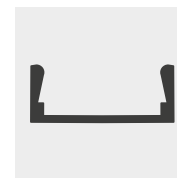

PK1 S. 370

max. 12 mm

ITEM NO. | ART. NR.

■ 2m 8201025

□ 2m 8201027

■ 2m 8201026

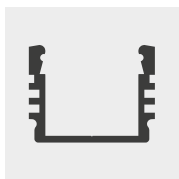

PL2 S. 42

max. 12 mm

ITEM NO. | ART. NR.

■ 2m 8106022

■ 3m 8106029

□ 2m 8106023

■ 2m 8106024

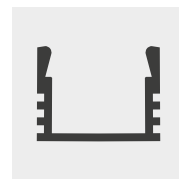

PK2 S. 374

max. 12 mm

ITEM NO. | ART. NR.

■ 2m 8201028

□ 2m 8201030

■ 2m 8201029

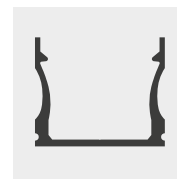

NL15 S. 304

max. 12 mm

ITEM NO. | ART. NR.

■ 2m 8121100

■ 3m 8121102

□ 2m 8121110

□ 3m 8121112

■ 2m 8121120

■ 3m 8121122

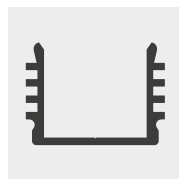

PL5 S. 54

max. 12 mm

ITEM NO. | ART. NR.

■ 2m 8105201

□ 2m 8105203

■ 2m 8105204

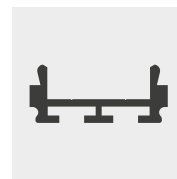

PL6 S. 60

max. 12 mm

ITEM NO. | ART. NR.

■ 2m 8106062



PO14 S. 92

max. 12 mm

ITEM NO. | ART. NR.

PO14 8600045

■ PN33 8105050

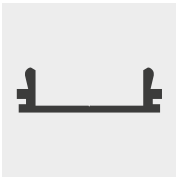

PO15 S. 96

max. 12 mm

ITEM NO. | ART. NR.

- 2m 8102062
- 3m 8102162

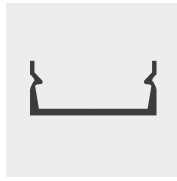

NL8 S. 296

max. 14 mm

ITEM NO. | ART. NR.

- 2m 8121000
- 2.5m 8121001
- 3m 8121002
- 2m 8121010
- 3m 8121012
- 2m 8121020
- 3m 8121022

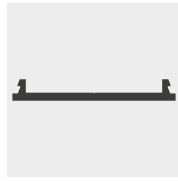

PO13 S. 88

max. 15 mm

ITEM NO. | ART. NR.

- 2m 8101030

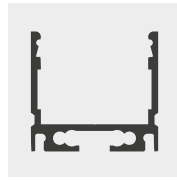

PN8 S. 144

max. 16 mm

ITEM NO. | ART. NR.

- 2m 8101020
- 2m 8101021
- 2m 8101022

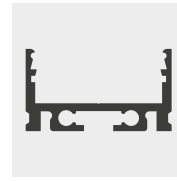

PN20V2 S. 174

max. 20 mm

ITEM NO. | ART. NR.

- 2m 8102210

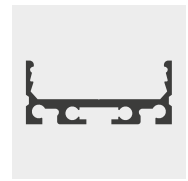

PN4 S. 120

max. 20 mm

ITEM NO. | ART. NR.

- 2m 8201012
- 3m 8201010
- 2m 8201013
- 2m 8201014

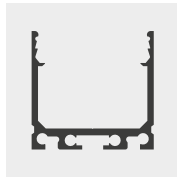

PN6V2 S. 132

max. 20 mm

ITEM NO. | ART. NR.

- 2m 8301017
- 2m 8301018
- 2m 8301019

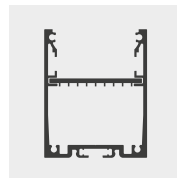

PN17V1 S. 152

max. 30 mm

ITEM NO. | ART. NR.

- 2m 8104020
- 3m 8123337
- 2m 8104022
- 3m 8123339
- 2m 8104024
- 3m 8123338

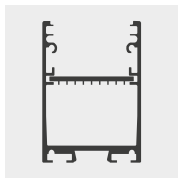

PN17V2 S. 158

max. 12mm | max. 30 mm

ITEM NO. | ART. NR.

- 2m 8123363
- 3m 8123366
- 2m 8123365
- 3m 8123368
- 2m 8123364
- 3m 8123367

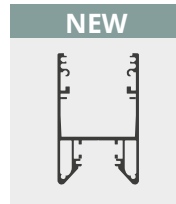

PN27 S. 164

max. 12mm | max. 30 mm

ITEM NO. | ART. NR.

CLICKABLE COOLING STRIPS |
KLICKBARER KÜHLSTREIFEN

- 2m 8192289
- 3m 8192291
- 2m 8192288
- 3m 8192293
- 2m 8192290
- 3m 8192292

SLIDABLE COOLING STRIP |
SCHIEBBARER KÜHLSTREIFEN

- 2m 8192295
- 3m 8192297
- 2m 8192294
- 3m 8192299
- 2m 8192296
- 3m 8192298



TILE | FLIESEN

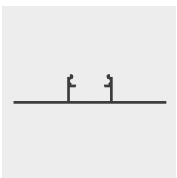

FP1 S. 186

max. 12 mm

ITEM NO. | ART. NR.

- 2m 8102032
- 2.5m 8102033
- 3m 8102132

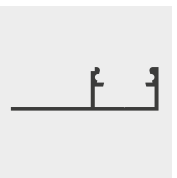

FP2 S. 190

max. 12 mm

ITEM NO. | ART. NR.

- 2m 8102034
- 2.5m 8102035
- 3m 8102134

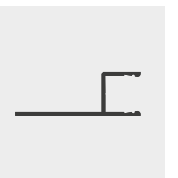

FP3 S. 194

max. 8 mm

ITEM NO. | ART. NR.

- 2m 8123174
- 2.5m 8123175
- 3m 8123210
- 2m 8123322

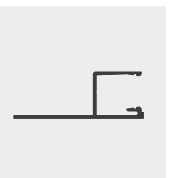

FP4 S. 198

max. 10 mm

ITEM NO. | ART. NR.

- 2m 8123176
- 2.5m 8123177
- 3m 8123220
- 2m 8123320
- 3m 8123321

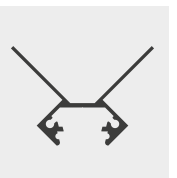

FP5 S. 202

max. 12 mm

ITEM NO. | ART. NR.

- 2m 8102036
- 2.5m 8102037
- 3m 8102136

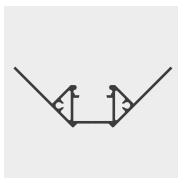

FP8V2 S. 206

max. 12 mm

ITEM NO. | ART. NR.

- 2m 8102230
- 2.5m 8102231
- 3m 8102232

RECESSED | EINBAU

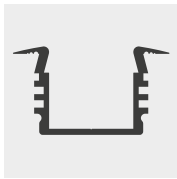

PL3 S. 46

max. 12 mm

ITEM NO. | ART. NR.

■ 2m 8106032

□ 2m 8106034

■ 2m 8106033

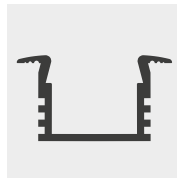

PK3 S. 378

max. 12 mm

ITEM NO. | ART. NR.

■ 2m 8201032

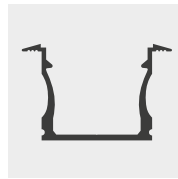

NL15F S. 308

max. 12 mm

ITEM NO. | ART. NR.

■ 2m 8121300

□ 3m 8121302

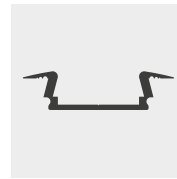

PL8 S. 66

max. 12 mm

ITEM NO. | ART. NR.

■ 2m 8106082

■ 3m 8106182

□ 2m 8106088

■ 2m 8106089

■ 3m 8106189

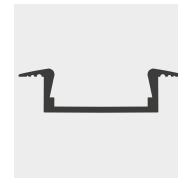

PK8 S. 382

max. 12 mm

ITEM NO. | ART. NR.

■ 2m 8201031

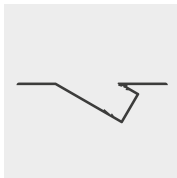

PI3V2 S. 210

max. 13 mm

ITEM NO. | ART. NR.

■ 2m 8108001

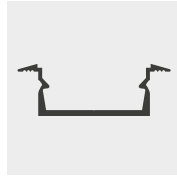

NL8F S. 300

max. 19 mm

ITEM NO. | ART. NR.

■ 2m 8121200

■ 3m 8121202

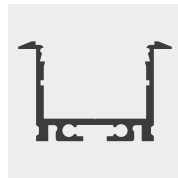

PN21 S. 178

max. 20 mm

ITEM NO. | ART. NR.

■ 2m 8102011

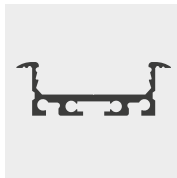

PN5 S. 126

max. 20 mm

ITEM NO. | ART. NR.

■ 2m 8206012

□ 2m 8206014

■ 2m 8206013

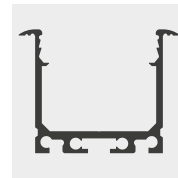

PN7V2 S. 138

max. 20 mm

ITEM NO. | ART. NR.

■ 2m 8305015

□ 2m 8305016

■ 2m 8305017

LUMINAIR | LEUCHTEN

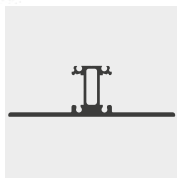

PL13 S. 80

max. 12 mm

ITEM NO. | ART. NR.

■ 2m 8101004

□ 2m 8101003

■ 2m 8101002

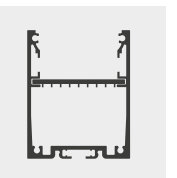

PN17 S. 152

max. 30 mm

ITEM NO. | ART. NR.

■ 2m 8104020

□ 2m 8104022

■ 2m 8104024

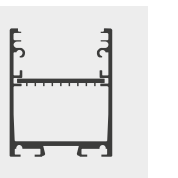

PN17V2 S. 158

max. 30 mm |
max. 12 mm

ITEM NO. | ART. NR.

■ 2m 8123363

■ 3m 8123366

□ 2m 8123365

□ 3m 8123368

■ 2m 8123364

■ 3m 8123367

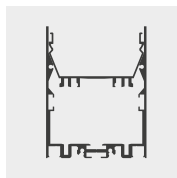

LL2 S. 278

max. 40 mm |
max. 5 mm

ITEM NO. | ART. NR.

■ 2m 8107110

■ 3m 8107216

□ 2m 8107112

□ 3m 8107218

■ 2m 8107111

■ 3m 8107217

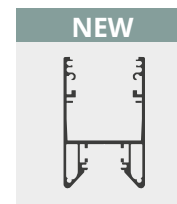

PN27 S. 164

max. 12 mm | max. 30 mm

ITEM NO. | ART. NR.

CLICKABLE COOLING STRIPS |
KLIICKBARER KÜHLSTREIFEN

■ 2m 8192289

■ 3m 8192291

□ 2m 8192288

□ 3m 8192293

■ 2m 8192290

■ 3m 8192292

SLIDABLE COOLING STRIP |
SCHIEBBARER KÜHLSTREIFEN

■ 2m 8192295

■ 3m 8192297

□ 2m 8192294

□ 3m 8192299

■ 2m 8192296

■ 3m 8192298

CORNER | ECK

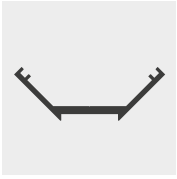

NL10 S. 312

max. 10 mm

ITEM NO. | ART. NR.

2m 8121400
3m 8121402

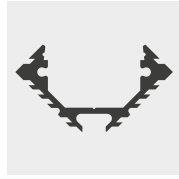

PL11 S. 76

max. 12 mm

ITEM NO. | ART. NR.

2m 8108012

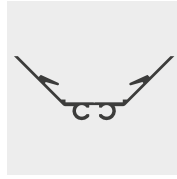

PO5 S. 84

max. 12 mm

ITEM NO. | ART. NR.

2m 8123100



PN10 S. 148

max. 13 mm

ITEM NO. | ART. NR.

PN10
2m 8600043
2,6m 8600044
PN33 8105050

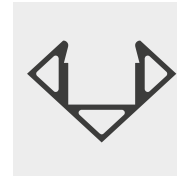

PO23 S. 112

max. 11 mm

ITEM NO. | ART. NR.

2m 8104052
2m 8104053
2m 8104054

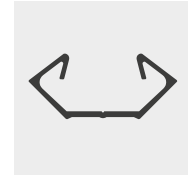

PO23V2 S. 116

max. 11 mm

ITEM NO. | ART. NR.

2m 8104060
3m 8104061
2m 8104062
2m 8104064

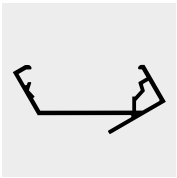

WP1 S. 366

max. 18 mm

ITEM NO. | ART. NR.

2m 8102085
2m 8102084

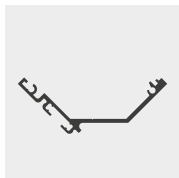

PN19V3 S. 170

max. 20 mm

ITEM NO. | ART. NR.

2m 8123359

INDIRECT | INDIREKT

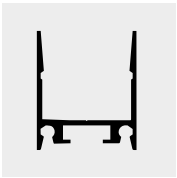

VA1 S. 316

max. 16 mm

ITEM NO. | ART. NR.

2m 8123151
2m 8123153
2m 8123152

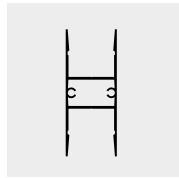

VA2 S. 320

max. 16 mm

ITEM NO. | ART. NR.

2m 8123154
2m 8123156
2m 8123155

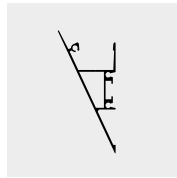

VA3 S. 324

max. 16 mm

ITEM NO. | ART. NR.

2m 8123157
2m 8123159
2m 8123158

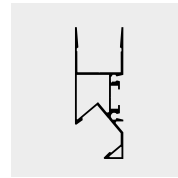

VA4 S. 328

max. 14/16 mm

ITEM NO. | ART. NR.

2m 8123160
2m 8123162
2m 8123161

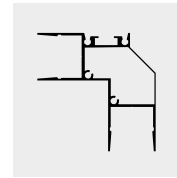

VA5 S. 332

max. 16 mm

ITEM NO. | ART. NR.

2m 8123163
2m 8123165
2m 8123164

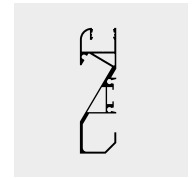

VA6 S. 336

max. 12/14 mm

ITEM NO. | ART. NR.

2m 8123166
2m 8123167

DRYWALL | TROCKENBAU

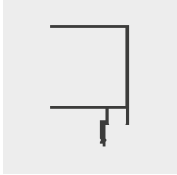

TBP1

S. 214

max. 6 mm

ITEM NO. | ART. NR.

- 2m 8102050
- 2m 8102056

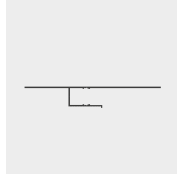

TBP2

S. 218

max. 11 mm

ITEM NO. | ART. NR.

- 2m 8102040
- 3m 8102140
- 2m 8103040
- 3m 8103140

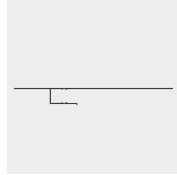

TBP2.1

S. 218

max. 11 mm

ITEM NO. | ART. NR.

- 2m 8102041
- 2m 8103041

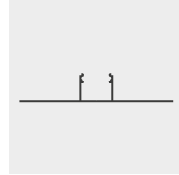

TBP3

S. 224

max. 14 mm

ITEM NO. | ART. NR.

- 2m 8102051
- 3m 8102151

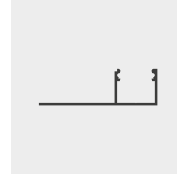

TBP4

S. 228

max. 14 mm

ITEM NO. | ART. NR.

- 2m 8102042
- 3m 8102142

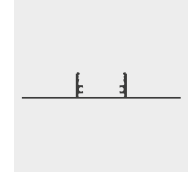

TBP5

S. 232

max. 20 mm

ITEM NO. | ART. NR.

- 2m 8102043
- 3m 8102143

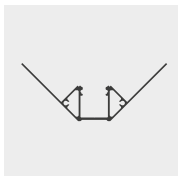

TBP6

S. 238

max. 14 mm

ITEM NO. | ART. NR.

- 2m 8102044
- 3m 8102144

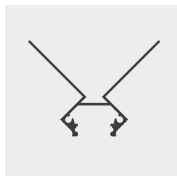

TBP7

S. 242

max. 12 mm

ITEM NO. | ART. NR.

- 2m 8102045
- 3m 8102145

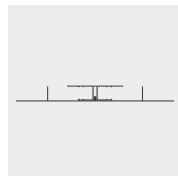

TBP10

S. 246

max. 11 mm

ITEM NO. | ART. NR.

- TBP10**
- 2m 8102047
- TBP8**
- 2m 8102046

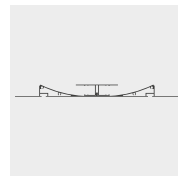

TBP11

S. 250

max. 11 mm

ITEM NO. | ART. NR.

- TBP11**
- 2m 8102048
- 2m 8103048
- 2m 8102054
- TBP8**
- 2m 8102046
- 2m 8103046
- 2m 8102052

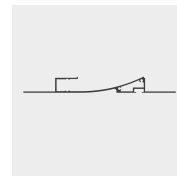

TBP12

S. 254

max. 11 mm

ITEM NO. | ART. NR.

- 2m 8102049
- 2m 8103049
- 2m 8102055

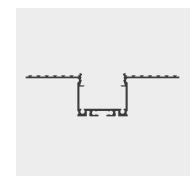

TBP13

S. 258

max. 21 mm

ITEM NO. | ART. NR.

- 2m 8103090
- 3m 8103190

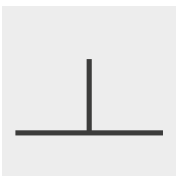

TBP14

S. 262

max. 12 mm

ITEM NO. | ART. NR.

- 2m 8102088
- 2m 8102089

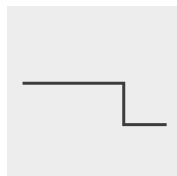

TBP16

S. 266

max. 12 mm

ITEM NO. | ART. NR.

- 2m 8102090
- 2m 8102091

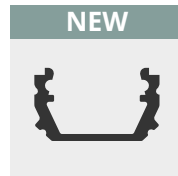

RP

S. 270

max. 10 mm

ITEM NO. | ART. NR.

- RP1 - Single
- 1m 8123579
- 2m 8123548
- RP2 - Double
- 1m 8123580
- 2m 8123549

SPECIAL | SPEZIAL

Stairs Treppen

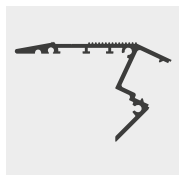

SP1 S. 284

max. 13 mm

ITEM NO. | ART. NR.
■ 2m 8122100

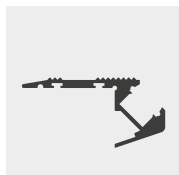

SP2 S. 288

max. 12 mm

ITEM NO. | ART. NR.
■ 2m 8102092

Cooling Strips Kühlstreifen



PN33 S. 182

max. 14 mm

ITEM NO. | ART. NR.
■ 2m 8105050

Outdoor Außenbereich



PA1 S. 414

OEM

ITEM NO. | ART. NR.
■ 1m 8106501
■ 6m 8106503

Furniture installation Möbeleinbau



MP1 S. 340

max. 6 mm

ITEM NO. | ART. NR.
■ 2m 8123168
□ 2m 8123170
■ 2m 8123169



MP2 S. 344

max. 6 mm

ITEM NO. | ART. NR.
■ 2m 8123171
□ 2m 8123173
■ 2m 8123172

Furniture installation Möbeleinbau

NEW



MP3 S. 348

max. 10 mm

ITEM NO. | ART. NR.
□ 2m 8123545
■ 2m 8123544

NEW

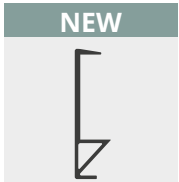

MP4 S. 352

max. 10 mm

ITEM NO. | ART. NR.
□ 2m 8123547
■ 2m 8123546

Walkable Begehbar

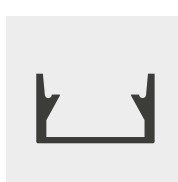

BP2 S. 356

max. 12 mm

ITEM NO. | ART. NR.
■ 2m 8102083

Drivable Befahrbar

NEW

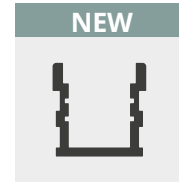

PA3 S. 360

max. 16 mm

ITEM NO. | ART. NR.
■ 2m 8123598

Silicone Silikon



SR1 S. 274

max. 10mm

ITEM NO. | ART. NR.
□ 5m 8123426
□ 20m 8123427
■ 5m 8123424
■ 20m 8123425



SR2 S. 274

max. 15 mm

ITEM NO. | ART. NR.
□ 5m 8123430
□ 20m 8123431
■ 5m 8123428
■ 20m 8123429

Clamping system Spannsystem



SF1 S. 292

max. 15 mm

ITEM NO. | ART. NR.
□ 10m 8123398
□ 20m 8123400
■ 10m 8123399
■ 20m 8123432

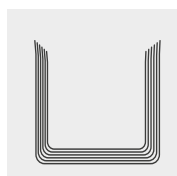

SV S. 404

max. 4 - 16 mm

ITEM NO. | ART. NR.
SV1 1m 8123441
SV2 1m 8123442
SV3 1m 8123443
SV4 1m 8123444



CURTAINS | GARDINEN

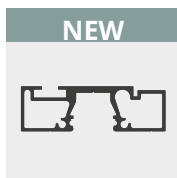

NEW

VP1 S. 386

max. 10 mm

ITEM NO. | ART. NR.

2m 8123539

2m 8123538

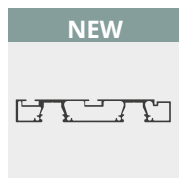

NEW

VP2 S. 390

max. 10 mm

ITEM NO. | ART. NR.

2m 8123541

2m 8123540

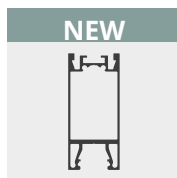

NEW

VP3 S. 394

max. 10 mm

ITEM NO. | ART. NR.

2m 8123559

2m 8123558



NEW

VP5 S. 398

max. 10 mm

ITEM NO. | ART. NR.

2m 8123574

2m 8123573



TRACK SYSTEM | STROMSCHIENEN

3-Phase
3-Phasen

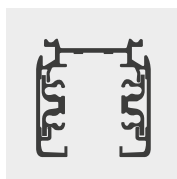

GP20 S. 420

ITEM NO. | ART. NR.

2m 8001624

3m 8001638

2m 8001623

3m 8001637

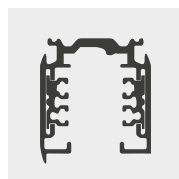

DP10 S. 426

ITEM NO. | ART. NR.

2m 8001639

3m 8001641

2m 8001640

3m 8001642

48V DC

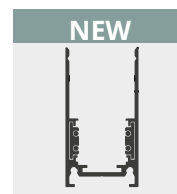

NEW

TS1 S. 434

ITEM NO. | ART. NR.

2m 8123492

3m 8123533

2m 8123457

3m 8123532

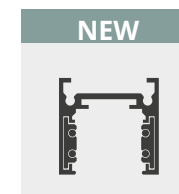

NEW

TS2 S. 435

ITEM NO. | ART. NR.

2m 8123493

3m 8123531

2m 8123458

3m 8123530

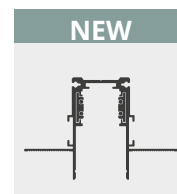

NEW

TS3 S. 436

ITEM NO. | ART. NR.

2m 8123494

2m 8123459

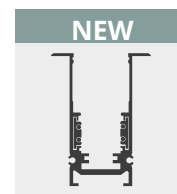

NEW

TS4 S. 437

ITEM NO. | ART. NR.

2m 8123495

2m 8123460



REFERENCE GALLERY

PROJECTS THAT HAVE PROFILE

Discover our products in action!

Take a look at our reference gallery and see the exciting projects we have already been able to realise.



REFERENZGALERIE

PROJEKTE, DIE PROFIL HABEN

Unsere Produkte im Einsatz entdecken!

Werfen Sie einen Blick in unsere Referenzgalerie und sehen Sie, welche spannenden Projekte wir bereits verwirklichen durften.



COVERS | ABDECKUNGEN

- Material: Polycarbonate
- Classification flammability UL94 V-2 (hardly inflammable)

Classification flammability UL94 V-2: Extinguishing of a vertically clamped sample within 30 seconds

- Material: Polycarbonat
- Klassifizierung Brennbarkeit: UL94 V-2 (schwer brennbar)

Klassifizierung Brennbarkeit UL94 V-2: Verlöschen einer vertikal eingespannten Probe innerhalb von 30 Sekunden

OPAL SATINISED OPAL SATINIERT

65 %

Light transmission
Lichtdurchlässigkeit

OPALPLUS OPALPLUS

80 %

Light transmission
Lichtdurchlässigkeit

FROSTED GEFROSTET

75 %

Light transmission
Lichtdurchlässigkeit

SR1 & SR2 OPAL

45 %

Light transmission
Lichtdurchlässigkeit

WHITE MATT SANBLASTED | WEISS MATT SANDGESTRAHLT

matt | 75 %

Light transmission
Lichtdurchlässigkeit

CLEAR | KLAR

85 %

Light transmission
Lichtdurchlässigkeit

BLACK | SCHWARZ

matt | 25 %

Light transmission
Lichtdurchlässigkeit

SR1 & SR2 BLACK | SCHWARZ

5 %

Light transmission
Lichtdurchlässigkeit

OPALPLUS
OPALPLUS
80 %

CLEAR
KLAR
85 %

OPAL SATINISED
OPAL SATINIERT
65 %



WHITE MATT
WEISS MATT
75 %

FROSTED
GEFROSTET
75 %

BLACK MATT
SCHWARZ MATT
25 %

Protective cover | Schutzcover



C1S soft

ITEM NO. | ART. NR.

5m 8600065

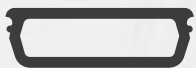

C10S soft

ITEM NO. | ART. NR.

5m 8600066

The protective covers C1S and C10S soft are clicked into the aluminium profile for protection after the installation of drywall and tile profiles. The high-quality soft PVC is very robust and withstands the pressure of filling/plastering or painting. The protective cover prevents putty, glue, sealing material, silicone or paint from penetrating into the interior. Then the protective cover is removed, cleaned and is reusable several times over. Finally, the cover (PC) can be inserted into the profile.

Die Schutzcover C1S und C10S soft werden nach der Montage von Trockenbau- und Fliesenprofilen in das Alu-Profil zum Schutz eingeklickt. Das hochwertige Soft-PVC ist sehr robust und hält dem Druck beim Verspachteln/-putzen oder Streichen stand. Das Schutzcover verhindert, dass Spachtelmasse, Kleber, Dichtmaterial, Silikon oder Farbe in den Innenraum eindringt. Danach wird das Schutzcover abgenommen, gereinigt und ist vielfach wiederverwendbar. Abschließend kann die Abdeckung (PC) in das Profil eingesetzt werden.



C1 65 %

2m 8600004
2.5m 8600026
3m 8600080
6m 8600037



C2 85 %

2m 8600003
2.5m 8600135
3m 8600136

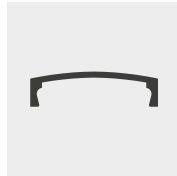

C3 65 %

2m 8600005
3m 8600027
6m 8600038



C4 65 %

2m 8600006

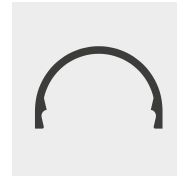

C5 65 %

2m 8600007

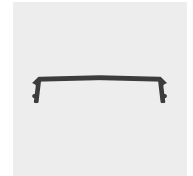

C7 65 %

2m 8600009



C8 65 %

2m 8600013
3m 8600028
6m 8600056



C9 85 %

2m 8600012

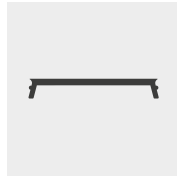

C10 65 %

2m 8600017
6m 8600040

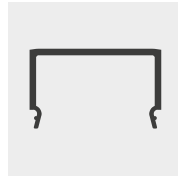

C11 65 %

2m 8600018
3m 8600134

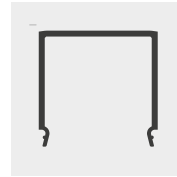

C12 65 %

2m 8600019



C13 65 %

2m 8600020

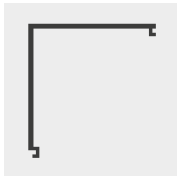

C16 65 %

2m 8600023

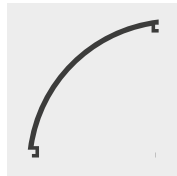

C17 65 %

2m 8600024

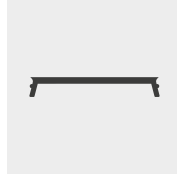

C18 85 %

2m 8600035



C19 75 %

2m 8600036



C20 65 %

2m 8600048
6m 8600049

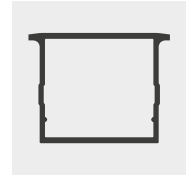

C21 65 %

2m 8600050
2.6m 8600051



C22 65 %

2m 8600054
6m 8600055



C23 65 %

2m 8600046
3m 8600116
6m 8600047

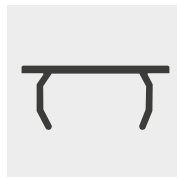

C24 65 %

2m 8600106
6m 8600107



C26 65 %

2m 8600111
6m 8600112

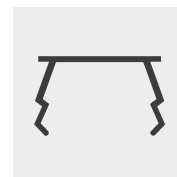

C27 65 %

2m 8600084
3m 8600113

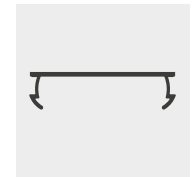

C29 65 %

2m 8600059
3m 8123557



C30 65 %

2m 8600077
3m 8600081

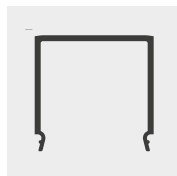

C31 85 %

2m 8600068



C32 25 %

2m 8600070
3m 8600103
6m 8600071



C33 25 %

2m 8600072
6m 8600073



C34 25 %

2m 8600074
6m 8600075

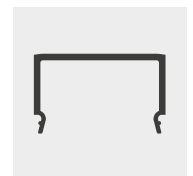

C35 85 %

2m 8600063



C36 75 %
2m 8600078

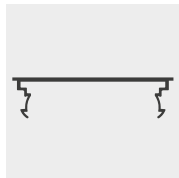

C38 75 %
2m 8600082

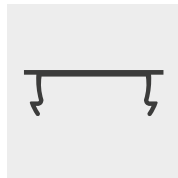

C40 65 %
2m 8600085
2.5m 8600086
3m 8600087

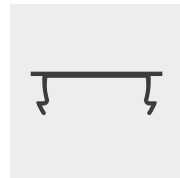

C41 85 %
2m 8600088
3m 8600089

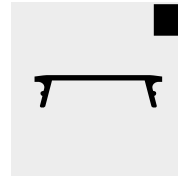

C42 25 %
2m 8600092

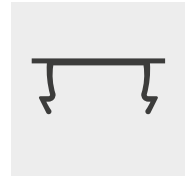

C43 65 %
2m 8600093
3m 8600114

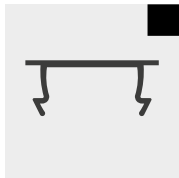

C44 25 %
2m 8600094
3m 8600115

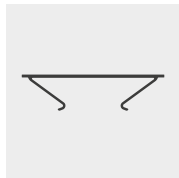

C45 65 %
2m 8600097

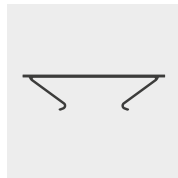

C46 75 %
2m 8600098

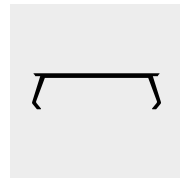

C47 75 %
2m 8600099

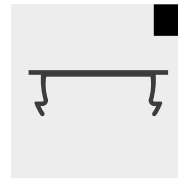

C48 25 %
2m 8600100
3m 8600108

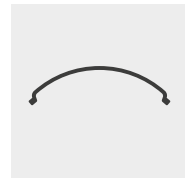

C49 65 %
2m 8600101
3m 8600102

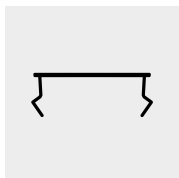

C50 65 %
2m 8600104

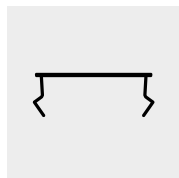

C51 85 %
2m 8600105



C52 25 %
2m 8600109
6m 8600110

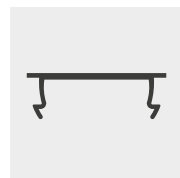

C53 75 %
2m 8600155
3m 8600117

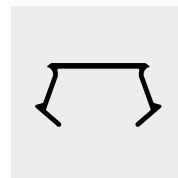

C54 65 %
2m 8600119
3m 8600121

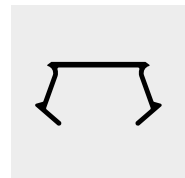

C55 85 %
2m 8600120

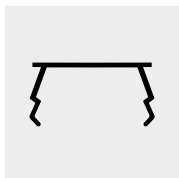

C56 65 %
2m 8600133



C57 65 %
2m 8600137



C58 75 %
2m 8600154

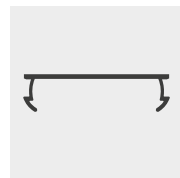

C61 80 %
2m 8123342
3m 8506151

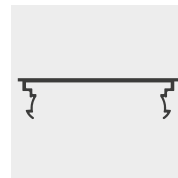

C62 80 %
2m 8123343
3m 8506152

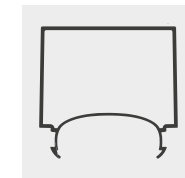

C63 65 %
2m 8123340
3m 8123341



C64 75 %
2m 8123374

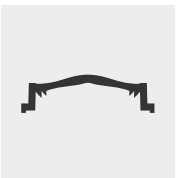

C65
117,6 cm 8123385

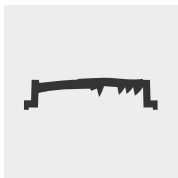

C66
117,6 cm 8123384

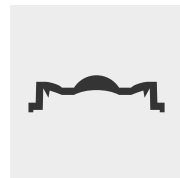

C67
117,6 cm 8123383

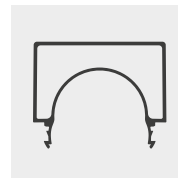

C68 65 %
2m 8123571
3m 8123572



**INCLUDED IN THE PA3 SET
IM SET MIT PA3 ENTHALTEN**
65 %

Homogeneous light with perfect light lines

BY GALAXY® PROFILES

Guaranteed product quality at the best price-performance ratio
Garantierte Produktqualität | Ausgezeichnetes Preis-/Leistungsverhältnis

Intelligent product design and unique product compatibility
Intelligentes Produktdesign | Einzigartige Produktkompatibilität

Sustainable product availability | Many years of experience and know-how
Nachhaltige Produktverfügbarkeit | Langjährige Erfahrung und Know-how

First-class comprehensive and personal service
Kompetente/Zuverlässige Fachberatung | Full-Service und persönlicher Support

OEM production – customised profiles up to 6 m length
Kundenspezifische Konfektionierung | OEM Fertigung bis 6 m Länge

Sample box

In this sample box you will find 50 mm long hand samples of all LED profile series incl. the polycarbonate covers.

- Surface profiles
- Recessed profiles
- Corner profiles
- Drywall profiles
- Luminair profiles
- Tile profiles
- Profiles for indirect lighting
- Curtain profiles
- Special profiles
- Covers

Musterbox

In dieser Musterbox finden Sie 50 mm lange Handmuster aller LED Profilserien inkl. der Polycarbonat-Abdeckungen.

- Aufbauprofile
- Einbauprofile
- Eckprofile
- Trockenbauprofile
- Leuchtenprofile
- Fliesenprofile
- Profile für indirekte Beleuchtung
- Gardinenprofile
- Spezialprofile
- Abdeckungen

Musterbox | Sample box
8192345



Hand sample

In addition to our sample box, which contains all profiles, you can also obtain each sample with a length of 50 mm individually if required.

Handmuster

Neben unserer Musterbox, in der alle Profile enthalten sind, erhalten Sie jedes Muster mit einer Länge von 50 mm bei Bedarf auch einzeln.

Request now! | Jetzt Anfordern!

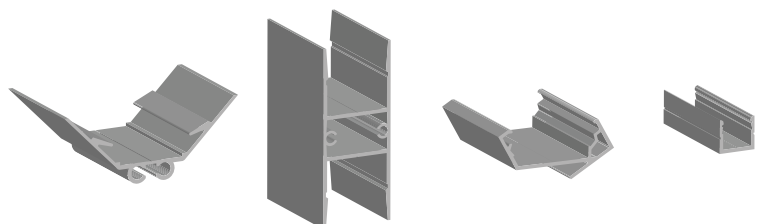



GALAXY[®] profiles

Perfect Light Lines

About us

We are an Austrian company with many years experience in lighting design. We develop, design and produce high-quality aluminium profile systems for LED lighting concepts (indoor and outdoor).

Perfect lighting conditions by GALAXY[®] profiles

Our profile systems are design-protected and produced from top quality raw materials on modern, fully automated, precision equipment to meet the strictest quality criteria. The aluminium components are subjected to a refining process. In this process they are hardened, freed from impurities and inclusions, sealed, and given multi-year protection from atmospheric effects.

The particular properties of the fracture-resistant, non-flammable polycarbonate profile covers reduce light and power losses to a minimum and prevent physical as well as psychological light exposure. The product designers at GALAXY[®] profiles attach particular importance to sophisticated functionality in a timeless aesthetic.

Über uns

Wir sind ein österreichisches Unternehmen mit Sitz in Kufstein und besitzen langjährige Erfahrung im Lichtdesign. Wir entwickeln, designen und produzieren hochwertige Alu-Profilsysteme für LED-Beleuchtungskonzepte (In- und Outdoor).

Perfekte Lichtverhältnisse mit GALAXY[®] profiles

Unsere Profilsysteme sind designgeschützt und werden auf modernen, vollautomatischen Präzisionsanlagen aus Rohstoffen bester Güteklasse nach strengsten Qualitätskriterien hergestellt. Die Aluminiumkomponenten werden veredelt. Damit sind sie gehärtet, frei von Verunreinigungen und Einschlüssen, versiegelt und über viele Jahre vor atmosphärischen Einwirkungen geschützt.

Die besonderen Eigenschaften der bruchsicheren und nicht brennbaren Profilabdeckungen aus Polycarbonat reduzieren Licht- und Leistungsverluste auf ein Minimum und beugen physischer sowie psychischer Lichtbelastung vor. Die Produktdesigner bei GALAXY[®] profiles legen besonderen Wert auf raffinierte Funktionalität in zeitloser Ästhetik.

Design Diversity

We supply wholesalers and retailers, industry, and commercial end-users with off-the-shelf standard profile systems worldwide. Due to high product availability, these profile systems can be supplied quickly and distinguish themselves through their

- perfect light lines for homogeneous light quality,
- guaranteed product quality at the best price-performance ratio,
- intelligent product design and unique product compatibility,
- unlimited variety of designs, and
- simple and materials-saving installation.

On the basis of an appropriate minimum quantity, we offer our customers off-the-shelf, custom-built, tailored aluminium profile systems.

As part of this service, our product managers and designers are happy to undertake the product development and to design profile systems for every conceivable requirement in close cooperation with you.

From choosing the right raw material through to packaging and logistics. We meet all our customers' requirements.

Competent specialist advice and a first-class comprehensive service!

Designvielfalt

Wir beliefern weltweit den Groß- und Fachhandel, die Industrie sowie gewerbliche Endabnehmer mit seriengefertigten Standard-Profilsystemen. Diese Profilsysteme sind aufgrund hoher Produktverfügbarkeit in kurzer Zeit lieferbar und überzeugen mit

- perfekten Lichtlinien für homogene Lichtqualität,
- garantierte Produktqualität zum besten Preis-/Leistungsverhältnis,
- intelligentem Produktdesign und einzigartiger Produktkompatibilität,
- grenzenlose Designvielfalt sowie
- einfacher und substanzschonender Montage.

Ab einer entsprechenden Mindestmenge bieten wir unseren Kunden die serienmäßige Sonderanfertigung individueller Profilsysteme aus Aluminium.

Dabei übernehmen unsere Produktmanager und -Designer gern die Produktentwicklung und entwerfen in enger Zusammenarbeit mit Ihnen Profilsysteme für jede denkbare Anforderung.

Von der Wahl des richtigen Rohmaterials bis hin zur Verpackung und der Logistik. Wir erfüllen jeden Kundenwunsch.

Kompetente Fachberatung und erstklassiger Full-Service!



Perfect Light Lines

Intelligent product design and unique product compatibility are the basis for pioneering LED lighting concepts. LED profile systems from GALAXY® profiles are modular LED lighting solutions. The individual system components are quickly and easily assembled with little effort using the click system and mounted in a gentle manner.

Homogeneous lighting with perfect light lines from GALAXY® profiles

- Guaranteed product quality at the best price-performance ratio
- Intelligent product design with unique product compatibility
- An unlimited variety of designs and high product availability
- Many years of experience and know-how
- Competent specialist advice and a first-class comprehensive service

Intelligentes Produktdesign und einzigartige Produktkompatibilität sind die Grundlage für zukunftsweisende LED Beleuchtungskonzepte. LED Profilsysteme von GALAXY® profiles sind modulare LED Lichtlösungen. Die einzelnen Systemkomponenten werden mit wenig Aufwand, einfach und schnell per Klick-System zusammengesetzt und substanzschonend montiert.

Homogenes Licht mit perfekten Lichtlinien von GALAXY® profiles

- Garantierte Produktqualität zum besten Preis-/Leistungsverhältnis
- Intelligentes Produktdesign mit einzigartiger Produktkompatibilität
- Grenzenlose Designvielfalt und hohe Produktverfügbarkeit
- Langjährige Erfahrung und Know-how
- Kompetente Fachberatung und erstklassiger Full-Service



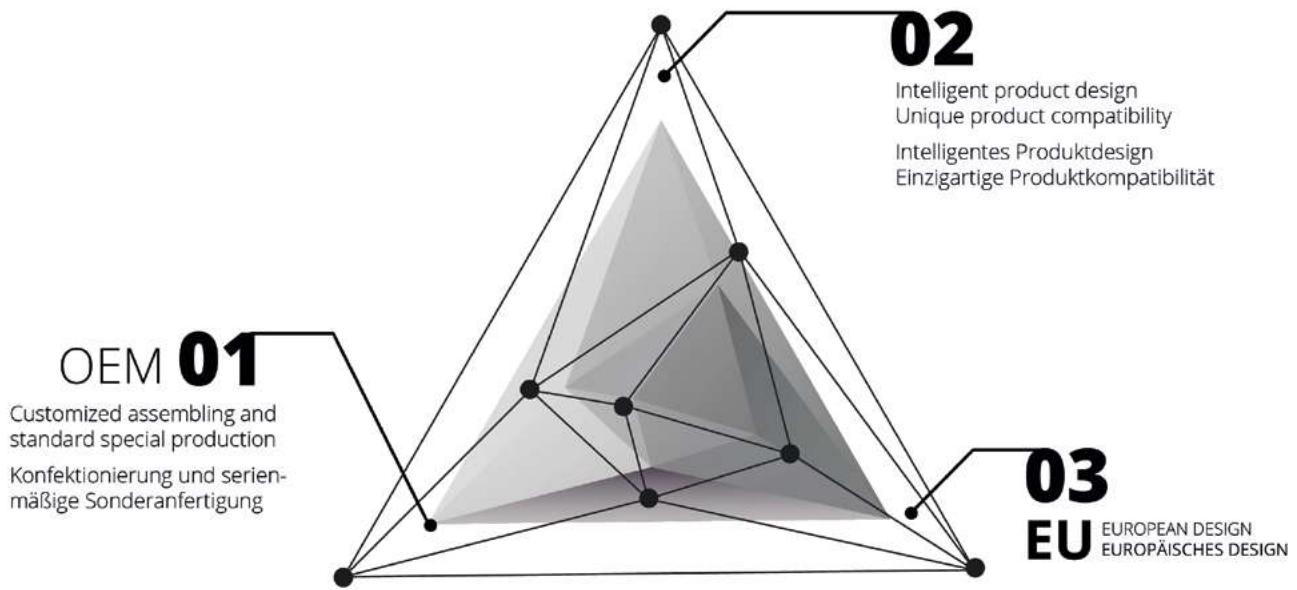

Customized assembling and standard special production (OEM)

With a minimum purchase quantity, the LED profiles as well as the plastic covers from our standard range are made to order or produced according to customer specified lengths of up to 6 m total length per LED profile system.

LED Aluminium profiles by GALAXY® profiles can be produced in all RAL-colours required (Powder coating).

We are looking forward to receiving your enquiries!

Konfektionierung und serienmäßige Sonderanfertigung (OEM)

Ab entsprechender Mindest-Abnahmemenge werden die LED Profile sowie Kunststoff-Abdeckungen aus unserem Standardsortiment nach Maß konfektioniert oder gemäß kundenspezifischen Längen-Vorgaben bis max. 6 m Gesamtlänge pro LED Profilsystem produziert.

Auf Wunsch können LED Aluminium-Profile von GALAXY® profiles in sämtlichen RAL-Farben hergestellt werden (Pulverbeschichtung).

Wir erwarten gern Ihre Anfragen!

Customer-Specific assembling

PROFESSIONAL | PRECISE | RELIABLE

Our service for you!

We finish LED aluminium profiles, covers and aluminium cool Strips. This services includes:

- Precise cutting to suit given measurements (also mitre cuts from 45° to 135°)
- Deburring cutting surfaces
- Drilling the LED profiles to specifications
- Clicking together the LED aluminium profiles and covers
- Slotting together the LED aluminium profile and the cable port (if compatible)
- Applying the end caps
- Threading the rope hangers
- And many additional services such as custom packaging and labelling.

We await your requests!

Kundenspezifische Konfektionierung

PROFESSIONELL | PRÄZISE | ZUVERLÄSSIG

Unser Service für Sie!

Wir konfektionieren LED Alu-Profile, Abdeckungen und Alu-Kühlstreifen. Dieser Service umfasst

- den präzisen Zuschnitt entsprechend den vorgegebenen Abmessungen (auch stufenlose Gehrungsschnitte von 45°-135°),
- das Entgraten der Schnittflächen,
- das Bohren der LED Alu-Profile nach Vorgabe,
- das Zusammenklicken der LED Alu-Profile und Abdeckungen,
- das Ineinanderstecken des LED Alu-Profils mit der Kabelschleuse (bei Kompatibilität),
- das Anbringen der Endkappen,
- das Einfädeln der Seilabhängung
- sowie viele zusätzliche Leistungen wie individuelle Verpackung und Etikettierung.

Wir erwarten gern Ihre Anfragen!



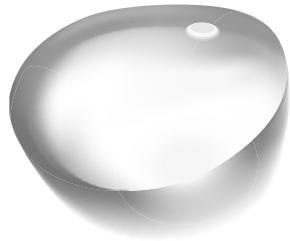

Use in wet rooms and outdoors

The use in wet areas or outdoors is possible only in sealed form. Silicone is applied to the connection joints for sealing which provides extra protection against moisture and water. In the LED profile systems, absolute tightness against water is achieved with the casting of Wepuran casting resin based on polyurethane resin (PUR).

IMPORTANT:

During the installation of LED profile systems in wet rooms and outdoors, it is imperative to pay attention to the exclusive use of LED flexstrips with the appropriate protection class! Linear LED outdoor lighting systems with GALAXY® profiles meet these requirements by default.

When choosing a LED flex strip, check the manufacturer's protection class (at least IP65).

We will be happy to advise you!

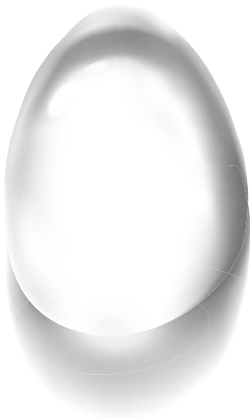

Einsatz in Nasszellen und Outdoor

Der Einsatz in Nasszellen oder im Außenbereich ist ausschließlich in abgedichteter Form möglich. Besonderen Schutz vor Feuchtigkeit und Wasser bietet Silikon, das zum Abdichten auf die Verbindungsstellen aufgetragen wird. Absolute Dichtheit gegen Wasser erreicht man bei den LED Profilsystemen durch Vergießen mit Wepuran-Gießharz auf Polyurethanharzbasis (PUR).

WICHTIG:

Bei der Montage von LED Profilsystemen in Nasszellen und Outdoor ist zwingend auf die ausschließliche Verwendung von LED Flexbändern mit entsprechender Schutzart zu achten! Lineare LED Outdoor Leuchtensysteme von GALAXY® profiles erfüllen diese Anforderungen standardmäßig.

Achten Sie bei der Wahl des LED Strips auf die herstellerseitig angegebene Schutzart (mindestens IP65).

Wir beraten Sie gerne!



Independent linear LED lighting systems

The profile is connected to the PL10 LED SURFACE profile/cable with a universal duct using a click system. The complete wiring is professionally and safely stored in the PL10 LED SURFACE profile/cable universal duct.

The end caps provided for this are made of aluminium and are secured with the supplied screws. Mounting springs (e.g. for fixing in plasterboards) available from GALAXY® profiles or screws are used to mount the linear LED lamp to the support or building fabric. With the corresponding wire suspension (sheathed cables with 150 cm length as well as a load capacity of 75 kg per cable), the LED lamp becomes a timeless, aesthetic and above all functional linear LED pendant lamp.

For demanding installation on sloped ceilings (ceiling canopy), the jointed gripper is used in addition to the wire suspension. (The individual components for the linear LED lamp systems can be found in the accessories of the respective profile series!)

Linear LED lighting systems from GALAXY® profiles are perfect LED lighting solutions that are particularly convincing with the high ecological and economic energy efficiency.

- The simple and easy installation,
- an integrative product design and

- the freely selectable properties of the LED flex Strips with respect to the lighting performance (watts), luminous flux (lumens), colour temperature (Kelvin), colour reproduction (CRI/Ra) offer virtually unlimited application possibilities.

These stand-alone linear LED lighting systems from GALAXY® profiles are fitted with the corresponding LED Strips as needed and can be used as

- general room lighting for residential, office, conference, meeting, presentation and working spaces (direct or indirect LED lighting),
- staging LED decorative lighting,
- atmospheric LED effect lighting or also for
- object-gentle LED shop, display / showcase lighting.

In the hotel and gastronomy business, linear LED lighting systems create a welcoming and pleasant atmosphere for the guests. In the work areas, foyers, corridors and technology/supply rooms, they offer the employees sufficient brightness for a safe and accident-free work.

Das Profil wird mit dem PL10 LED AUFBAU-Profil/Kabel-Universalkanal per Klicksystem verbunden. Die komplette Verkabelung wird professionell und sicher im PL10 LED AUFBAU-Profil/Kabel-Universalkanal verstaut.

Die hierfür vorgesehenen Endkappen sind aus Aluminium und werden mit den mitgelieferten Schrauben festgemacht. Die Lineare LED Leuchte wird mit bei GALAXY® profiles erhältlichen Montagefedern (z. B. zum Fixieren in Gipsplatten) oder mit Schrauben am Träger bzw. der Bausubstanz montiert. Mit entsprechender Seilabhängung (ummantelte Seile mit 150 cm Länge sowie einer Tragkraft von 75 kg pro Seil) wird die LED Leuchte zu einer zeitlosen, ästhetischen und vor allem funktionellen Linearen LED Hängeleuchte.

Für die anspruchsvolle Montage an schrägen Decken (Deckenbaldachin) wird ergänzend zur Seilabhängung der Gelenkgripper verwendet. (Die einzelnen Komponenten zu den Linearen LED Leuchtensystemen finden Sie im Zubehör der jeweiligen Profilerien!)

Lineare LED Leuchtensysteme von GALAXY® profiles sind perfekte LED Lichtlösungen, die besonders durch hohe ökologische und ökonomische Energieeffizienz überzeugen.

- Einfache und flexible Montage,
- sich integrierendes Produktdesign und

- die frei wählbaren Eigenschaften der LED Flexbänder hinsichtlich Lichtleistung (Watt), Lichtstrom (Lumen), Farbtemperatur (Kelvin), Farbwiedergabe (CRI/Ra) bieten nahezu unbegrenzte Einsatzmöglichkeiten.

Diese eigenständigen Linearen LED Leuchtensysteme von GALAXY® profiles werden je nach Anforderung mit den entsprechenden LED Strips bestückt und können als

- allgemeine Raumbelichtung für Wohn-, Büro-, Konferenz-, Besprechungs-, Präsentations- und Arbeitsräume (direkte oder indirekte LED Beleuchtung),
- inszenierende LED Dekorbeleuchtung,
- stimmunggebende LED Effektbeleuchtung oder auch für
- die objektschonende LED Shop-, Vitrinen-/Schaufensterbeleuchtung eingesetzt werden.

In Hotels und der Gastronomie schaffen Lineare LED Leuchtensysteme eine einladende, wohlige Atmosphäre für die Gäste. In den Arbeitsbereichen, Foyers, Fluren und Technik-/Versorgungsräumen bieten sie den Angestellten ausreichend Helligkeit für ein sicheres und unfallfreies Arbeiten.

Eigenständige Lineare LED Leuchtensysteme



Homogeneous lighting with perfect light lines

FROM GALAXY® PROFILES

LED profile systems and linear LED lamp systems from GALAXY® profiles are used both as general spatial and object lighting as well as decorative and effect lighting.

LED Profilsysteme und Lineare LED Leuchtensysteme von GALAXY® profiles werden sowohl als allgemeine Raum- und Objektbeleuchtung als auch als Dekor- und Effektbeleuchtung eingesetzt.

LED living space lighting

The light acts and makes a cosy home out of any living space!

LED Wohnraumbeleuchtung

Licht wirkt und macht aus jedem Wohn(t)raum ein trautes Zuhause!



LED decorative lighting

Functional and staging LED lighting integrated into residential and office furniture and home accessories for the kitchen, bathroom and living spaces!

LED Dekorbeleuchtung

Funktionelle und inszenierende LED Beleuchtung integriert in Wohn- und Büromöbel und Accessoires.



Hotel and gastronomy

Atmospheric LED lighting solutions invite you to linger!

Hotel und Gastronomie

Stimmungsgebende LED Lichtlösungen laden zum Bleiben ein!





Crafts and trades

Bright LED ambient lighting with LED lighting highlights for fatigue-free work!

Gewerbe und Handwerk

Helle LED Raumbeleuchtung mit LED Lichthighlights für ermüdungsfreies Arbeiten!



Retail trade

Inviting product presentation with object-friendly LED lighting!

Einzelhandel

Einladende Produktpräsentation mit objektschonender LED Beleuchtung!



LED office lighting

Indirect, glare-free LED lighting reduces the mental and physical light burden!

LED Bürobeleuchtung

Indirekte, blendfreie LED Beleuchtung reduziert die psychische und physische Lichtbelastung!



Façades

Creative LED lighting creates emotion and excites!

Fassaden

Kreative LED Beleuchtung schafft Emotion und begeistert!



Outdoor facilities

Building staging with professional LED architectural lighting!

Außenanlagen

Gebäudeinszenierung mit professioneller LED Architekturbeleuchtung!

CONCRETE INSERT PROFILE BETON-EINLEGEPROFIL

Compatible with | Kompatibel mit

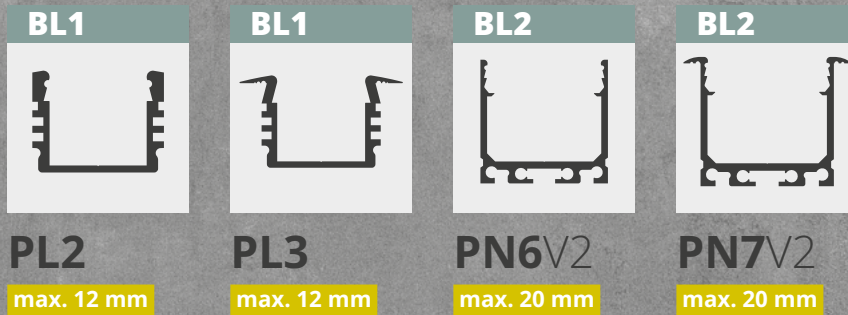

Watch the assembly instructions online now!

Jetzt die Montageanleitung Online finden!

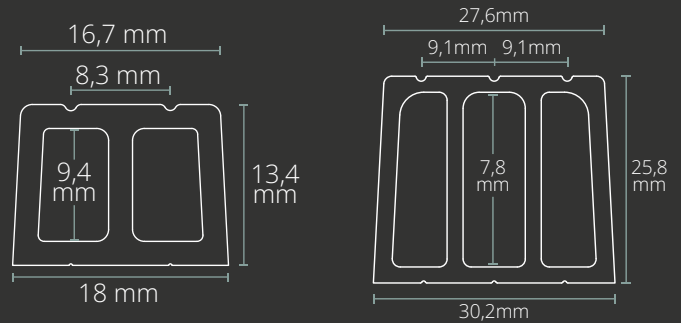

1 Drill hole for cable connection. | Loch für Kabelanschluss bohren.

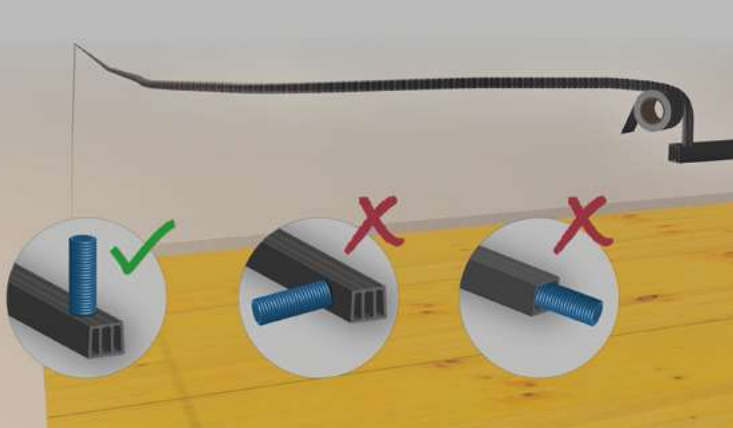

2 Place and pour concrete. | Platzieren und Betonieren.

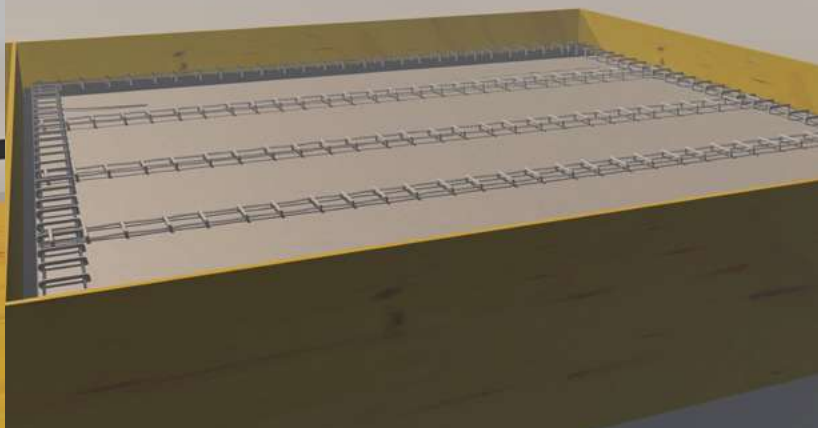

3 Remove formwork panels and concrete profile. | Schaltafeln und Betonprofil entfernen.



4 Glue in matching profile and connect flex stripe. | Passendes Profil einkleben und Flexband anschließen.

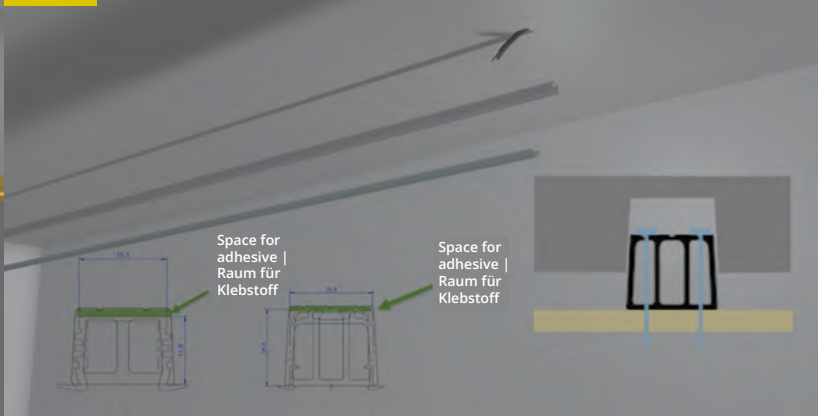

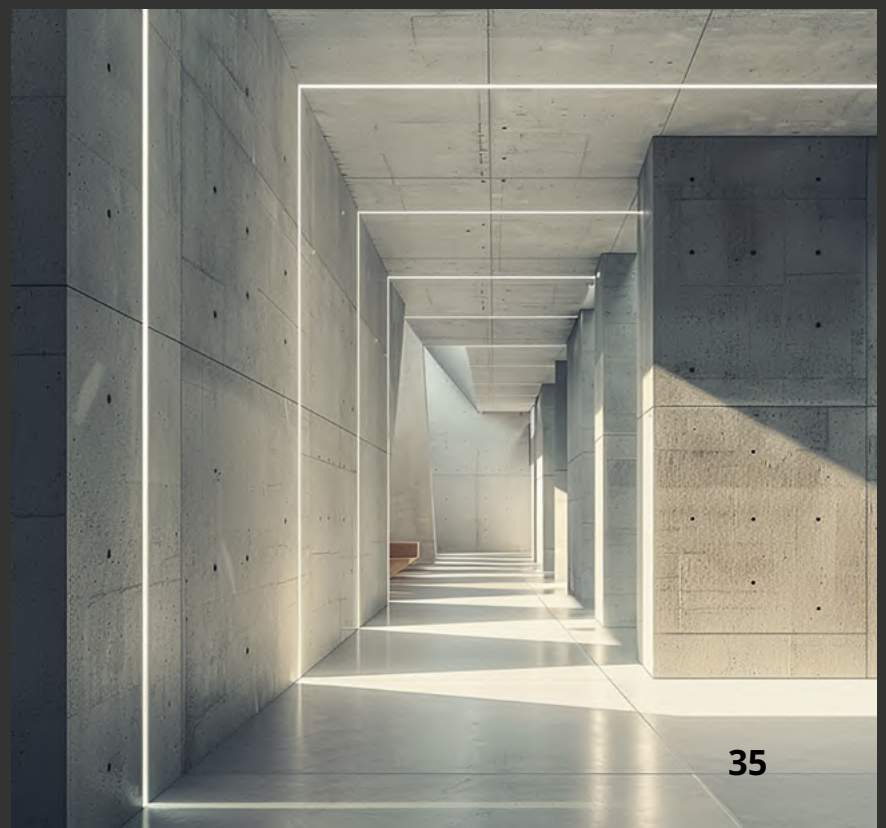
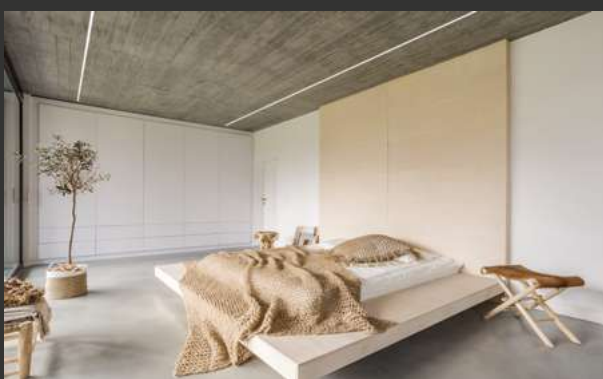





GALAXY[®] profiles

LED Profile Systems
LED Profil Systeme

PL1

SURFACE | AUFBAU

200 cm | 300 cm

max. 12 mm

OEM

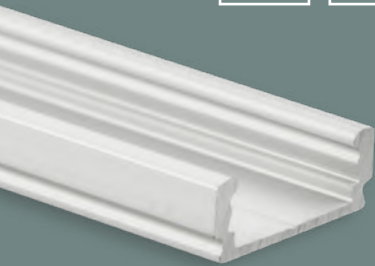

EXTENSION OF SERVICE LIFE
VERLÄNGERUNG LEBENSDAUER

MECHANICAL PROTECTION
MECHANISCHER SCHUTZ

COOLING
KÜHLUNG

HIGH LIGHT UTILISATION
HOHE LICHTVERWERTUNG

HOMOGENEOUS LIGHT
HOMOGENES LICHT

HOMOGENEOUS LIGHT with modular LED light solutions

- Wall, ceiling or floor mounting
Wand-, Decken- oder Bodenmontage
- Residential and office furniture
Wohn- und Büromöbel
- Furniture for business equipment
Möbel für Geschäftsausstattung
- Home accessories
Wohnaccessoires
- Mirrors | Spiegel
- Cabinet doors | Schranktüren
- Display cases | Vitrinen
- Shelves | Regale
- Stairs and railings
Treppenstufen und -Geländer
- Balustrades | Balustraden
- Façades, balconies and terraces
Fassaden, Balkone und Terrassen
- Living spaces | Wohnräume
- Offices | Büroräume
- Hotel and gastronomy business
Hotellerie und Gastronomie
- Retail (shop and showcase windows)
Einzelhandel (Shop- und Schaufenster)
- Business areas and showrooms
Geschäftsflächen und Showrooms
- Barber / Beauty / body art studios
Friseur-/Beauty-/Body-Art-Studios
- Halls, foyers and corridors
Hallen, Foyers und Flure
- Wellness and indoor leisure facilities
Wellness- und Indoor-Freizeitanlagen
- Wet rooms | Nasszellen

Mounting/installation on/in wood Strips and plates, plasterboard, tiles, stone, granite, marble and metal surfaces
Montage/Einbau auf/in Holzleisten und -platten, Gipsplatten, Fliesen, Stein-, Granit-, Marmor- und Metalloberflächen



PL1

SURFACE | AUFBAU

flat | flach | LED Strips max. 12 mm

Silver/Silber
ANODIZED | ELOXIERT

RAL 9010 White/Weiß
POWDER-COATED | PULVERBESCHICHTET

RAL 9005 Black/Schwarz
POWDER-COATED | PULVERBESCHICHTET



max. 12 mm

max.
12 mm



OEM



The PL1 LED SURFACE Profile has a particularly narrow and flat design and is designed for LED flexstrips with a maximum width of 12 mm and is universally used in interior areas (in conjunction with the PL10 construction profile and cable universal duct also as a stand-alone LED pendant lamp with cord suspension or as LED lamp fixed with mounting brackets/springs). Use the profile for application-specific installations as a recess profile.

The LED profile covers opal/satinised (translucency 65 %), clear (translucency 85 %), white/matt (translucency 75 %) or black matt (translucency 25 %) are made of shatter-proof, non-flammable polycarbonate (classification flammability UL94 V-2) and create homogeneous LED lighting conditions with high utilisation of the light output.

Covers also available in 6 m length!

This LED profiles are ideally suited as a LED light source in residential and office furniture, home accessories, display cases, shelves and stairs and of course on walls and ceilings, among other things, due to their small dimensions and low weight.

Das PL1 LED AUFBAU-Profil hat ein besonders schmales und flaches Design, ist für LED Flexbänder mit einer maximalen Breite von 12mm konzipiert und wird universell im Innenbereich (in Verbindung mit dem PL10 Aufbauprofil und Kabel-Universalkanal auch als eigenständige LED Hängeleuchte mit Seilabhängung oder als LED Leuchte fixiert mit Montageklammern/-federn) eingesetzt. Dieses Alu-Profil kann auch anwendungsspezifisch zum Einbau verwendet werden.

Die LED Profilabdeckungen Opal/satiniert (Lichtdurchlässigkeit 65 %), Klar (Lichtdurchlässigkeit 85 %), weiß/matt (Lichtdurchlässigkeit 75 %) oder Schwarz Matt (Lichtdurchlässigkeit 25 %) bestehen aus bruchsicherem und schwer brennbarem Polycarbonat (Klassifizierung Brennbarkeit UL94 V-2) und schaffen homogene LED Lichtverhältnisse mit hoher Verwertung der Lichtleistung.

Abdeckungen auch in 6 m verfügbar!

Aufgrund der kleinen Abmessungen und des geringen Gewichtes sind diese LED Profile unter anderem als ideale LED Lichtquelle in Wohn- und Büromöbeln, Wohnaccessoires, Vitrinen, Regalen sowie an Treppentufen und selbstverständlich an Wänden und Decken geeignet.

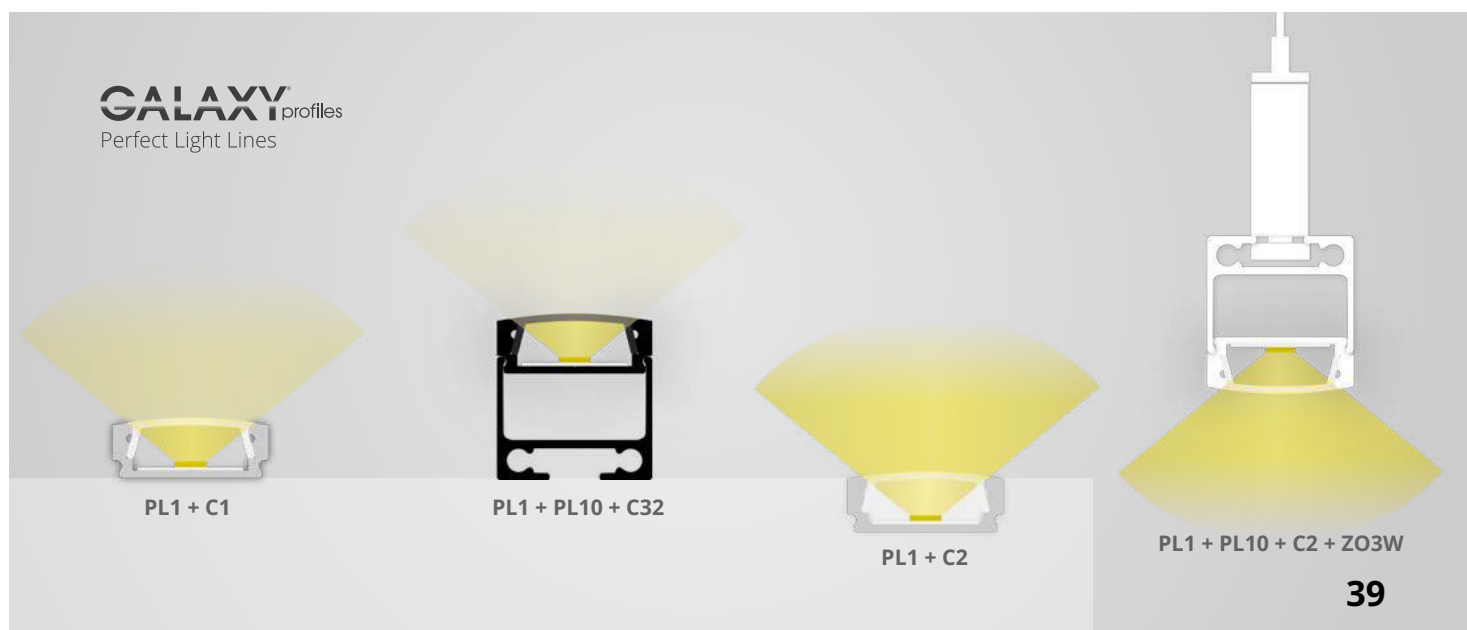

max.
12 mm

OEM

GALAXY profiles
Perfect Light Lines

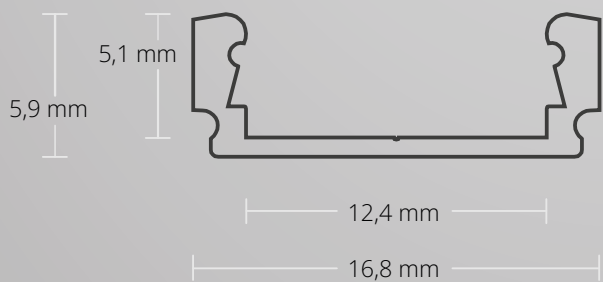

COVERS | ABDECKUNGEN

C1 65 %	200cm 8600004	250 cm 8600026	300 cm 8600080	600 cm 8600037
C2 85 %	200 cm 8600003	250 cm 8600135	300 cm 8600136	
C58 75 %	200 cm 8600154			
C32 25 %	200 cm 8600070	300 cm 8600103	600 cm 8600071	

END CAPS | ENDKAPPEN

E1	E1 8106015	E1 8106017	E1 8106018
E2	E2 8106110	E2 8106111	E2 8106112

PROFILE

PL1	200 cm 8106012	200 cm 8106013	200cm 8106014
	300 cm 8106019		
Z01	8106210 8106212 8106211		PL10.1 10 cm 8101085 200 cm 8101080
Z40	8304026	Z40W 8304028	Z40B 8304027
Z42	8304032	Z42W 8304034	Z42B 8304033

LINEAR LED PENDANT LAMP | LINEARE LED HÄNGELEUCHE

PL10	200cm 8107012	200cm 8107013	200cm 8107014
E3	E3 8106010		

Z10	8301504	Z11	8301505
Z05	8301501		
Z03	8301502	Z03W 8301512	Z03B 8301511

PL1 SURFACE | AUFBAU

flat | flach | LED Strips max. 12 mm
16,8 mm x 5,9 mm | 79 g/m

200 cm **8106012** 300 cm **8106019** 200 cm **8106013** 200 cm **8106014**

Z01 Mounting Clips
Montageklammer
Sheet steel | Stahlblech

8106210
8106212
8106211

Z40 Mounting Clips
Montageklammer
PETG

8304026
8304028
8304027

Z42 Magnet holder
Magnethalter
PETG

8304032
8304034
8304033

PL10.1 Mounting Profile
Montageprofil

10 cm **8101085**
200 cm **8101080**

max.
12 mm



OEM



COVERS | ABDECKUNGEN

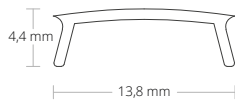

C1 opal | opal | 65 %
PC | 13,8 mm x 4,4 mm

200cm **8600004** 250cm **8600026** 300cm **8600080** 600cm **8600037**

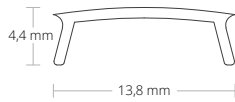

C2 clear | klar | 85 %
PC | 13,8 mm x 4,4 mm

200cm **8600003** 250cm **8600135** 300cm **8600136**

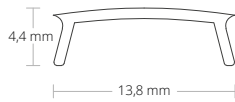

C58 white/matt | weiß/matt | 75 %
PC | 13,8 mm x 4,4 mm

200cm **8600154**



C32 black/matt | schwarz/matt | 25 %
PC | 13,8 mm x 4,4 mm

200cm **8600070** 300cm **8600103** 600cm **8600071**

END CAPS | ENDKAPPEN



E1 PVC | 1 PCS/STK

E1 **8106015** E1 **8106017** E1 **8106018**



E2 PVC | 1 PCS/STK | Cable/Kabel

E2 **8106110** E2 **8106111** E2 **8106112**

LINEAR LED PENDANT LAMP | LINEARE LED HÄNGELEUCHTE



PL10 universal duct | Universalkanal
for cable | für Kabel

200cm **8107012** 200cm **8107013** 200cm **8107014**



E3 Alu | 2 PCS/STK

incl. screws | inkl. Schraube
8106010



Z10|Z11 Connector | Verbinder
Steel | Stahl | 4 PCS/STK

Z10 | 180° **8301504** Z11 | 90° **8301505**



Z03 Hanging Wire System | Seilabhängung
Steel | Stahl | 1,5 m | Set | 75 kg

Z03 **8301502** Z03W **8301512** Z03B **8301511**



Z05 Gripper | Gelenkgripper
Steel | Stahl | 2 PCS/STK

Z05 **8301501**

PL2

SURFACE | AUFBAU

200 cm

max. 12 mm

OEM

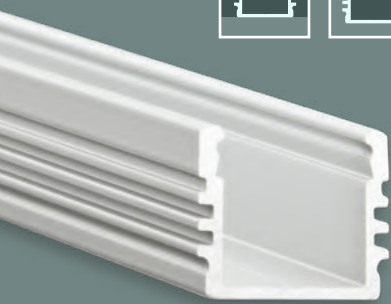
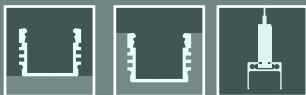

EXTENSION OF SERVICE LIFE
VERLÄNGERUNG LEBENSDAUER

MECHANICAL PROTECTION
MECHANISCHER SCHUTZ

COOLING
KÜHLUNG

HIGH LIGHT UTILISATION
HOHE LICHTVERWERTUNG

HOMOGENEOUS LIGHT
HOMOGENES LICHT

HOMOGENEOUS LIGHT with modular LED light solutions

- Wall, ceiling or floor mounting
Wand-, Decken- oder Bodenmontage
- Residential and office furniture
Wohn- und Büromöbel
- Furniture for business equipment
Möbel für Geschäftsausstattung
- Home accessories
Wohnaccessoires
- Mirrors | Spiegel
- Cabinet doors | Schranktüren
- Display cases | Vitrinen
- Shelves | Regale
- Stairs and railings
Treppenstufen und -Geländer
- Balustrades | Balustraden
- Façades, balconies and terraces
Fassaden, Balkone und Terrassen
- Living spaces | Wohnräume
- Offices | Büroräume
- Hotel and gastronomy business
Hotellerie und Gastronomie
- Retail (shop and showcase windows)
Einzelhandel (Shop- und Schaufenster)
- Business areas and showrooms
Geschäftsflächen und Showrooms
- Barber / Beauty / body art studios
Friseur-/Beauty-/Body-Art-Studios
- Halls, foyers and corridors
Hallen, Foyers und Flure
- Wellness and indoor leisure facilities
Wellness- und Indoor-Freizeitanlagen
- Wet rooms | Nasszellen

Mounting/installation on/in wood Strips and plates, plasterboard, tiles, stone, granite, marble and metal surfaces
Montage/Einbau auf/in Holzleisten und -platten, Gipsplatten, Fliesen, Stein-, Granit-, Marmor- und Metalloberflächen



PL2

SURFACE | AUFBAU

high | hoch | LED Strips max. 12 mm

Silver/Silber
ANODIZED | ELOXIERT

RAL 9010 White/Weiß
POWDER-COATED | PULVERBESCHICHTET

RAL 9005 Black/Schwarz
POWDER-COATED | PULVERBESCHICHTET



max. 12 mm

max.
12 mm



OEM



The PL2 LED SURFACE Profile has a particularly narrow design and is designed for LED flexstrips with a maximum width of 12 mm and is universally used in interior areas (in conjunction with the PL10 construction profile and cable universal duct also as a stand-alone LED pendant lamp with cord suspension or as LED lamp fixed with mounting brackets/springs). Use the profile for application-specific installations as a recess profile.

The LED profile covers opal/satinised (translucency 65 %), clear (translucency 85 %), white/matt (translucency 75 %) or black matt (translucency 25 %) are made of shatter-proof, non-flammable polycarbonate (classification flammability UL94 V-2) and create homogeneous LED lighting conditions with high utilisation of the light output.

Covers also available in 6m length!

This LED profile offers higher cooling effects as PL1 LED SURFACE Profile. This effect comes with the greater interior height. Therefore, more powerful LED flexstrips can be integrated without sacrifice to homogeneous LED light lines (no pinpoints of light but rather continuous lines of light). This LED profile is ideally suited as a LED light source in residential and office furniture, home accessories, display cases, shelves and stairs and of course on walls and ceilings, among other things, due to their small dimensions and low weight.

Das PL2 LED AUFBAU-Profil hat ein besonders schmales Design, ist für LED Flexbänder mit einer maximalen Breite von 12 mm konzipiert und wird universell im Innenbereich (in Verbindung mit dem PL10 Aufbauprofil und Kabel-Universalkanal auch als eigenständige LED Hängeleuchte mit Seilabhängung oder als LED Leuchte fixiert mit Montageklammern/-federn) eingesetzt. Dieses Alu-Profil kann auch anwendungsspezifisch zum Einbau verwendet werden.

Die LED Profilabdeckungen Opal/satiniert (Lichtdurchlässigkeit 65 %), Klar (Lichtdurchlässigkeit 85 %), weiß/matt (Lichtdurchlässigkeit 75 %) oder Schwarz Matt (Lichtdurchlässigkeit 25 %) bestehen aus bruchsicherem und schwer brennbarem Polycarbonat (Klassifizierung Brennbarkeit UL94 V-2) und schaffen homogene LED Lichtverhältnisse mit hoher Verwertung der Lichtleistung.

Abdeckungen auch in 6 m verfügbar!

Dieses LED Profil hat aufgrund seiner im Vergleich zum PL1 LED AUFBAU-Profil größeren Innenhöhe auch einen größeren Kühlkörper und kann somit mit stärkeren LED Flexbändern bestückt werden, ohne dabei auf homogene LED Lichtlinien verzichten zu müssen (keine Lichtpunkte, sondern durchgängige Lichtlinie). Wegen der kleinen Abmessungen und des geringen Gewichtes ist dieses Profilsystem unter anderem als ideale LED Lichtquelle in Wohn- und Büromöbeln, Wohnaccessoires, Vitrinen, Regalen sowie an Treppenstufen und selbstverständlich an Wänden und Decken geeignet.

GALAXY profiles
Perfect Light Lines

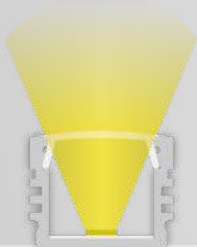

PL2 + C2

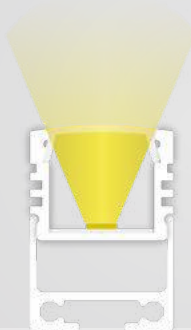

PL2 + PL10 + C1



PL2 + PL10 + C32

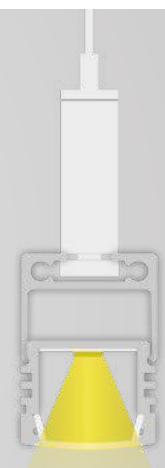

PL2 + PL10 + C1 + Z03

max. 12 mm

OEM

GALAXY profiles
Perfect Light Lines

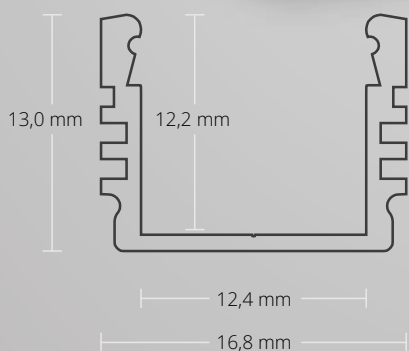
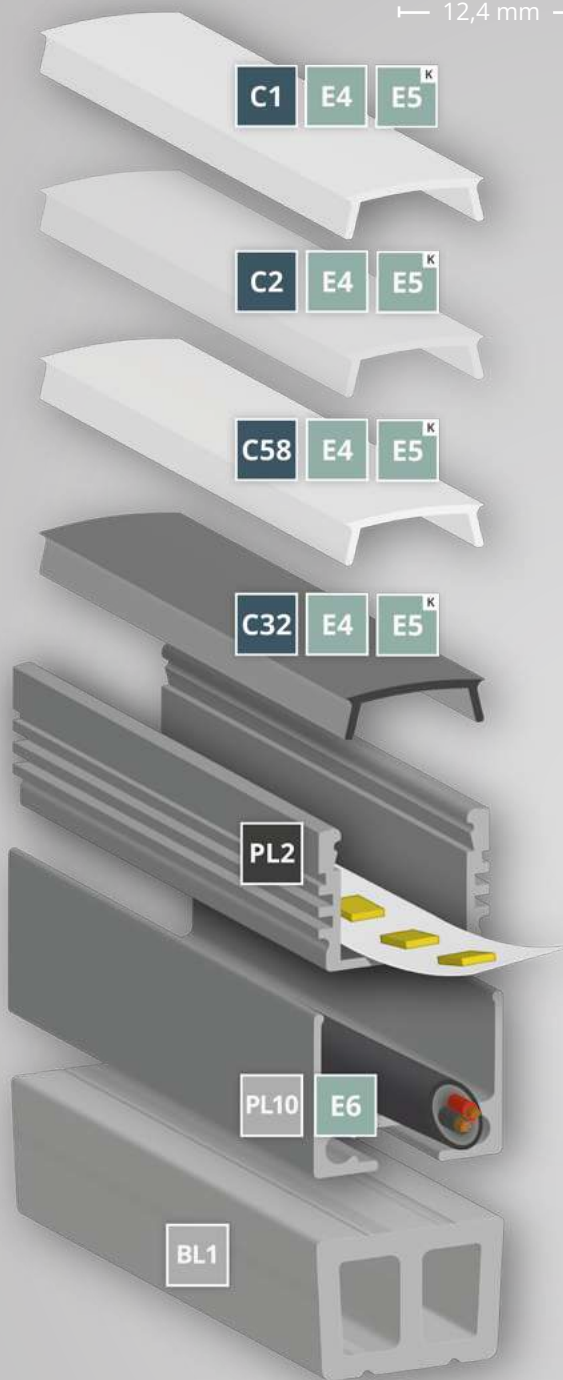
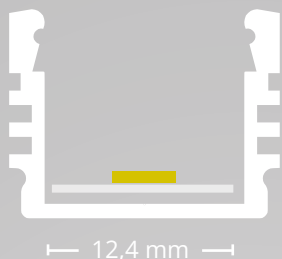

COVERS | ABDECKUNGEN

C1 65 %	200cm 8600004	250cm 8600026	300cm 8600080	600cm 8600037
C2 85 %	200cm 8600003	250cm 8600135	300cm 8600136	
C58 75 %	200cm 8600154			
C32 25 %	200cm 8600070	300cm 8600103	600cm 8600071	

END CAPS | ENDKAPPEN

E4	E4 8106125	E4 8106126	E4 8106127
E5	E5 8106020	E5 8106027	E5 8106028

PROFILE

PL2	200cm 8106022	200cm 8106023	200cm 8106024
	300cm 8106029		
	Z01 8106210		PL10.1 10cm 8101085 200cm 8101080
	Z41 8304029	Z41W 8304031	Z41B 8304030
	Z43 8304035	Z43W 8304037	Z43B 8304036
BL1	200cm 8123334		

LINEAR LED PENDANT LAMP | LINEARE LED HÄNGELEUCHTE

PL10	200cm 8107012	200cm 8107013	200cm 8107014
E6	E6 8106115		
	Z10 8301504		Z11 8301505
	Z05 8301501		
	Z03 8301502	Z03W 8301512	Z03B 8301511

**INSTALLATION INSTRUCTION
INSTALLATIONS MONTAGE**

PL2 SURFACE | AUFBAU

high | hoch | LED Strips max. 12 mm
16,8 mm x 13,0 mm | 138 g/m

200 cm **8106022** 300 cm **8106029** 200 cm **8106023** 200 cm **8106024**

Z01 Mounting Clips
Montageklammer
Sheet steel | Stahlblech
8106210
8106212
8106211

Z41 Mounting Clips
Montageklammer
PETG
8304029
8304031
8304030

Z43 Magnet holder
Magnethalter
PETG
8304035
8304037
8304036

BL1 Concrete insert profile |
Beton-Einlegeprofil
200cm **8123334**
More P. 34 | Mehr S. 34

PL10.1 Mounting Profile
Montageprofil
10 cm **8101085**
200 cm **8101080**

max.
12 mm



OEM



COVERS | ABDECKUNGEN

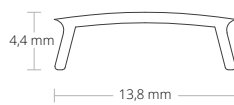

C1 opal | opal | 65 %
PC | 13,8 mm x 4,4 mm
200cm **8600004** 250cm **8600026** 300cm **8600080** 600cm **8600037**



C2 clear | klar | 85 %
PC | 13,8 mm x 4,4 mm
200cm **8600003** 250cm **8600135** 300cm **8600136**



C58 white/matt | weiß/matt | 75 %
PC | 13,8 mm x 4,4 mm
200cm **8600154**



C32 black/matt | schwarz/matt | 25 %
PC | 13,8 mm x 4,4 mm
200cm **8600070** 300cm **8600103** 600cm **8600071**

END CAPS | ENDKAPPEN

E4 PVC | 1 PCS/STK
E4 **8106125** E4 **8106126** E4 **8106127**

E5 PVC | 1 PCS/STK | Cable/Kabel
E5 **8106020** E5 **8106027** E5 **8106028**

LINEAR LED PENDANT LAMP | LINEARE LED HÄNGELEUCHE



PL10 universal duct | Universalkanal
for cable | für Kabel

200cm **8107012** 200cm **8107013** 200cm **8107014**

Z10|Z11 Connector | Verbinder
Steel | Stahl | 4 PCS/STK
Z10 | 180° **8301504** Z11 | 90° **8301505**

E6 Alu | 2 PCS/STK
incl. screws | inkl. Schraube
8106115

Z03 Hanging Wire System | Seilabhängung
Steel | Stahl | 1,5 m | Set | 75 kg
Z03 **8301502** Z03W **8301512** Z03B **8301511**

Z05 Gripper | Gelenkgripper
Steel | Stahl | 2 PCS/STK
Z05 **8301501**

PL3

RECESSED | EINBAU

200 cm

max. 12 mm

OEM



EXTENSION OF SERVICE LIFE
VERLÄNGERUNG LEBENSDAUER

MECHANICAL PROTECTION
MECHANISCHER SCHUTZ

COOLING
KÜHLUNG

HIGH LIGHT UTILISATION
HOHE LICHTVERWERTUNG

HOMOGENEOUS LIGHT
HOMOGENES LICHT

HOMOGENEOUS LIGHT with modular LED light solutions

- Wall, ceiling or floor mounting
Wand-, Decken- oder Bodenmontage
- Residential and office furniture
Wohn- und Büromöbel
- Furniture for business equipment
Möbel für Geschäftsausstattung
- Home accessories
Wohnaccessoires
- Cabinet doors | Schranktüren
- Display cases | Vitrinen
- Shelves | Regale
- Wet rooms | Nasszellen
- Stairs and railings
Treppenstufen und -Geländer
- Balustrades | Balustraden
- Façades, balconies and terraces
Fassaden, Balkone und Terrassen
- Living spaces | Wohnräume
- Offices | Büroräume
- Hotel and gastronomy business
Hotellerie und Gastronomie
- Retail (shop and showcase windows)
Einzelhandel (Shop- und Schaufenster)
- Business areas and showrooms
Geschäftsflächen und Showrooms
- Barber / Beauty / body art studios
Friseur-/Beauty-/Body-Art-Studios
- Halls, foyers and corridors
Hallen, Foyers und Flure
- Wellness and indoor leisure facilities
Wellness- und Indoor-Freizeitanlagen

Mounting/installation on/in wood Strips and plates, plasterboard, tiles, stone, granite, marble and metal surfaces
Montage/Einbau auf/in Holzleisten und -platten, Gipsplatten, Fliesen, Stein-, Granit-, Marmor- und Metalloberflächen



PL3

RECESSED | EINBAU

high/wings | hoch/Flügel | LED Strips max. 12 mm

 Silver/Silber
ANODIZED | ELOXIERT

 RAL 9010 White/Weiß
POWDER-COATED | PULVERBESCHICHTET

 RAL 9005 Black/Schwarz
POWDER-COATED | PULVERBESCHICHTET



max. 12 mm

**max.
12 mm**



OEM



PL3 LED RECESSED Profile has a particularly narrow design, is designed for LED flexstrips with a maximum width of 12 mm and is universally used in interior areas.

The LED profile covers opal/satinised (translucency 65 %), clear (translucency 85 %), white/matt (translucency 75 %) or black matt (translucency 25 %) are made of shatter-proof, non-flammable polycarbonate (classification flammability UL94 V-2) and create homogeneous LED lighting conditions with high utilisation of the light output (no pinpoints of light, but rather continuous line of light).

Covers also available in 6m length!

These LED RECESSED Profiles are barely visible inserted/sunk in walls and ceilings with plaster, stone or concrete panels as well as wood panelling (optionally with the additional cable universal duct PL10) due to their small dimensions and low weight. They can be installed in pre-milled furniture. They are thus ideal LED light sources in residential and office furniture, home accessories, display cases, shelves, stairs and, of course, on walls and ceilings.

Das PL3 LED EINBAU-Profil hat ein besonders schmales Design, ist für LED Flexbänder mit einer maximalen Breite von 12 mm konzipiert und wird universell im Innenbereich eingesetzt.

Die LED Profilabdeckungen Opal/satiniert (Lichtdurchlässigkeit 65 %), Klar (Lichtdurchlässigkeit 85 %), weiß/matt (Lichtdurchlässigkeit 75 %) oder Schwarz Matt (Lichtdurchlässigkeit 25 %) bestehen aus bruchsicherem und schwer brennbarem Polycarbonat (Klassifizierung Brennbarkeit UL94 V-2) und schaffen homogene LED Lichtverhältnisse mit hoher Verwertung der Lichtleistung (keine Lichtpunkte, sondern durchgängige Lichtlinie).

Abdeckungen auch in 6 m verfügbar!

Diese LED EINBAU-Profile werden aufgrund ihrer kleinen Abmessungen und des geringen Gewichtes in Wänden und Decken mit Gips-, Stein- oder Betonplatten sowie Holzverkleidungen kaum sichtbar versenkt (optional mit dem zusätzlichen Kabel-Universalkanal PL10). Sie können auch in vorgefräste Möbel installiert werden. Sie sind somit ideale LED Lichtquellen in Wohn- und Büromöbeln, Wohnaccessoires, Vitrinen, Regalen, an Treppenstufen und selbstverständlich an Wänden und Decken.

GALAXY profiles
Perfect Light Lines

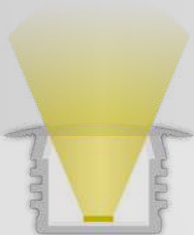

PL3 + C2

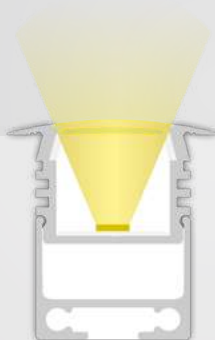

PL3 + C1

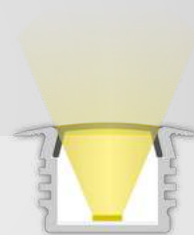

PL3 + C32

max.
12 mm

OEM



GALAXY profiles
Perfect Light Lines

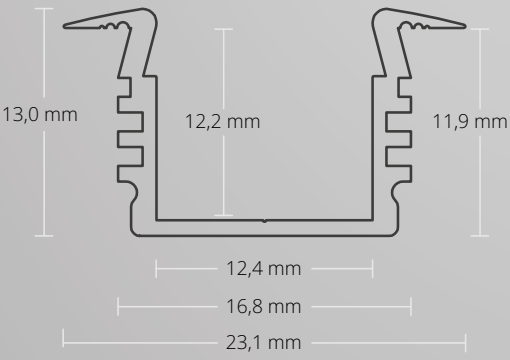
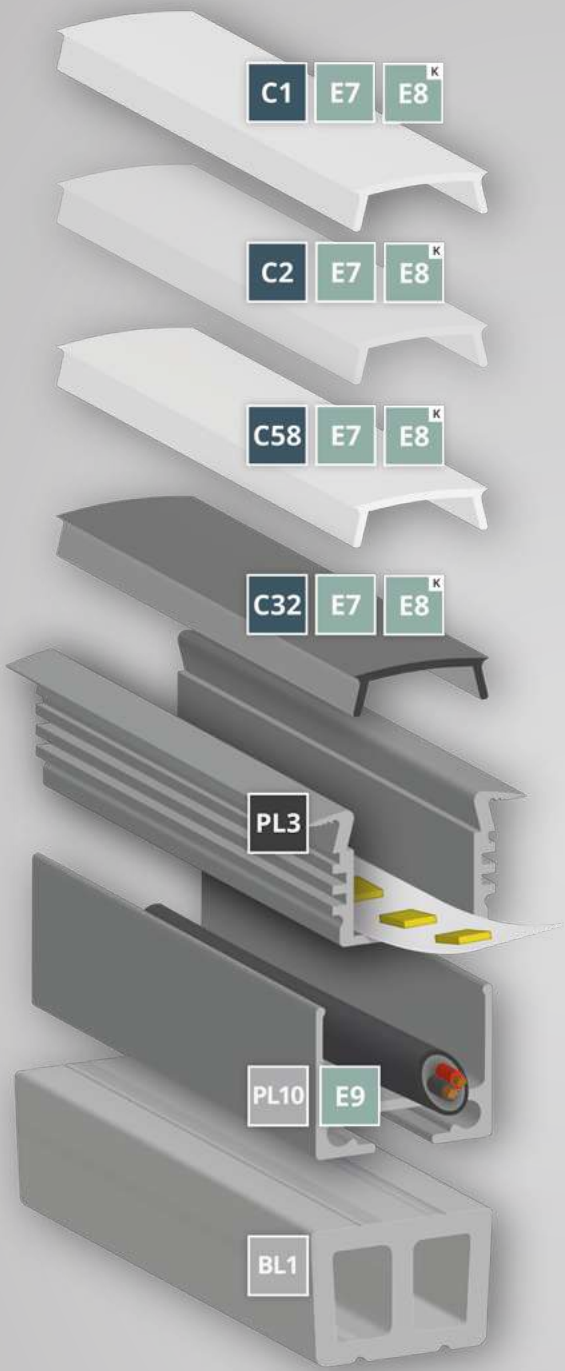
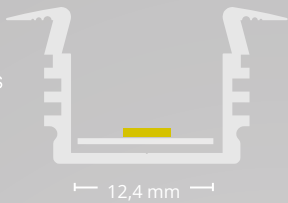

COVERS | ABDECKUNGEN

C1 65 %	200cm 8600004	250 cm 8600026	300 cm 8600080	600 cm 8600037
C2 85 %	200 cm 8600003	250 cm 8600135	300 cm 8600136	
C58 75 %	200 cm 8600154			
C32 25 %	200 cm 8600070	300 cm 8600103	600 cm 8600071	

END CAPS | ENDKAPPEN

E7	E7 8106135	E7 8123204	E7 8123203
E8	E8 8106030	E8 8123206	E8 8123205

PROFILE

PL3	200 cm 8106032	200cm 8106034	200cm 8106033
	Z01 8106210	Z02	PL10.1 10 cm 8101085 200 cm 8101080
BL1	200cm 8123334	Z61 8123554 8123555 8123556	
	Z62 8192287		

LINEAR LED PENDANT LAMP | LINEARE LED HÄNGELEUCHE

PL10	200cm 8107012		
E9	E9 8106120		
	Z10 8301504	Z11 8301505	
	Z05 8301501		
	Z03 8301502	Z03W 8301512	Z03B 8301511

INSTALLATION INSTRUCTION
INSTALLATIONS MONTAGE

BETON EINLEGEPROFIL





PL3 RECESSED | EINBAU

high/wings | hoch/Flügel | LED Strips max. 12 mm
23,1 mm x 13,0 mm | 140 g/m

200 cm
8106032

200 cm
8106034

200 cm
8106033



BL1
Concrete insert profile |
Beton-Einlegeprofil

200cm
8123334

More P. 34 | Mehr S. 34

max.
12 mm

OEM



Z01
Mounting Clips
Montageklammer

8106210

8106212

8106211



PL10.1
Mounting Profile
Montageprofil

10 cm 8101085

200 cm 8101080



Z61 NEW

Mounting Clips swivelling
Montageklammer schwenkba

8123554

8123555

8123556



Z62 NEW

Mounting Clips
with extension spring
Montageklammer
mit Zugfeder
Spring steel | Federstahl

8192287

COVERS | ABDECKUNGEN



C1 opal | opal | 65 %
PC | 13,8 mm x 4,4 mm

200cm
8600004

250cm
8600026

300cm
8600080

600cm
8600037



C2 clear | klar | 85 %

PC | 13,8 mm x 4,4 mm

200cm
8600003

250cm
8600135

300cm
8600136

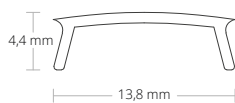

C58 white/matt | weiß/matt | 75 %

PC | 13,8 mm x 4,4 mm

200cm
8600154

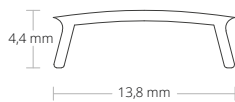

C32 black/matt | schwarz/matt | 25 %

PC | 13,8 mm x 4,4 mm

200cm
8600070

300cm
8600103

600cm
8600071

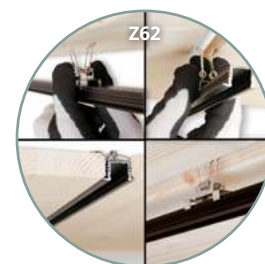

END CAPS | ENDKAPPEN



E7 PVC | 1 PCS/STK

E7
8106135

E7
8123204

E7
8123203



E8 PVC | 1 PCS/STK | Cable/Kabel

E8
8106030

E8
8123206

E8
8123205

LINEAR LED PENDANT LAMP | LINEARE LED HÄNGELEUCHTE



PL10 universal duct | Universalkanal
for cable | für Kabel

200cm
8107012

200cm
8107013

200cm
8107014



E9 Alu | 2 PCS/STK

incl. screws | inkl. Schraube
8106120



Z10|Z11 Connector | Verbinder
Steel | Stahl | 4 PCS/STK

Z10 | 180°
8301504

Z11 | 90°
8301505



Z03 Hanging Wire System | Seilabhängung
Steel | Stahl | 1,5 m | Set | 75 kg

Z03
8301502

Z03W
8301512

Z03B
8301511



Z05 Gripper | Gelenkgripper
Steel | Stahl | 2 PCS/STK

Z05
8301501



PL4

SURFACE | AUFBAU

200 cm | 300 cm

max. 10 mm

 OEM



EXTENSION OF SERVICE LIFE
VERLÄNGERUNG LEBENSDAUER

MECHANICAL PROTECTION
MECHANISCHER SCHUTZ

COOLING
KÜHLUNG

HIGH LIGHT UTILISATION
HOHE LICHTVERWERTUNG

HOMOGENEOUS LIGHT
HOMOGENES LICHT

HOMOGENEOUS LIGHT with modular LED light solutions

- Wall, ceiling or floor mounting
Wand-, Decken- oder Bodenmontage
- Residential and office furniture
Wohn- und Büromöbel
- Furniture for business equipment
Möbel für Geschäftsausstattung
- Home accessories
Wohnaccessoires
- Mirrors | Spiegel
- Cabinet doors | Schranktüren
- Display cases | Vitrinen
- Shelves | Regale
- Stairs and railings
Treppenstufen und -Geländer
- Balustrades | Balustraden
- Façades, balconies and terraces
Fassaden, Balkone und Terrassen
- Living spaces | Wohnräume
- Offices | Büroräume
- Hotel and gastronomy business
Hotellerie und Gastronomie
- Retail (shop and showcase windows)
Einzelhandel (Shop- und Schaufenster)
- Business areas and showrooms
Geschäftsflächen und Showrooms
- Barber / Beauty / body art studios
Friseur-/Beauty-/Body-Art-Studios
- Halls, foyers and corridors
Hallen, Foyers und Flure
- Wellness and indoor leisure facilities
Wellness- und Indoor-Freizeitanlagen
- Wet rooms | Nasszellen

Mounting/installation on/in wood Strips and plates, plasterboard, tiles, stone, granite, marble and metal surfaces
Montage/Einbau auf/in Holzleisten und -platten, Gipsplatten, Fliesen, Stein-, Granit-, Marmor- und Metalloberflächen



PL4

SURFACE | AUFBAU

high | hoch | LED Strips max. 10 mm

Silver/Silber
ANODIZED | ELOXIERT

RAL 9010 White/Weiß
POWDER-COATED | PULVERBESCHICHTET

RAL 9005 Black/Schwarz
POWDER-COATED | PULVERBESCHICHTET



max. 10 mm

max.
10 mm



OEM



This PL4 LED SURFACE profile has an especially narrow and flat design, is designed for LED stripes with a maximum width of 10 mm and is used universally in interiors. With appropriate mounting clamps, this profile system can also be fixed to ceilings and walls as an autonomous LED luminaire. This aluminium profile can also be used for installation for certain applications.

The LED profile covers opal/satinised (translucency 65 %), or black matt (translucency 25 %) are made of shatter-proof and flame-retardant polycarbonate (flammability classification UL94 V-2) and create homogeneous LED lighting conditions with high utilisation of the light output.

Special feature: the cover is flush with the profile. This means only the LED light strip remains visible.

This LED profile has a generous internal height and offers even stronger LED stripes a sufficient heat sink to dissipate heat. Homogeneous LED light lines without light points.

Thanks to their small size and low weight, these LED profiles are an ideal LED light source in home and office furniture, home accessories, showcases, shelves as well as on stairs and of course on walls and ceilings.

Das PL4 LED AUFBAU-Profil hat ein besonders schmales und flaches Design, ist für LED Flexbänder mit einer maximalen Breite von 10 mm konzipiert und wird universell im Innenbereich eingesetzt. Mit entsprechenden Montageklammern kann dieses Profilsystem auch als eigenständige LED Leuchte an Decken und Wänden fixiert werden. Dieses Alu-Profil kann anwendungsspezifisch auch zum Einbau verwendet werden.

Die LED Profilabdeckungen Opal/satiniert (Lichtdurchlässigkeit 65 %) oder Schwarz Matt (Lichtdurchlässigkeit 25 %) bestehen aus bruchsicherem und schwer brennbarem Polycarbonat (Klassifizierung Brennbarkeit UL94 V-2) und schaffen homogene LED Lichtverhältnisse mit hoher Verwertung der Lichtleistung.

Besonderheit: die Abdeckung schließt bündig mit dem Profil ab. Somit ist nur noch die LED Lichtleiste sichtbar.

Dieses LED Profil hat eine großzügige Innenhöhe und bietet auch stärkeren LED Flexbändern einen ausreichenden Kühlkörper zum Ableiten der Wärme. Homogene LED Lichtlinien ohne Lichtpunkte.

Wegen der kleinen Abmessungen und des geringen Gewichtes sind diese LED Profile unter anderem als ideale LED Lichtquelle in Wohn- und Büromöbeln, Wohnaccessoires, Vitrinen, Regalen sowie an Treppenstufen und selbstverständlich an Wänden und Decken geeignet.

GALAXY profiles
Perfect Light Lines

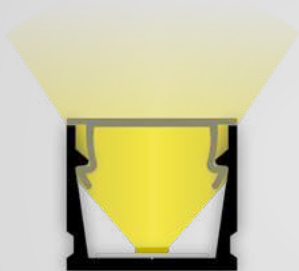

PL4 + C44



PL4 + C43

- max. 10 mm
- OEM

GALAXY profiles
Perfect Light Lines

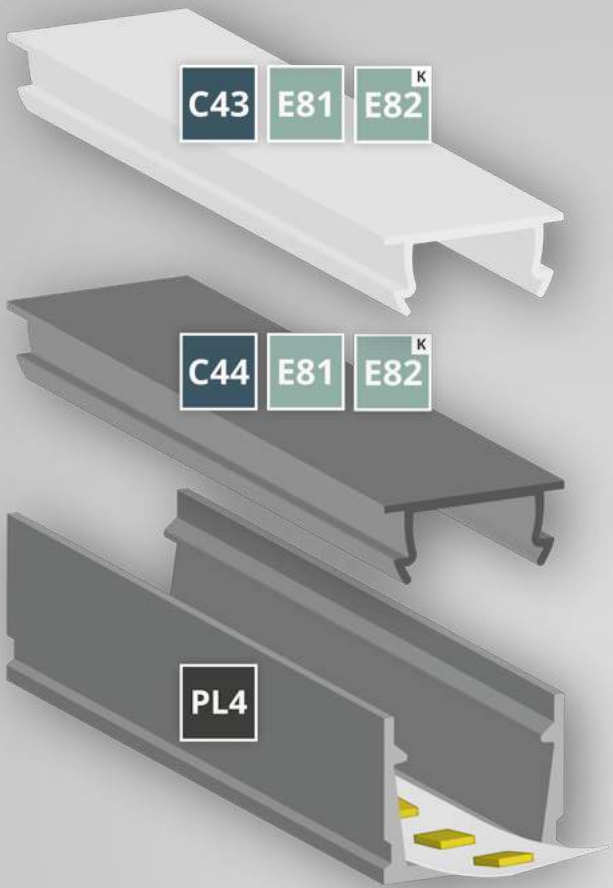
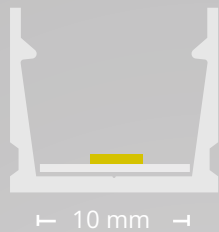

COVERS | ABDECKUNGEN

C43 65 % 200cm 8600093 300cm 8600114

C44 25 % 200cm 8600094 300cm 8600115

END CAPS | ENDKAPPEN

E81 E81 8122050 E81 8123324 E81 8122052

E82 E82 8122051 E82 8123325 E82 8122053

PROFILE

PL4 200 cm 8122000 200 cm 8102240 200 cm 8122020
 300 cm 8122002 300 cm 8102242 300 cm 8122022

Z32 8122040

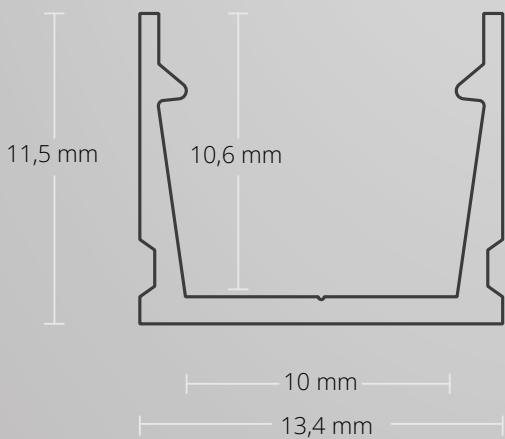

PL4 SURFACE | AUFBAU

high | hoch | LED Strips max. 10 mm
13,4 mm x 11,5 mm | 95 g/m

200 cm
8122000

300 cm
8122002

200 cm
8102240

300 cm
8102242

200 cm
8122020

300 cm
8122022



Z32

Mounting Clips
Montageklammer
Sheet steel | Stahlblech
8122040

max.
10 mm



OEM



COVERS | ABDECKUNGEN

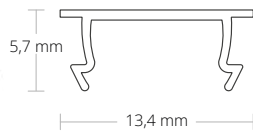

C43 opal | opal | 65 %

PC | 13,4 mm x 5,7 mm
200cm 300cm
8600093 8600114

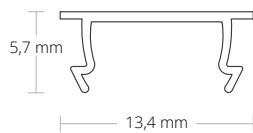

C44 black/matt | schwarz/matt | 25 %

PC | 13,4 mm x 5,7 mm
200cm 300cm
8600094 8600115

END CAPS | ENDKAPPEN



E81 PVC | 1 PCS/STK

E81
8122050

E81
8123324

E81
8122052



E82 PVC | 1 PCS/STK | Cable/Kabel

E82
8122051

E82
8123325

E82
8122053

PL5

SURFACE | AUFBAU

200 cm | 300 cm

max. 12 mm

OEM



EXTENSION OF SERVICE LIFE
VERLÄNGERUNG LEBENSDAUER

MECHANICAL PROTECTION
MECHANISCHER SCHUTZ

COOLING
KÜHLUNG

HIGH LIGHT UTILISATION
HOHE LICHTVERWERTUNG

HOMOGENEOUS LIGHT
HOMOGENES LICHT

HOMOGENEOUS LIGHT with modular LED light solutions

- Wall, ceiling or floor mounting
Wand-, Decken- oder Bodenmontage
- Residential and office furniture
Wohn- und Büromöbel
- Furniture for business equipment
Möbel für Geschäftsausstattung
- Home accessories
Wohnaccessoires
- Mirrors | Spiegel
- Cabinet doors | Schranktüren
- Display cases | Vitrinen
- Shelves | Regale
- Stairs and railings
Treppenstufen und -Geländer
- Balustrades | Balustraden
- Façades, balconies and terraces
Fassaden, Balkone und Terrassen
- Living spaces | Wohnräume
- Offices | Büroräume
- Hotel and gastronomy business
Hotellerie und Gastronomie
- Retail (shop and showcase windows)
Einzelhandel (Shop- und Schaufenster)
- Business areas and showrooms
Geschäftsflächen und Showrooms
- Barber / Beauty / body art studios
Friseur-/Beauty-/Body-Art-Studios
- Halls, foyers and corridors
Hallen, Foyers und Flure
- Wellness and indoor leisure facilities
Wellness- und Indoor-Freizeitanlagen
- Wet rooms | Nasszellen

Mounting/installation on/in wood Strips and plates, plasterboard, tiles, stone, granite, marble and metal surfaces
Montage/Einbau auf/in Holzleisten und -platten, Gipsplatten, Fliesen, Stein-, Granit-, Marmor- und Metalloberflächen



PL5

SURFACE | AUFBAU

high | hoch | LED Strips max. 12 mm

Silver/Silber
ANODIZED | ELOXIERT

RAL 9010 White/Weiß
POWDER-COATED | PULVERBESCHICHTET

RAL 9005 Black/Schwarz
POWDER-COATED | PULVERBESCHICHTET



max. 12 mm

max.
12 mm



OEM



The PL5 LED SURFACE Profile has a particularly narrow design and is designed for LED flexstrips with a maximum width of 12 mm and is universally used in interior areas (in conjunction with the PL10 construction profile and cable universal duct also as a stand-alone LED pendant lamp with cord suspension or as LED lamp fixed with mounting brackets/springs). Use the profile for application-specific installations as a recess profile.

The LED profile covers opal/satinised (translucency 65 %) are made of shatter-proof, non-flammable polycarbonate (classification flammability UL94 V-2) and create homogeneous LED lighting conditions with high utilisation of the light output (no pinpoints of light, but rather a continuous line of light).

Covers also available in 6m length!

This LED SURFACE Profile can be fitted with three different plastic covers - flat, high or round cover. All three covers enclose the SURFACE profile on the open side. Thus only the LED light bar is visible. With the flat cover, the light shines in one direction, however, with the high and round cover, the light illuminates the LED strips in three directions (also on the side).

The PL5 LED SURFACE Profile has a large heat sink and can therefore be equipped with stronger LED flexstrips. It is ideally suited as a LED light source in residential and office furniture, home accessories, display cases, shelves and stairs and of course on walls and ceilings, among other things, due to their small dimensions and low weight.

Das PL5 LED AUFBAU-Profil hat ein besonders schmales Design, ist für LED Flexbänder mit einer maximalen Breite von 12 mm konzipiert und wird universell im Innenbereich (in Verbindung mit dem PL10 Aufbauprofil und Kabel-Universalkanal auch als eigenständige LED Hängeleuchte mit Seilabhängung oder als LED Leuchte fixiert mit Montageklammern/-federn) eingesetzt. Dieses Alu-Profil kann auch anwendungsspezifisch zum Einbau verwendet werden.

Die LED Profilabdeckungen Opal/satiniert (Lichtdurchlässigkeit 65 %) bestehen aus bruchsicherem und schwer brennbarem Polycarbonat (Klassifizierung Brennbarkeit UL94 V-2) und schaffen homogene LED Lichtverhältnisse mit hoher Verwertung der Lichtleistung (keine Lichtpunkte, sondern durchgängige Lichtlinie).

Abdeckungen auch in 6 m verfügbar!

Dieses LED AUFBAU-Profil kann mit drei unterschiedlichen Kunststoffabdeckungen bestückt werden – flache, hohe oder runde Abdeckung. Alle drei Abdeckungen umschließen das AUFBAU-Profil an der offenen Seite. Somit ist nur noch die LED Lichtleiste sichtbar. Bei der flachen Abdeckung strahlt das Licht in eine Richtung, hingegen bei der hohen und runden Abdeckung leuchtet das Licht der LED Strips in drei Richtungen (auch seitlich).

Das PL5 LED AUFBAU-Profil hat einen großen Kühlkörper und kann somit mit stärkeren LED Flexbändern bestückt werden. Wegen der kleinen Abmessungen und des geringen Gewichtes ist es unter anderem als ideale LED Lichtquelle in Wohn- und Büromöbeln, Wohnaccessoires, Vitrinen sowie an Treppenstufen, Regalen, Wänden und Decken geeignet.

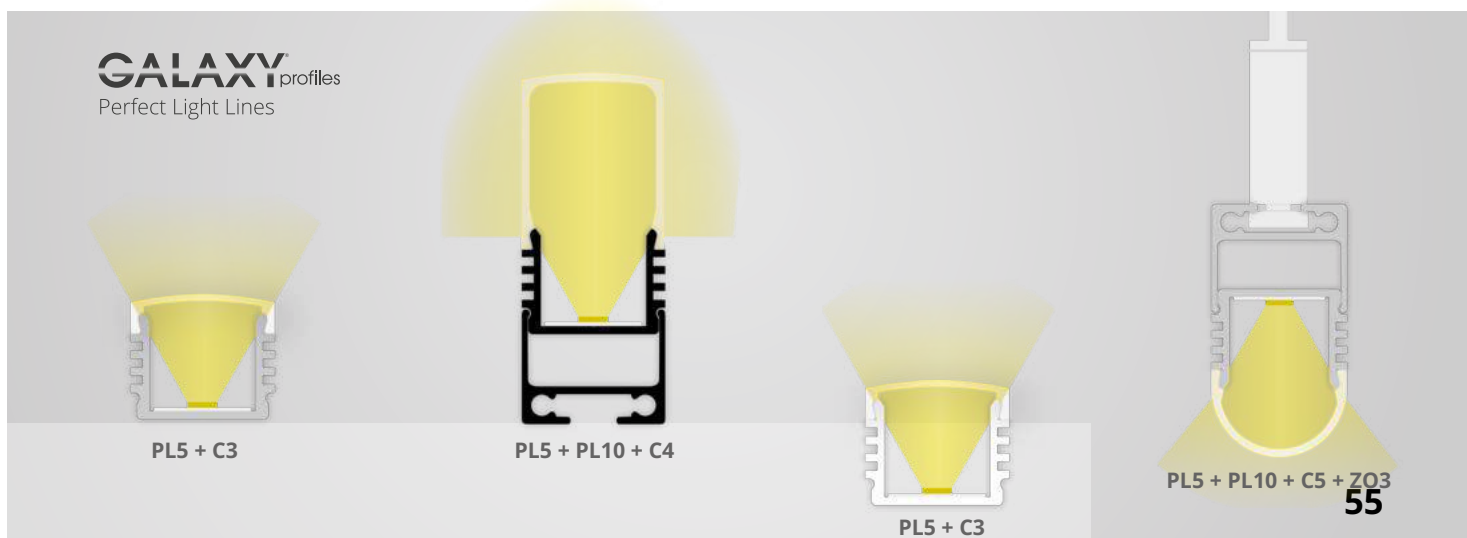

- max. 12 mm
- OEM

GALAXY profiles
Perfect Light Lines

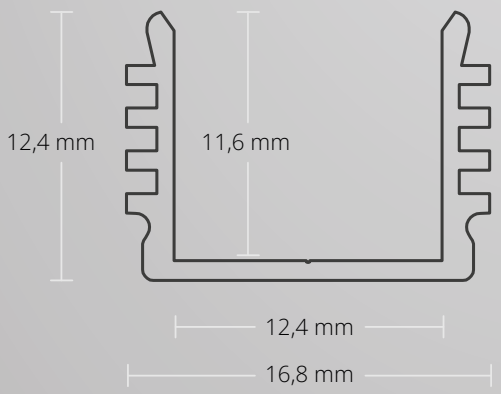
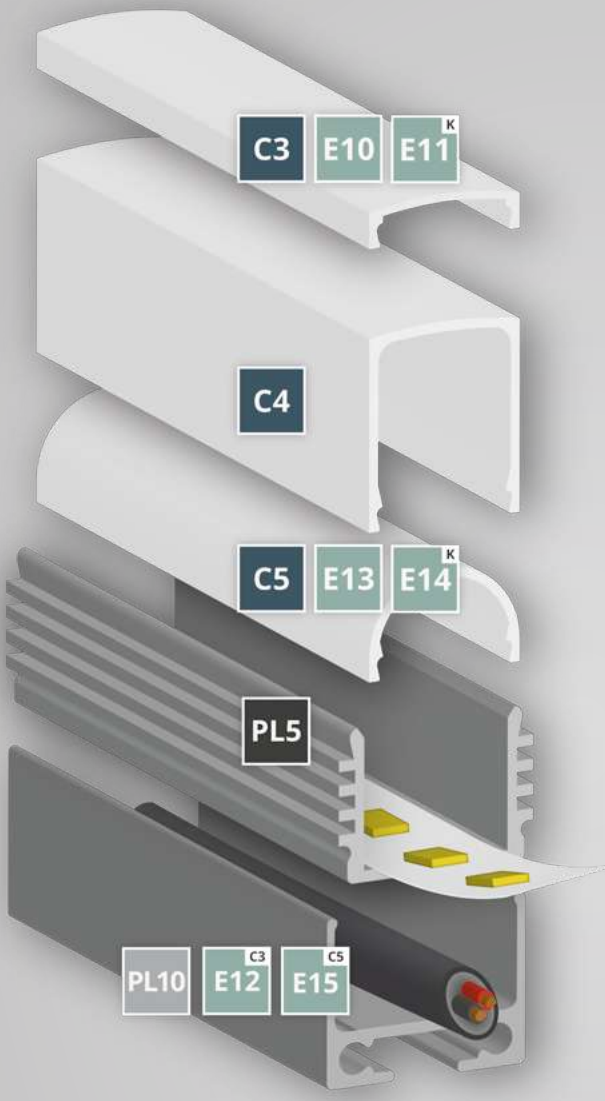
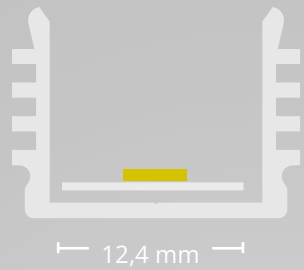

COVERS | ABDECKUNGEN

C3 65 %	200cm 8600005	300 cm 8600027	600 cm 8600038
C4 65 %	200 cm 8600006		
C5 65 %	200 cm 8600007		

END CAPS | ENDKAPPEN

E10	E10 8106050	E10 8106049	E10 8106051
C3			
E11	E11 8106052	E11 8106053	E11 8106054
E13	E13 8106155	E13 8106156	E13 8106157
C5			
E14	E14 8106057	E14 8106058	E14 8106059

PROFILE

PL5	200 cm 8105201	200cm 8105203	200cm 8105204
	Z01 8106210 8106212 8106211		PL10.1 10 cm 8101085 200 cm 8101080

LINEAR LED PENDANT LAMP | LINEARE LED HÄNGELEUCHE

PL10	200cm 8107012	200cm 8107013	200cm 8107014
E12 C3	E12 8106025		
E15 C5	E15 8106055		
	Z10 8301504	Z11 8301505	
	Z05 8301501		
	Z03 8301502	Z03W 8301512	Z03B 8301511



PL5 SURFACE | AUFBAU

high | hoch | LED Strips max. 12 mm
16,8 mm x 12,4 mm | 125 g/m

- 200 cm **8105201**
- 200 cm **8105203**
- 200 cm **8105204**

Z01
Mounting Clips
Montageklammer
Sheet steel | Stahlblech

- 8106210**
- 8106212**
- 8106211**



PL10.1
Mounting Profile
Montageprofil

- 10 cm **8101085**
- 200 cm **8101080**

max.
12 mm

OEM

COVERS | ABDECKUNGEN

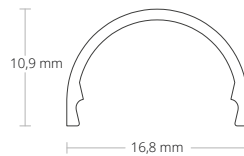
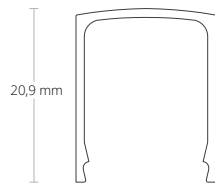

C3 opal | opal | 65 %
PC | 16,8 mm x 4,6 mm
200cm **8600005** 300cm **8600027** 600cm **8600038**

C4 opal | opal | 65 %
PC | 16,8 mm x 20,9 mm
200cm **8600006**

C5 opal | opal | 65 %
PC | 16,8 mm x 10,9 mm
200cm **8600007**

END CAPS | ENDKAPPEN



E10 C3 PVC | 1 PCS/STK

- E10 **8106050**
- E10 **8106049**
- E10 **8106051**



E11 C3 PVC | 1 PCS/STK | Cable/Kabel

- E11 **8106052**
- E11 **8106053**
- E11 **8106054**



E13 C5 PVC | 1 PCS/STK

- E13 **8106155**
- E13 **8106156**
- E13 **8106157**



E14 C5 PVC | 1 PCS/STK | Cable/Kabel

- E14 **8106057**
- E14 **8106058**
- E14 **8106059**

max.
12 mm



OEM



LINEAR LED PENDANT LAMP | LINEARE LED HÄNGELEUCHTE



PL10 universal duct | Universalkanal
for cable | für Kabel

- 200cm **8107012**
- 200cm **8107013**
- 200cm **8107014**



E12 C3 Alu | 2 PCS/STK
incl. screws | inkl. Schraube
8106025



E15 C5 Alu | 2 PCS/STK
incl. screws | inkl. Schraube
8106055



Z10|Z11 Connector | Verbinder
Steel | Stahl | 4 PCS/STK

- Z10 | 180° **8301504**
- Z11 | 90° **8301505**



Z03 Hanging Wire System | Seilabhangung
Steel | Stahl | 1,5 m | Set | 75 kg

- Z03 **8301502**
- Z03W **8301512**
- Z03B **8301511**



Z05 Gripper | Gelenkgripper
Steel | Stahl | 2 PCS/STK

- Z05 **8301501**



max.
12 mm



OEM



PL6

SURFACE | AUFBAU

200 cm

max. 12 mm

OEM

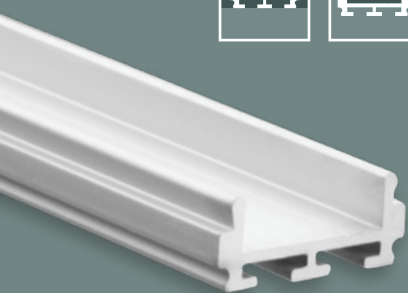

EXTENSION OF SERVICE LIFE
VERLÄNGERUNG LEBENSDAUER

MECHANICAL PROTECTION
MECHANISCHER SCHUTZ

COOLING
KÜHLUNG

HIGH LIGHT UTILISATION
HOHE LICHTVERWERTUNG

HOMOGENEOUS LIGHT
HOMOGENES LICHT

HOMOGENEOUS LIGHT with modular LED light solutions

- Wall, ceiling or floor mounting
Wand-, Decken- oder Bodenmontage
- Residential and office furniture
Wohn- und Büromöbel
- Furniture for business equipment
Möbel für Geschäftsausstattung
- Home accessories
Wohnaccessoires
- Mirrors | Spiegel
- Cabinet doors | Schranktüren
- Display cases | Vitrinen
- Shelves | Regale
- Stairs and railings
Treppenstufen und -Geländer
- Balustrades | Balustraden
- Façades, balconies and terraces
Fassaden, Balkone und Terrassen
- Living spaces | Wohnräume
- Offices | Büroräume
- Hotel and gastronomy business
Hotellerie und Gastronomie
- Retail (shop and showcase windows)
Einzelhandel (Shop- und Schaufenster)
- Business areas and showrooms
Geschäftsflächen und Showrooms
- Barber / Beauty / body art studios
Friseur-/Beauty-/Body-Art-Studios
- Halls, foyers and corridors
Hallen, Foyers und Flure
- Wellness and indoor leisure facilities
Wellness- und Indoor-Freizeitanlagen
- Wet rooms | Nasszellen

Mounting/installation on/in wood Strips and plates, plasterboard, tiles, stone, granite, marble and metal surfaces
Montage/Einbau auf/in Holzleisten und -platten, Gipsplatten, Fliesen, Stein-, Granit-, Marmor- und Metalloberflächen



PL6

SURFACE | AUFBAU

flat | flach | LED Strips max. 12 mm

Silver/Silber
ANODIZED | ELOXIERT



max. 12 mm

max.
12 mm



OEM



The PL6 LED SURFACE Profile has a particularly narrow and flat design and is designed for LED flexstrips with a maximum width of 12 mm and is universally used in interior areas (in conjunction with the PL10 construction profile and cable universal duct also as a stand-alone LED pendant lamp with cord suspension or as LED lamp fixed with mounting brackets/springs). Use the profile for application-specific installations as a recess profile.

The LED profile covers opal/satinised (translucency 65 %) are made of shatter-proof, non-flammable polycarbonate (classification flammability UL94 V-2) and create homogeneous LED lighting conditions with high utilisation of the light output.

This LED SURFACE Profile can be fitted with three different plastic covers - flat, high or round cover. All three covers enclose the SURFACE profile on the open side. Thus only the LED light bar is visible. For all covers, the LED strips light in three directions (also on the side). The interior height (distance between LED chips and cover) is matched with the high and round cover for a continuous line of light - no pinpoints of light!

Covers also available in 6m length!

The PL6 LED SURFACE Profile is extremely flat and thus fits very well into the environment. This is ideally suited as a LED light source in residential and office furniture, home accessories, display cases, shelves and stairs and on walls and ceilings, among other things, due to their small dimensions and low weight.

Das PL6 LED AUFBAU-Profil hat ein besonders schmales und flaches Design, ist für LED Flexbänder mit einer maximalen Breite von 12 mm konzipiert und wird universell im Innenbereich (in Verbindung mit dem PL10 Aufbauprofil und Kabel-Universalkanal auch als eigenständige LED Hängeleuchte mit Seilabhängung oder als LED Leuchte fixiert mit Montageklammern/-federn) eingesetzt. Dieses Alu-Profil kann auch anwendungsspezifisch zum Einbau verwendet werden.

Die LED Profilabdeckungen Opal/satiniert (Lichtdurchlässigkeit 65 %) bestehen aus bruchsicherem und schwer brennbarem Polycarbonat (Klassifizierung Brennbarkeit UL94 V-2) und schaffen homogene LED Lichtverhältnisse mit hoher Verwertung der Lichtleistung. Dieses LED AUFBAU-Profil kann mit drei unterschiedlichen Kunststoffabdeckungen bestückt werden - flache, hohe oder runde Abdeckung. Alle drei Abdeckungen umschließen das AUFBAU-Profil an der offenen Seite. Somit ist nur noch die LED Lichtleiste sichtbar. Bei allen Abdeckungen leuchtet das Licht der LED Strips in drei Richtungen (auch seitlich). Die Innenhöhe (Abstand zwischen LED Chips und Abdeckung) ist bei der hohen und runden Abdeckung für eine durchgängige Lichtlinie abgestimmt - keine Lichtpunkte!

Abdeckungen auch in 6 m verfügbar!

Das PL6 LED AUFBAU-Profil ist ultraflach und fügt sich somit sehr gut in die Umgebungsbedingungen ein. Wegen der kleinen Abmessungen und des geringen Gewichtes ist es unter anderem als ideale LED Lichtquelle in Wohn- und Büromöbeln, Wohnaccessoires, Vitrinen, Regalen sowie an Treppenstufen, Wänden und Decken geeignet.

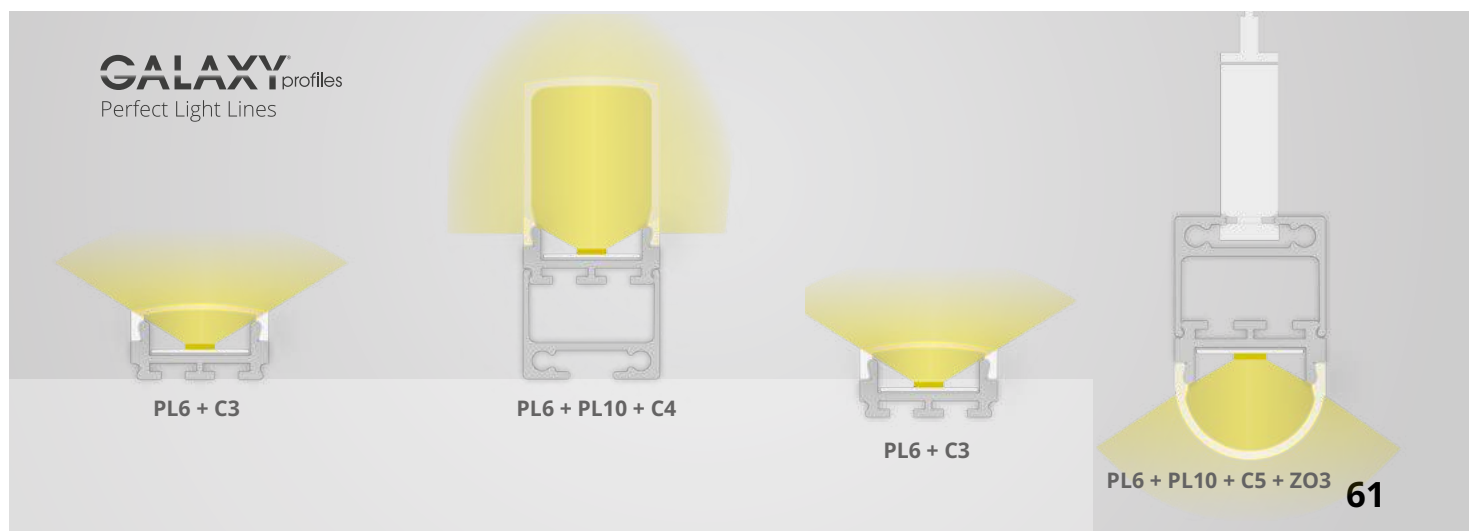

GALAXY profiles
Perfect Light Lines

PL6 + C3

PL6 + PL10 + C4

PL6 + C3

PL6 + PL10 + C5 + ZO3

61

- max. 12 mm
-
-
-
- OEM
-

GALAXY profiles
Perfect Light Lines

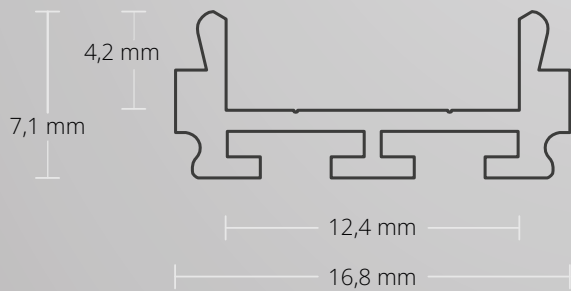
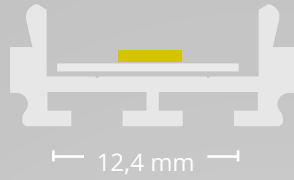

COVERS | ABDECKUNGEN

C3 65 %	200cm 8600005	300 cm 8600027	600 cm 8600038
C4 65 %	200 cm 8600006		
C5 65 %	200 cm 8600007		

END CAPS | ENDKAPPEN

E16	E16 8106068
C4	
E17	E17 8106063
E19	E19 8106067
C5	
E20	E20 8106168

PROFILE

PL6	200 cm 8106062		
	Z01 8106210 8106212 8106211		Z10 10 cm 8101085 200 cm 8101080
	Z12 8301506		Z13 8301507

LINEAR LED PENDANT LAMP | LINEARE LED HÄNGELEUCHE

PL10	200cm 8107012
E18	E118 8106064
C4	
E21	E21 8106130
C5	

	Z10 8301504		Z11 8301505
	Z05 8301501		
	Z03 8301502		Z03W 8301512
			Z03B 8301511

PL6 SURFACE | AUFBAU

high | hoch | LED Strips max. 12 mm

16,8 mm x 7,1 mm | 100 g/m

200 cm
8106062

Z01
Mounting Clips
Montageklammer
Sheet steel | Stahlblech
8106210
8106212
8106211

PL10.1
Mounting Profile
Montageprofil
10 cm 8101085
200 cm 8101080

Z12 | Z13
Connector | Verbinder
Steel | Stahl | 4 PCS/STK
Z12 | 180° 8301506
Z13 | 90° 8301507

max.
12 mm



OEM



COVERS | ABDECKUNGEN

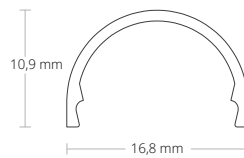
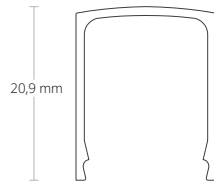
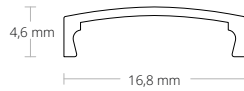

C3 opal | opal | 65 %
PC | 16,8 mm x 4,6 mm
200cm 8600005
300cm 8600027
600cm 8600038

C4 opal | opal | 65 %
PC | 16,8 mm x 20,9 mm
200cm 8600006

C5 opal | opal | 65 %
PC | 16,8 mm x 10,9 mm
200cm 8600007

END CAPS | ENDKAPPEN



E16 C4 PVC | 1 PCS/STK
E16 8106068



E17 C4 PVC | 1 PCS/STK | Cable/Kabel
E17 8106063



E19 C5 PVC | 1 PCS/STK
E19 8106067



E20 C5 PVC | 1 PCS/STK | Cable/Kabel
E20 8106168

max.
12 mm



OEM



LINEAR LED PENDANT LAMP | LINEARE LED HÄNGELEUCHTE



PL10 universal duct | Universalkanal
for cable | für Kabel

- 200cm **8107012**
- 200cm **8107013**
- 200cm **8107014**



E18 **C4** Alu | 2 PCS/STK

incl. screws | inkl. Schraube
8106064



E21 **C5** Alu | 2 PCS/STK

incl. screws | inkl. Schraube
8106130



Z10|Z11 Connector | Verbinder
Steel | Stahl | 4 PCS/STK

- Z10 | 180° **8301504**
- Z11 | 90° **8301505**



Z03 Hanging Wire System | Seilabhängung
Steel | Stahl | 1,5 m | Set | 75 kg

- Z03 **8301502**
- Z03W **8301512**
- Z03B **8301511**



Z05 Gripper | Gelenkgripper
Steel | Stahl | 2 PCS/STK

- Z05 **8301501**



max.
12 mm



OEM



PL8

RECESSED | EINBAU

200 cm | 300 cm

max. 12 mm

OEM



EXTENSION OF SERVICE LIFE
VERLÄNGERUNG LEBENSDAUER

MECHANICAL PROTECTION
MECHANISCHER SCHUTZ

COOLING
KÜHLUNG

HIGH LIGHT UTILISATION
HOHE LICHTVERWERTUNG

HOMOGENEOUS LIGHT
HOMOGENES LICHT

HOMOGENEOUS LIGHT with modular LED light solutions

- Wall, ceiling or floor mounting
Wand-, Decken- oder Bodenmontage
- Residential and office furniture
Wohn- und Büromöbel
- Furniture for business equipment
Möbel für Geschäftsausstattung
- Home accessories
Wohnaccessoires
- Cabinet doors | Schranktüren
- Display cases | Vitrinen
- Shelves | Regale
- Stairs and railings
Treppenstufen und -Geländer
- Balustrades | Balustraden
- Façades, balconies and terraces
Fassaden, Balkone und Terrassen
- Living spaces | Wohnräume
- Offices | Büroräume
- Hotel and gastronomy business
Hotellerie und Gastronomie
- Retail (shop and showcase windows)
Einzelhandel (Shop- und Schaufenster)
- Business areas and showrooms
Geschäftsflächen und Showrooms
- Barber / Beauty / body art studios
Friseur-/Beauty-/Body-Art-Studios
- Halls, foyers and corridors
Hallen, Foyers und Flure
- Wellness and indoor leisure facilities
Wellness- und Indoor-Freizeitanlagen
- Wet rooms | Nasszellen

Mounting/installation on/in wood Strips and plates, plasterboard, tiles, stone, granite, marble and metal surfaces
Montage/Einbau auf/in Holzleisten und -platten, Gipsplatten, Fliesen, Stein-, Granit-, Marmor- und Metalloberflächen



PL8

RECESSED | EINBAU

flat/wings | flach/Flügel | LED Strips max. 12 mm

 Silver/Silber
ANODIZED | ELOXIERT

 RAL 9010 White/Weiß
POWDER-COATED | PULVERBESCHICHTET

 RAL 9005 Black/Schwarz
POWDER-COATED | PULVERBESCHICHTET



max. 12 mm

max.
12 mm



OEM



PL8 LED RECESSED Profile has a particularly narrow design, is designed for LED flexstrips with a maximum width of 12 mm and is universally used in interior areas.

The LED profile covers opal/satinised (translucency 65 %), clear (translucency 85 %), white/matt (translucency 75 %) or black matt (translucency 25 %) are made of shatter-proof, non-flammable polycarbonate (classification flammability UL94 V-2) and create homogeneous LED lighting conditions with high utilisation of the light output.

Covers also available in 6m length!

These LED RECESSED Profiles are barely visible inserted/sunk in walls and ceilings with plaster, stone or concrete panels as well as wood panelling (optionally with the additional cable universal duct PL10) due to their small dimensions and low weight. They can be installed in pre-milled furniture. They are thus ideal LED light sources in residential and office furniture, home accessories, display cases, shelves, stairs and, of course, on walls and ceilings.

Das PL8 LED EINBAU-Profil hat ein besonders schmales Design, ist für LED Flexbänder mit einer maximalen Breite von 12mm konzipiert und wird universell im Innenbereich eingesetzt.

Die LED Profilabdeckungen Opal/satiniert (Lichtdurchlässigkeit 65 %), Klar (Lichtdurchlässigkeit 85 %), weiß/matt (Lichtdurchlässigkeit 75 %) oder Schwarz Matt (Lichtdurchlässigkeit 25 %) bestehen aus bruchsicherem und schwer brennbarem Polycarbonat (Klassifizierung Brennbarkeit UL94 V-2) und schaffen homogene LED Lichtverhältnisse mit hoher Verwertung der Lichtleistung.

Abdeckungen auch in 6 m verfügbar!

Diese LED EINBAU-Profile werden aufgrund ihrer kleinen Abmessungen und des geringen Gewichtes in Wänden und Decken mit Gips-, Stein- oder Betonplatten sowie Holzverkleidungen (optional mit dem zusätzlichen Kabel-Universalkanal PL10) kaum sichtbar versenkt. Sie können auch in vorgefräste Möbel installiert werden. Sie sind somit ideale LED Lichtquellen in Wohn- und Büromöbeln, Wohnaccessoires, Vitrinen, Regalen, an Treppenstufen und selbstverständlich an Wänden und Decken.

GALAXY profiles
Perfect Light Lines



max.
12 mm

OEM



GALAXY profiles
Perfect Light Lines

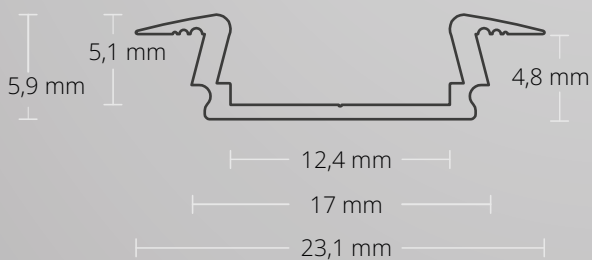
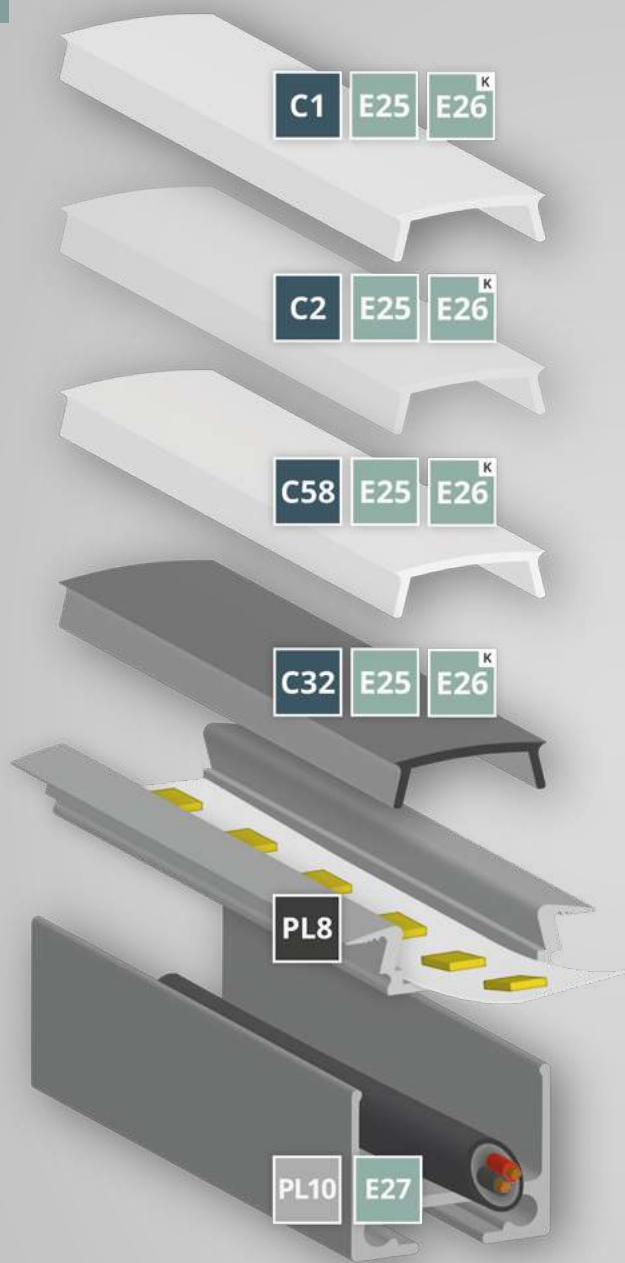
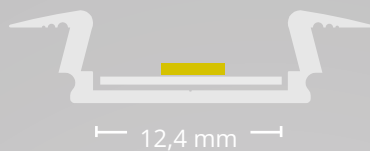

COVERS | ABDECKUNGEN





C1 65 %	200cm 8600004	250 cm 8600026	300 cm 8600080	600 cm 8600037
C2 85 %	200 cm 8600003	250 cm 8600135	300 cm 8600136	
C58 75 %	200 cm 8600154			
C32 25 %	200 cm 8600070	300 cm 8600103	600 cm 8600071	

END CAPS | ENDKAPPEN

E25	E25 8106085	E25 8106086	E25 8106087
E26	E26 8106080	E25 8106083	E25 8106084

PROFILE

PL8	200 cm 8106082	200 cm 8106088	200cm 8106089
	300 cm 8106182		300cm 8106189

	Z01 8106210 8106212 8106211		PL10.1 10 cm 8101085 200 cm 8101080
	Z61 8123554 8123555 8123556		Z62 8192287

**LINEAR LED PENDANT LAMP |
LINEARE LED HÄNGELEUCHTE**

PL10	200cm 8107012	200cm 8107013	200cm 8107014
E27	E27 8106045		

	Z10 8301504		Z11 8301505
---	----------------	---	----------------

PL8 RECESSED | EINBAU

flat/wings | flach/Flügel | LED Strips max. 12 mm
23,1 mm x 5,9 mm | 82 g/m

200 cm **8106082** 300 cm **8106182** 200 cm **8106088** 200 cm **8106089** 300 cm **8106189**

Z01 Mounting Clips
Montageklammer
8106210
8106212
8106211

PL10.1 Mounting Profile
Montageprofil
10 cm **8101085**
200 cm **8101080**

Z61 **NEW** Mounting Clips swivelling
Montageklammer schwenkbar
8123554
8123555
8123556

Z62 **NEW** Mounting Clips with extension spring
Montageklammer mit Zugfeder
Spring steel | Federstahl
8192287

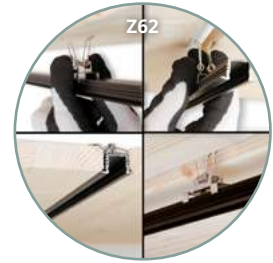

max.
12 mm

OEM



COVERS | ABDECKUNGEN

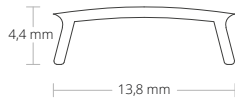

C1 opal | opal | 65 %
PC | 13,8 mm x 4,4 mm
200cm **8600004** 250cm **8600026** 300cm **8600080** 600cm **8600037**

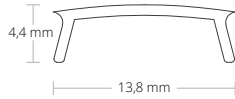

C2 clear | klar | 85 %
PC | 13,8 mm x 4,4 mm
200cm **8600003** 250cm **8600135** 300cm **8600136**

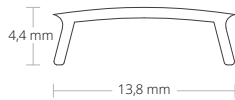

C58 white/matt | weiß/matt | 75 %
PC | 13,8 mm x 4,4 mm
200cm **8600154**



C32 black/matt | schwarz/matt | 25 %
PC | 13,81 mm x 4,4 mm
200cm **8600070** 300cm **8600103** 600cm **8600071**

END CAPS | ENDKAPPEN



E25 PVC | 1 PCS/STK
E25 **8106085** E25 **8106086** E25 **8106087**



E26 PVC | 1 PCS/STK | Cable/Kabel
E26 **8106080** E25 **8106083** E25 **8106084**

LINEAR LED PENDANT LAMP | LINEARE LED HÄNGELEUCHE



PL10 universal duct | Universalkanal
for cable | für Kabel
200cm **8107012** 200cm **8107013** 200cm **8107014**



E27 Alu | 2 PCS/STK
incl. screws | inkl. Schraube
8106045



Z10|Z11 Connector | Verbinder
Steel | Stahl | 4 PCS/STK
Z10 | 180° **8301504** Z11 | 90° **8301505**



Z03 Hanging Wire System | Seilabhängung
Steel | Stahl | 1,5 m | Set | 75 kg
Z03 **8301502** Z03W **8301512** Z03B **8301511**



Z05 Gripper | Gelenkgripper
Steel | Stahl | 2 PCS/STK
Z05 **8301501**

PL10

200 cm

OEM

PL10.1

200 cm | 10 cm

OEM

MOUNTING | MONTAGE

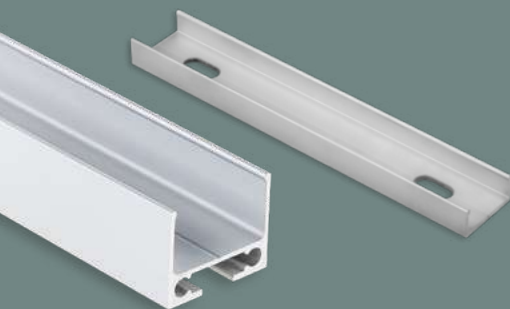

EXTENSION OF SERVICE LIFE
VERLÄNGERUNG LEBENSDAUER

MECHANICAL PROTECTION
MECHANISCHER SCHUTZ

COOLING
KÜHLUNG

HIGH LIGHT UTILISATION
HOHE LICHTVERWERTUNG

HOMOGENEOUS LIGHT
HOMOGENES LICHT

HOMOGENEOUS LIGHT with modular LED light solutions

- Wall, ceiling or floor mounting
Wand-, Decken- oder Bodenmontage
- Living spaces | Wohnräume
- Offices | Büroräume
- Hotel and gastronomy business
Hotellerie und Gastronomie
- Retail (shop and showcase windows)
Einzelhandel (Shop- und Schaufenster)
- Business areas and showrooms
Geschäftsflächen und Showrooms
- Barber / Beauty / body art studios
Friseur-/Beauty-/Body-Art-Studios
- Halls, foyers and corridors
Hallen, Foyers und Flure
- Wellness and indoor leisure facilities
Wellness- und Indoor-Freizeitanlagen
- Wet rooms | Nasszellen
- Commercial premises (e.g. hair salons)
Gewerbliche Dienstleistungsräumlichkeiten (z. B. Friseursalons etc.)
- Technology and supply rooms
Technik- und Versorgungsräume

Mounting/installation on/in wood Strips and plates, plasterboard, tiles, stone, granite, marble and metal surfaces
Montage/Einbau auf/in Holzleisten und -platten, Gipsplatten, Fliesen, Stein-, Granit-, Marmor- und Metalloberflächen

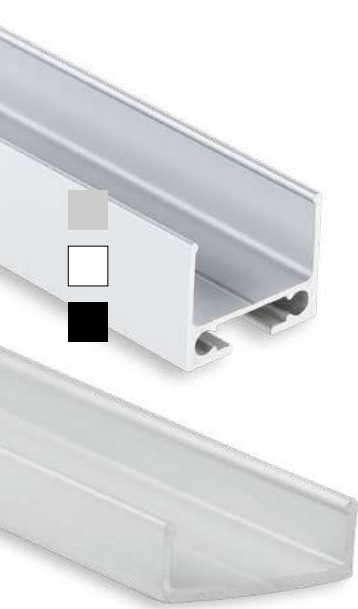

PL10 | PL10.1

MOUNTING | MONTAGE

 Silver/Silber
ANODIZED | ELOXIERT

 RAL 9010 White/Weiß
POWDER-COATED | PULVERBESCHICHTET

 RAL 9005 Black/Schwarz
POWDER-COATED | PULVERBESCHICHTET



The **PL10 LED SURFACE Profile** has a narrow and flat design and is designed as a universal cable duct for PL series aluminium profiles. The PL10 LED SURFACE Profile is connected via a click in system to stand-alone linear LED lighting systems.

These stand-alone linear LED lighting systems by GALAXY® profiles are equipped with the corresponding LED strips depending on the requirement and can be used as

- general room lighting (direct or indirect LED lighting),
- staged LED decorative lighting,
- mood ambient LED effect lighting or also for
- the object saving LED shop, display cases/shop window lighting.

In the hotel and gastronomy business, linear LED lighting systems create a welcoming and pleasant atmosphere for the guests. In the work areas, foyers, corridors and technology/supply rooms, they offer the employees sufficient brightness for a safe and accident-free work.

The **PL10.1 LED MOUNTING Profile** is 200cm long as standard (also comes in 10cm including drill holes) and is made from high-quality aluminium (anodised). The PL10.1 features a slim, flat design and can be used as a mounting tool for all profiles in the PL range. The PL10.1 is connected with the profiles using a click system.

Special features: the PL10.1 is very flat and combines with the LED profiles to create a compact unit.

Das **PL10 LED AUFBAU-Profil** hat ein schmales und flaches Design und ist als Kabel-Universalkanal für Aluminiumprofile konzipiert. Das PL10 LED AUFBAU-Profil wird mit Profilen der PL Serie per Klicksystem zu eigenständigen Linearen LED Leuchtensystemen verbunden.

Diese eigenständigen Linearen LED Leuchtensysteme von GALAXY® profiles werden je nach Anforderung mit den entsprechenden LED Strips bestückt und können als

- allgemeine Raumbeleuchtung (direkte oder indirekte LED Beleuchtung),
- inszenierende LED Dekorbeleuchtung,
- stimmunggebende LED Effektbeleuchtung oder auch für
- die objektschonende LED Shop-, Vitrinen-/Schaufensterbeleuchtung eingesetzt werden.

In Hotellerie und Gastronomie schaffen Lineare LED Leuchtensysteme eine einladende, wohlige Atmosphäre für die Gäste. In den Arbeitsbereichen, Foyers, Fluren und Technik-/Versorgungsräumen bieten sie den Angestellten ausreichend Helligkeit für ein sicheres und unfallfreies Arbeiten.

Das **PL10.1 LED MONTAGE-Profil** hat eine Standardlänge von 200 cm (wird auch in 10 cm inkl. Bohrlöcher geliefert) und wird aus qualitativ hochwertigem Aluminium (eloxiert) gefertigt. Das PL10.1 hat ein schmales und flaches Design und dient als Montagewerkzeug für alle Profile der PL-Serie. Das PL10.1 wird per Klicksystem mit den Profilen verbunden.

Besonderheit: das PL10.1 ist sehr flach und bildet eine kompakte Einheit mit den LED Profilen.

GALAXY profiles
Perfect Light Lines

APPLICATION EXAMPLES
ANWENDUNGSBEISPIELE

PL2 + PL10 + C1

PL8 + PL10 + C32

PN10 + PN33 + PL10.1

PL6 + PL10 + C5 + ZO3

71

GALAXY profiles
Perfect Light Lines

15,4 mm



OEM

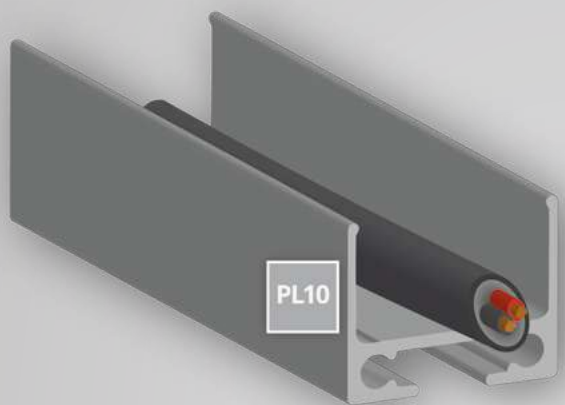

PROFILE

PL10 200cm 8107012 200cm 8107013 200cm 8107014

Z10 8301504

Z11 8301505

Z05 8301501

Z53 8123401

Z03 8301502

Z03W 8301512 Z03B 8301511

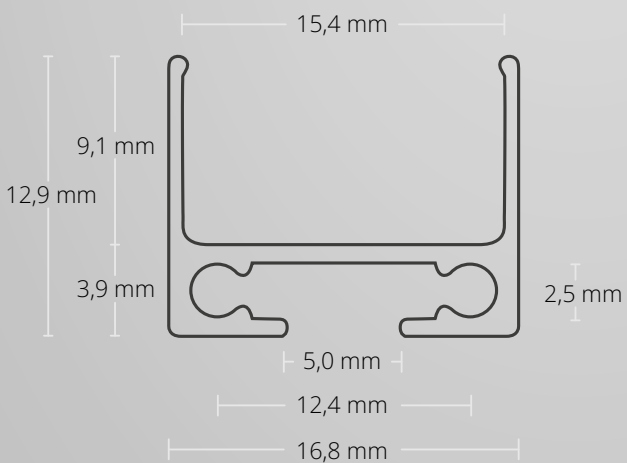



PL10 MOUNTING | MONTAGE

16,8 mm x 12,9 mm | 131 g/m

200 cm **8107012** 200 cm **8107013** 200 cm **8107014**

For use as a linear LED pendant lamp, the LED aluminium profile is connected to the PL10 LED SETUP profile / cable universal channel using a click system and is affixed to the ceiling with the corresponding cable suspension. You will find the corresponding accessories here.

Für den Einsatz als Lineare LED Hängeleuchte wird das LED Alu-Profil mit dem PL10 LED AUFBAU-Profil/Kabel-Universalkanal per Klicksystem verbunden und mit der entsprechenden Seilabhangung an der Decke fixiert. Hier finden Sie das entsprechende Zubehor.



CONNECTOR | VERBINDER

High-quality connectors in a set of 4, for better alignment of the LED profile. They can be pushed in the profile and will be fixed with the grub screw.

Hochwertige Verbinder im Set mit 4 Stuck, zum professionellen ausrichten der LED Profile. Sie konnen in das Profil geschoben werden und anschlieend mit der Madenschraube fixiert werden.

Z10|Z11 Connector | Verbinder
Steel | Stahl | 4 PCS/STK
Z10 | 180° Z11 | 90°
8301504 **8301505**

Z53 Connector | Verbinder
flexibel 180°- 45° | 2PCS/STK
Steel | Stahl
8123401



LINEAR LED PENDANT LAMP | LINEARE LED HANGELEUCHTE

Wire suspension with PVC-sheathed steel wires for the professional installation of the PL10 LED SURFACE profile / universal cable channel - max. capacity 75 kg. For demanding installation on sloping ceilings (ceiling canopy), the joint gripper is used in addition to the wire suspension.

Seilabhangung mit PVC-ummantelten Stahlseilen fur die professionelle Installation des PL10 LED AUFBAU-Profil/Kabel-Universalkanals - max. Tragkraft 75 kg. Fur die anspruchsvolle Montage an schragen Decken (Deckenbaldachin) wird erganzend zur Seilabhangung der Gelenkgripper verwendet.

Z03 Hanging Wire System | Seilabhangung
Steel | Stahl | 1,5 m | Set | 75 kg
Z03 Z03W Z03B
8301502 **8301512** **8301511**

Z05 Gripper | Gelenkgripper
Steel | Stahl | 2 PCS/STK
Z05
8301501



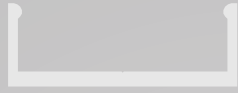

**MOUNTING PROFILE
MONTAGEPROFIL**

PL10.1  200cm
8101080

 10cm
8101085

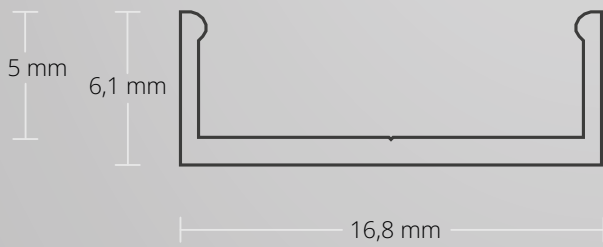
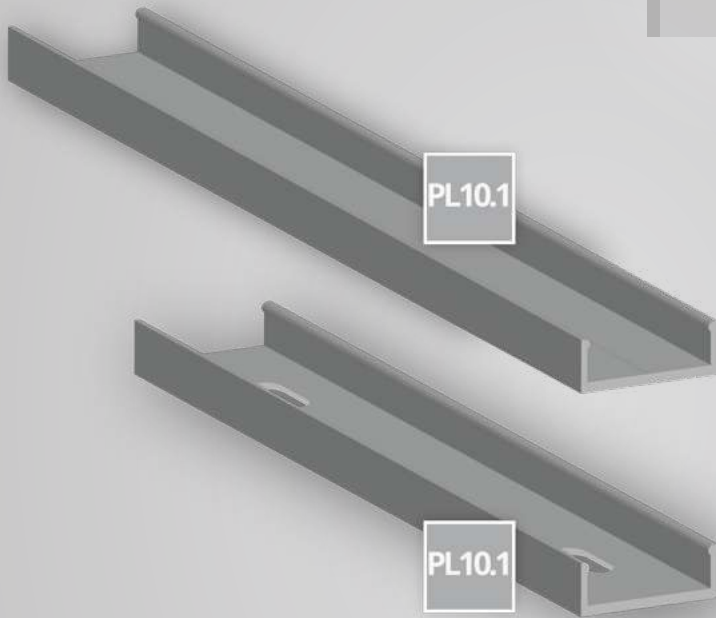

PL10.1

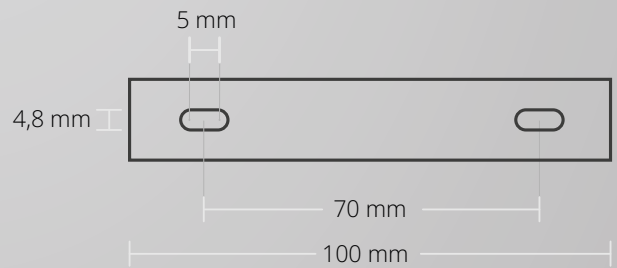

PL10.1 - 10 cm



PL10.1

Mounting Profile | Montageprofil
16,8 mm x 6,1 mm | 70 g/m

200 cm
8101080



FIXING BAR | BEFESTIGUNGSLEISTE

16,8 mm x 6,1 mm
10 cm including drill holes | 10 cm inkl. Bohrlöcher

10 cm
8101085



PL11

CORNER | ECK

200 cm

max. 12 mm

OEM



EXTENSION OF SERVICE LIFE
VERLÄNGERUNG LEBENSDAUER

MECHANICAL PROTECTION
MECHANISCHER SCHUTZ

COOLING
KÜHLUNG

HIGH LIGHT UTILISATION
HOHE LICHTVERWERTUNG

HOMOGENEOUS LIGHT
HOMOGENES LICHT

HOMOGENEOUS LIGHT with modular LED light solutions

- Wall, ceiling or floor mounting
Wand-, Decken- oder Bodenmontage
- Residential and office furniture
Wohn- und Büromöbel
- Furniture for business equipment
Möbel für Geschäftsausstattung
- Home accessories
Wohnaccessoires
- Mirrors | Spiegel
- Cabinet doors | Schranktüren
- Display cases | Vitrinen
- Shelves | Regale
- Stairs and railings
Treppenstufen und -Geländer
- Balustrades | Balustraden
- Façades, balconies and terraces
Fassaden, Balkone und Terrassen
- Living spaces | Wohnräume
- Offices | Büroräume
- Hotel and gastronomy business
Hotellerie und Gastronomie
- Retail (shop and showcase windows)
Einzelhandel (Shop- und Schaufenster)
- Business areas and showrooms
Geschäftsflächen und Showrooms
- Barber / Beauty / body art studios
Friseur-/Beauty-/Body-Art-Studios
- Halls, foyers and corridors
Hallen, Foyers und Flure
- Wellness and indoor leisure facilities
Wellness- und Indoor-Freizeitanlagen
- Wet rooms | Nasszellen

Mounting/installation on/in wood Strips and plates, plasterboard, tiles, stone, granite, marble and metal surfaces
Montage/Einbau auf/in Holzleisten und -platten, Gipsplatten, Fliesen, Stein-, Granit-, Marmor- und Metalloberflächen



PL11

CORNER | ECK

LED Strips max. 12 mm

Silver/Silber
ANODIZED | ELOXIERT



max. 12 mm

max.
12 mm



OEM



The PL11 LED CORNER profile is designed for LED flex-strips with a maximum width of 12 mm and is universally used in interior areas.

The LED profile cover opal/satinised (translucency 65 %) is made of shatter-proof, non-flammable polycarbonate (classification flammability UL94 V-2) and creates homogeneous LED lighting conditions with high utilisation of the light output (no pinpoint of light, but rather a continuous line of light).

The PL11 LED CORNER profile is dimensioned small and is ideally suited as a LED light source in residential and office furniture, home accessories, display cases as well as shelves, walls and ceilings, among other things, due to its low weight. Each room receives the desired quality of the light.

Das PL11 LED ECK-Profil ist für LED Flexbänder mit einer maximalen Breite von 12 mm konzipiert und wird universell im Innenbereich eingesetzt.

Die LED Profilabdeckung Opal/satiniert (Lichtdurchlässigkeit 65%) besteht aus bruchsicherem und schwer brennbarem Polycarbonat (Klassifizierung Brennbarkeit UL94V-2) und schafft homogene LED Lichtverhältnisse mit hoher Verwertung der Lichtleistung (keine Lichtpunkte, sondern durchgängige Lichtlinie).

Das PL11 LED ECK-Profil ist klein dimensioniert und aufgrund des geringen Gewichtes unter anderem als ideale LED Lichtquelle in Wohn- und Büromöbeln, Wohnaccessoires, Vitrinen sowie an Regalen, Wänden und Decken geeignet. Jeder Raum erhält die gewünschte Lichtqualität.

GALAXY profiles
Perfect Light Lines

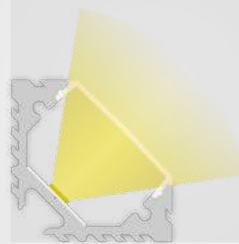

PL11 + C7

- max. 12 mm
- OEM
- Water drop icon

GALAXY profiles
Perfect Light Lines

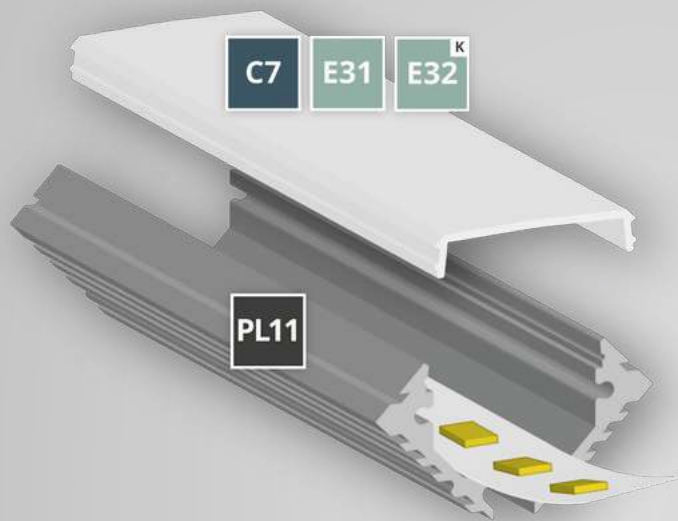
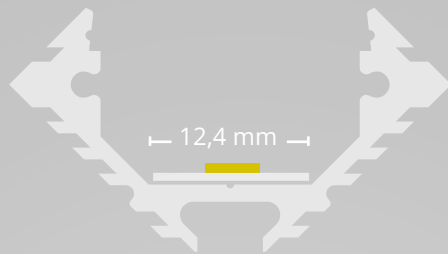

COVERS | ABDECKUNGEN

C7 65 % 200cm
8600009

END CAPS | ENDKAPPEN

E31 E31
8108016

E32 E32
8108011

PROFILE

PL11 200 cm
8108012

Z01
8106210
8106212
8106211

Z22
8301508

Z23
8301509

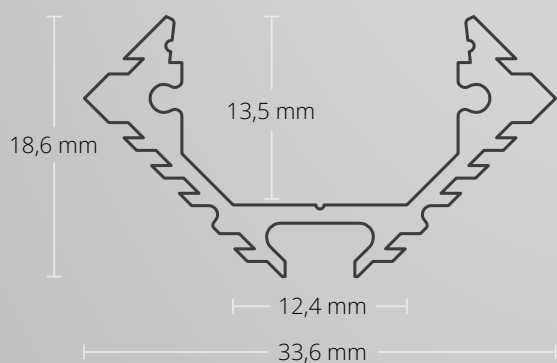



PL11 CORNER | ECK

LED Strips max. 12 mm
33,6 mm x 18,6 mm | 321 g/m

200 cm
8108012



Z01
Mounting Clips
Montageklammer
Sheet steel | Stahlblech



8106210
8106212
8106211



Z22 | Z23
Connector | Verbinder
Steel | Stahl | 4 PCS/STK



Z22 | 180° **8301508**
Z23 | 90° **8301509**

max.
12 mm



OEM



COVERS | ABDECKUNGEN

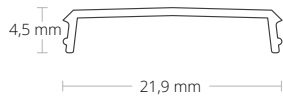

C7 opal | opal | 65 %
PC | 21,9 mm x 4,5 mm
200cm
8600009

END CAPS | ENDKAPPEN



E31 PVC | 1 PCS/STK

E31
8108016



E32 PVC | 1 PCS/STK | Cable/Kabel

E32
8108011

PL13

LUMINAIRE | LEUCHE

200 cm

max. 12 mm

OEM



EXTENSION OF SERVICE LIFE
VERLÄNGERUNG LEBENSDAUER

MECHANICAL PROTECTION
MECHANISCHER SCHUTZ

COOLING
KÜHLUNG

HIGH LIGHT UTILISATION
HOHE LICHTVERWERTUNG

HOMOGENEOUS LIGHT
HOMOGENES LICHT

HOMOGENEOUS LIGHT with modular LED light solutions

- Homes
Wohnräume
- Offices, conference and presentation rooms
Büro-, Konferenz- und Präsentationsräume
- Waiting rooms
Ordnationen
- Business premises and sales floors
Geschäfts- und Verkaufsflächen
- Showrooms
- Hotel and gastronomy
Hotellerie und Gastronomie
- Foyers, corridors and connecting rooms
Foyers, Flure und Verbindungsräume
- Waiting and common rooms
Warte- und Aufenthaltsräume
- Commercial premises (e.g. hair salons)
Gewerbliche Dienstleistungsräumlichkeiten (z. B. Friseursalons etc.)

Mounting/installation on/in wood Strips and plates, plasterboard, tiles, stone, granite, marble and metal surfaces
Montage/Einbau auf/in Holzleisten und -platten, Gipsplatten, Fliesen, Stein-, Granit-, Marmor- und Metalloberflächen



PL13

LUMINAIRE | LEUCHE

UP & DOWN | LED Strips max. 12 mm

Silver/Silber
POWDER-COATED
PULVERBESCHICHTET

RAL 9003 White/Weiß
POWDER-COATED
PULVERBESCHICHTET

RAL 9005 Black/Schwarz
POWDER-COATED
PULVERBESCHICHTET



max. 12 mm

max.
12 mm



OEM



Countless light options in a timeless design!

The PL13 LED LIGHT Profile UP & DOWN is 200cm long as standard and is available in white and black. It is made from high-quality aluminium (anodised) and designed for use as an independent light for wall and ceiling mounting. It is fixed using the PL10.1 mounting profile.

Two LED flex strips up to 12mm in width each can be fixed to the back with adhesive - to emit light in two directions! The large body is excellent at letting the heat from the LEDs dissipate. This means that very powerful LED flex strips can be installed. The LED profile covers opal/satinised (translucency 65 %), clear (translucency 85 %), white/matt (translucency 75 %) or black matt (translucency 25 %) are made from shatterproof, flame-retardant polycarbonate (classification flammability UL94 V-2). Aluminium end caps can be professionally and securely screwed to the side of this light profile, allowing it to be mounted to walls as well as ceilings.

Covers also available in 6m length!

The result is unified light and a high transfer of the light output!

Unzählige Lichtszenen in zeitlosem Design!

Das PL13 LED LEUCHTEN-Profil UP & DOWN wird standardmäßig mit einer Länge von 200 cm geliefert und ist in den Farben weiß und schwarz verfügbar. Es ist aus hochwertigem Aluminium (eloxiert) gefertigt und wurde für den Einsatz als eigenständige Leuchte für die Wand- und Deckenmontage konzipiert. Es wird mit dem Montageprofil PL10.1 fixiert.

Rückseitig können zwei LED Flexbänder mit je 12 mm max. Breite eingeklebt werden – Lichtabstrahlung in zwei Richtungen! Der große Korpus leitet die Wärme der LEDs hervorragend ab. Es können somit auch sehr starke LED Flexbänder installiert werden. Die LED Profilabdeckungen Opal/satiniert (Lichtdurchlässigkeit 65 %), Klar (Lichtdurchlässigkeit 85 %), weiß/matt (Lichtdurchlässigkeit 75 %) oder Schwarz Matt (Lichtdurchlässigkeit 25 %) bestehen aus bruch sicherem und schwer brennbarem Polycarbonat (Klassifizierung Brennbarkeit UL94 V-2).

Seitlich wird dieses Leuchten-Profil mit ALU-Endkappen professionell und sicher verschraubt und kann sowohl an Wänden als auch an Decken angebracht werden.

Abdeckungen auch in 6 m verfügbar!

Homogene Lichtverhältnisse und hohe Verwertung der Lichtleistung sind das Ergebnis!

GALAXY profiles
Perfect Light Lines

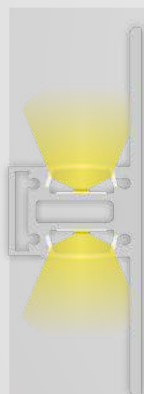

PL13 + C2 + PL10.1



PL13 + C32 + PL10.1

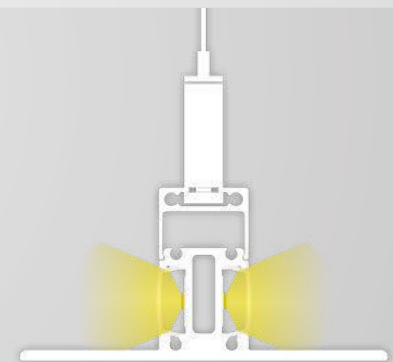

PL13 + C2 + PL10 + Z03W

12,4 mm 12,4 mm

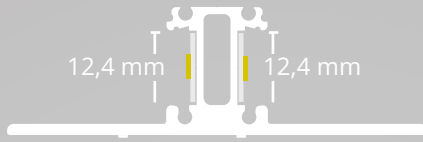

max.
12 mm

OEM

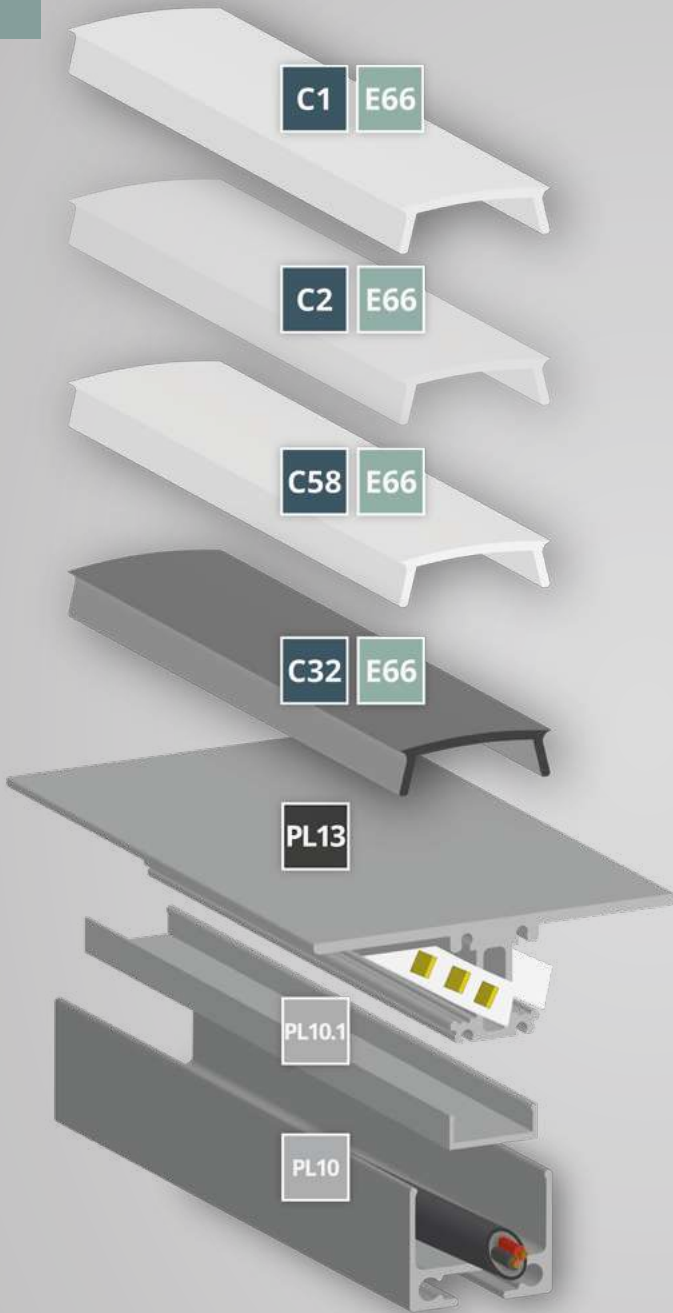

COVERS | ABDECKUNGEN

C1 65 % 200cm **8600004** 250 cm **8600026** 300 cm **8600080** 600 cm **8600037**

C2 85 % 200 cm **8600003** 250 cm **8600135** 300 cm **8600136**

C58 75 % 200 cm **8600154**

C32 25 % 200 cm **8600070** 300 cm **8600103** 600 cm **8600071**

END CAPS | ENDKAPPEN

E66 E66 **8101005** E66 **8101006** E66 **8101007**

PROFILE

PL13 200 cm **8101004** 200 cm **8101003** 200cm **8101002**

PL10.1
10 cm **8101085**
200 cm **8101080**

LINEAR LED PENDANT LAMP | LINEARE LED HÄNGELEUCHE

PL10 200cm **8107012** 200cm **8107013** 200cm **8107014**

Z10 **8301504** **Z11** **8301505**

Z05 **8301501**

Z03 **8301502** **Z03W** **8301512** **Z03B** **8301511**

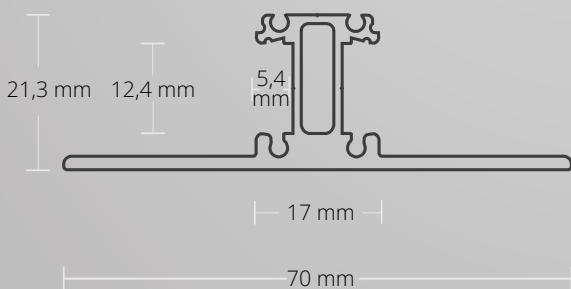



PL13 LUMINAIRE | LEUCHE

UP & DOWN | LED Strips max. 12 mm
70,0 mm x 21,3 mm | 623 g/m

- 200 cm **8101004**
- 200 cm **8101003**
- 200 cm **8101002**



PL10.1

Mounting Profile
Montageprofil

- 10 cm **8101085**
- 200 cm **8101080**

max.
12 mm

OEM

COVERS | ABDECKUNGEN



C1 opal | opal | 65 %

PC | 13,8 mm x 4,4 mm

- 200cm **8600004**
- 250cm **8600026**
- 300cm **8600080**
- 600cm **8600037**



C2 clear | klar | 85 %

PC | 13,8 mm x 4,4 mm

- 200cm **8600003**
- 250cm **8600135**
- 300cm **8600136**

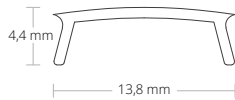

C58 white/matt | weiß/matt | 75 %

PC | 13,8 mm x 4,4 mm

- 200cm **8600154**



C32 black/matt | schwarz/matt | 25 %

PC | 13,81 mm x 4,4 mm

- 200cm **8600070**
- 300cm **8600103**
- 600cm **8600071**

END CAPS | ENDKAPPEN



E66 ALU | 1 PCS/STK

- E66 **8101005**
- E66 **8101006**
- E66 **8101007**

LINEAR LED PENDANT LAMP | LINEARE LED HÄNGELEUCHE



PL10 universal duct | Universalkanal
for cable | für Kabel

- 200cm **8107012**
- 200cm **8107013**
- 200cm **8107014**



Z10|Z11 Connector | Verbinder

Steel | Stahl | 4 PCS/STK

- Z10 | 180° **8301504**
- Z11 | 90° **8301505**



Z03 Hanging Wire System | Seilabhängung

Steel | Stahl | 1,5 m | Set | 75 kg

- Z03 **8301502**
- Z03W **8301512**
- Z03B **8301511**



Z05 Gripper | Gelenkgripper

Steel | Stahl | 2 PCS/STK

- Z05 **8301501**

P05

CORNER | ECK

200 cm

max. 12 mm

OEM

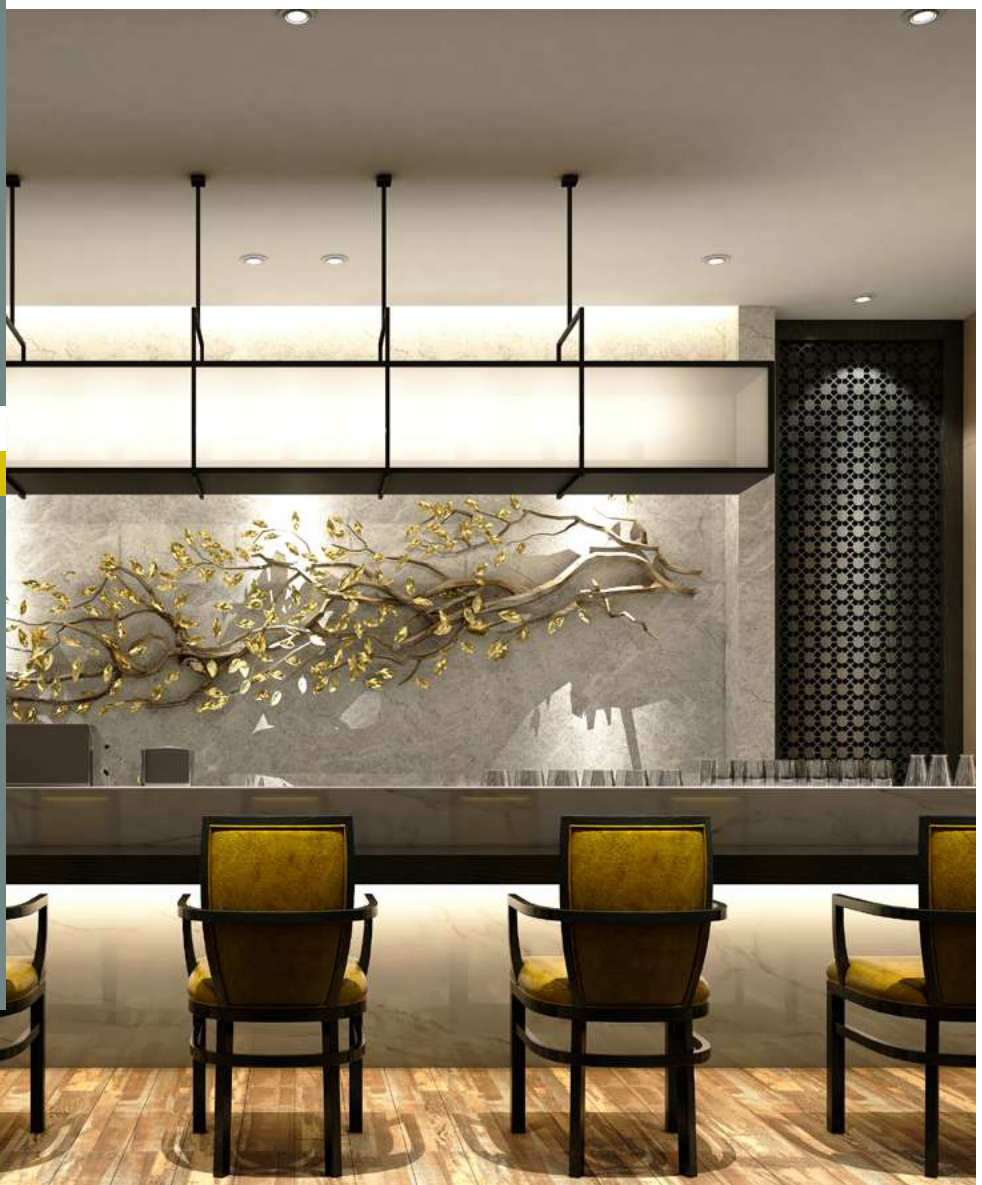

EXTENSION OF SERVICE LIFE
VERLÄNGERUNG LEBENSDAUER

MECHANICAL PROTECTION
MECHANISCHER SCHUTZ

COOLING
KÜHLUNG

HIGH LIGHT UTILISATION
HOHE LICHTVERWERTUNG

HOMOGENEOUS LIGHT
HOMOGENES LICHT

HOMOGENEOUS LIGHT with modular LED light solutions

- Wall, ceiling or floor mounting
Wand-, Decken- oder Bodenmontage
- Residential and office furniture
Wohn- und Büromöbel
- Furniture for business equipment
Möbel für Geschäftsausstattung
- Home accessories
Wohnaccessoires
- Mirrors | Spiegel
- Cabinet doors | Schranktüren
- Display cases | Vitrinen
- Shelves | Regale
- Stairs
Treppenstufen
- Balustrades | Balustraden
- Façades, balconies and terraces
Fassaden, Balkone und Terrassen
- Living spaces | Wohnräume
- Offices | Büroräume
- Hotel and gastronomy business
Hotellerie und Gastronomie
- Retail (shop and showcase windows)
Einzelhandel (Shop- und Schaufenster)
- Business areas and showrooms
Geschäftsflächen und Showrooms
- Barber / Beauty / body art studios
Friseur-/Beauty-/Body-Art-Studios
- Halls, foyers and corridors
Hallen, Foyers und Flure
- Wellness and indoor leisure facilities
Wellness- und Indoor-Freizeitanlagen
- Wet rooms | Nasszellen

Mounting/installation on/in wood Strips and plates, plasterboard, tiles, stone, granite, marble and metal surfaces
Montage/Einbau auf/in Holzleisten und -platten, Gipsplatten, Fliesen, Stein-, Granit-, Marmor- und Metalloberflächen



PO5

CORNER | ECK

LED Strips max. 12 mm

Silver/Silber
ANODIZED | ELOXIERT



max. 12 mm

max.
12 mm



OEM



The PO5 LED CORNER profile is designed for LED strips with a maximum width of 12 mm and is used universally in interiors.

The LED profile cover opal/satinised (light transmission 65 %) is made of shatterproof and flame-retardant polycarbonate (flammability classification UL94 V-2) and creates homogeneous LED lighting conditions with high utilisation of the light output (no light points but continuous light lines).

An essential feature of this profile system is the flush closure. The viewer only sees the LED light bar (no aluminium is visible).

The PO5 LED CORNER profile is small in size and due to the low weight, among other uses, is also ideally suited as a LED light source in residential and office furniture, living accessories, display windows as well as on shelves, walls and ceilings. The clever product design allows for installation in all corners.

Das PO5 LED ECK-Profil ist für LED Flexbänder mit einer maximalen Breite von 12 mm konzipiert und wird universell im Innenbereich eingesetzt.

Die LED Profilabdeckung Opal/satiniert (Lichtdurchlässigkeit 65 %) besteht aus bruchsicherem und schwer brennbarem Polycarbonat (Klassifizierung Brennbarkeit UL94 V-2) und schafft homogene LED Lichtverhältnisse mit hoher Verwertung der Lichtleistung (keine Lichtpunkte, sondern durchgängige Lichtlinien).

Eine wesentliche Besonderheit dieses Profilsystems ist der bündige Abschluss. Der Betrachter nimmt nur noch die LED Lichtleiste wahr (kein Aluminium sichtbar).

Das PO5 LED ECK-Profil ist klein dimensioniert und aufgrund des geringen Gewichtes unter anderem als ideale LED Lichtquelle in Wohn- und Büromöbeln, Wohnaccessoires, Vitrinen sowie an Regalen, Wänden und Decken geeignet. Das durchdachte Produktdesign ermöglicht die Montage in allen Ecken.

GALAXY profiles
Perfect Light Lines

PO5 + C45

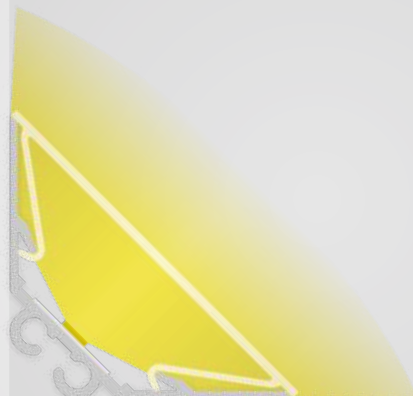

max.
12 mm

OEM

GALAXY profiles
Perfect Light Lines



COVERS | ABDECKUNGEN

C45 65 % 200cm
8600097

C46 75 % 200cm
8600098

END CAPS | ENDKAPPEN

E84 E84
8123150

PROFILE

PO5 200 cm
8123100

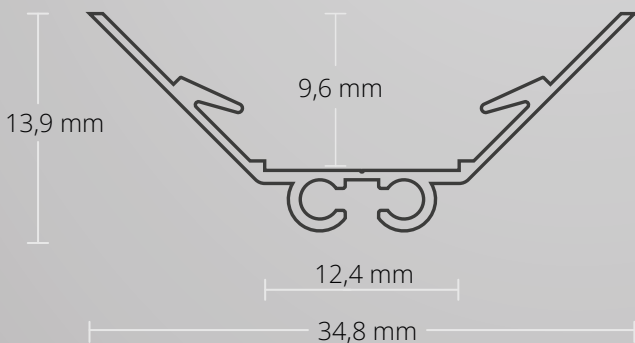
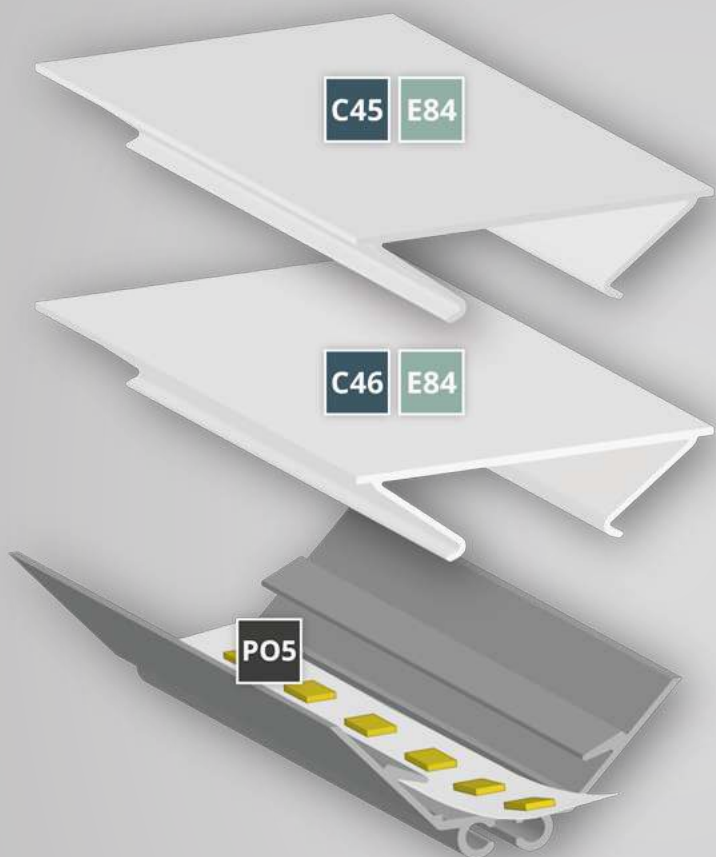



PO5 CORNER | ECK

LED Strips max. 12 mm
34,8 mm x 13,9 mm | 107 g/m

200 cm
8123100

max.
12 mm



OEM



COVERS | ABDECKUNGEN

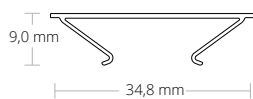

C45 opal | opal | 65 %
PC | 34,8 mm x 9,0 mm
200cm
8600097



C46 white matt/weiß matt | 75 %
PC | 34,8 mm x 9,0 mm
200cm
8600098

END CAPS | ENDKAPPEN



E84 Aluminium | 2 PCS/STK
incl. screws | inkl. Schraube

E84
8123150

P013

SURFACE | AUFBAU

200 cm

max. 15 mm

OEM



EXTENSION OF SERVICE LIFE
VERLÄNGERUNG LEBENSDAUER

MECHANICAL PROTECTION
MECHANISCHER SCHUTZ

COOLING
KÜHLUNG

HIGH LIGHT UTILISATION
HOHE LICHTVERWERTUNG

HOMOGENEOUS LIGHT
HOMOGENES LICHT

HOMOGENEOUS LIGHT with modular LED light solutions

- Wall, ceiling or floor mounting
Wand-, Decken- oder Bodenmontage
- Residential and office furniture
Wohn- und Büromöbel
- Furniture for business equipment
Möbel für Geschäftsausstattung
- Mirrors | Spiegel
- Cabinet doors | Schranktüren
- Display cases | Vitrinen
- Shelves | Regale
- Stairs and railings
Treppenstufen und -Geländer
- Balustrades | Balustraden
- Living spaces | Wohnräume
- Offices | Büroräume
- Hotel and gastronomy business
Hotellerie und Gastronomie
- Retail (shop and showcase windows)
Einzelhandel (Shop- und Schaufenster)
- Business areas and showrooms
Geschäftsflächen und Showrooms
- Barber / Beauty / body art studios
Friseur-/Beauty-/Body-Art-Studios
- Halls, foyers and corridors
Hallen, Foyers und Flure
- Wellness and indoor leisure facilities
Wellness- und Indoor-Freizeitanlagen

Mounting/installation on/in wood Strips and plates, plasterboard, tiles, stone, granite, marble and metal surfaces
Montage/Einbau auf/in Holzleisten und -platten, Gipsplatten, Fliesen, Stein-, Granit-, Marmor- und Metalloberflächen



PO13

SURFACE | AUFBAU

bendable | biegebar | LED Strips max. 15 mm

Silver/Silber
ANODIZED | ELOXIERT



max. 15 mm

max.
15 mm

OEM



The PO13 LED SURFACE Profile is made from high-quality aluminium (anodised) and comes in a standard length of 200cm. It is designed for LED flex strips up to a maximum of 15mm in width and can be bent without affecting its function or compactness (see drawing).

Important: the LED flex strip should be fixed after bending! This ensures no kinks, bulges or other damage to the LED strip.

The profile cover (opal/satinised - 65 % transparency) is made from shatterproof, flame-retardant polycarbonate (classification flammability UL94 V-2) and clicks onto the outside of the profile to cover the aluminium area. As a result, you are left with a uniform line of light that subtly blends into the interior design and creates excellent light.

The profile cover also comes in a length of 6m.

Due to its lightweight design, this profile system can be fixed using double-sided tape (see accessories).

Das PO13 LED AUFBAU-Profil ist aus hochwertigem Aluminium (eloxiert) gefertigt und wird standardmäßig mit 200 cm Länge geliefert. Es ist für LED Flexbänder bis zu einer max. Breite von 15 mm konzipiert und lässt sich biegen (siehe Skizze), ohne dass es dabei an Funktionalität und Kompaktheit verliert.

Wichtig: das LED Strip wird erst nach den Biegearbeiten im Profil eingeklebt! So werden Knicken, Wölbungen oder Defekte am LED Strip vermieden.

Die Profilabdeckung (opal/satiniert - Lichtdurchlässigkeit 65 %) besteht aus bruchsicherem und schwer brennbarem Polycarbonat (Klassifizierung Brennbarkeit UL94 V-2) und wird an den Außenseiten des Profils eingeklickt und verdeckt somit den Aluminiumbereich. Als Resultat bleibt eine durchgängig homogene Lichtleiste, die sich in das Raumdesign einfügt und ausgezeichnete Lichtverhältnisse schafft.

Die Profilabdeckung kann auch in einer Länge von 6 m geliefert werden.

Aufgrund des geringen Gewichtes kann dieses Profilsystem mit einem doppelseitigen Klebeband angebracht werden (siehe Zubehör).

GALAXY profiles
Perfect Light Lines

**NARROW, LIGHTWEIGHT AND BENDABLE!
SCHMAL, LEICHT UND BIEGBAR!**

PO13 + C22

BENDING RADIUS
BIEGERADIUS
> 40 CM

- max. 15 mm
- OEM
- Water drop icon

GALAXY profiles
Perfect Light Lines



COVERS | ABDECKUNGEN

C22 65 % 200cm 8600054 600cm 8600055

END CAPS | ENDKAPPEN

E60 E60 8101035

E61 E61 8101036

PROFILE

PO13 200 cm 8101030

Z19 8101037

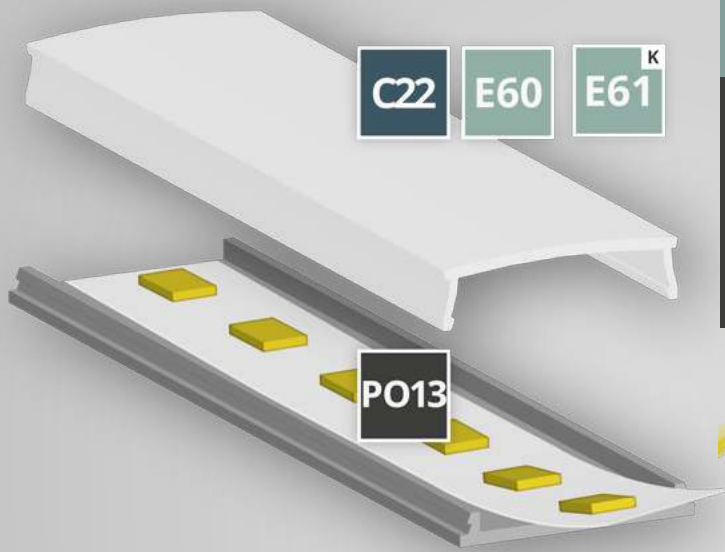

**BENDABLE
BIEGBAR**



**BENDING RADIUS
BIEGERADIUS
> 40 CM**

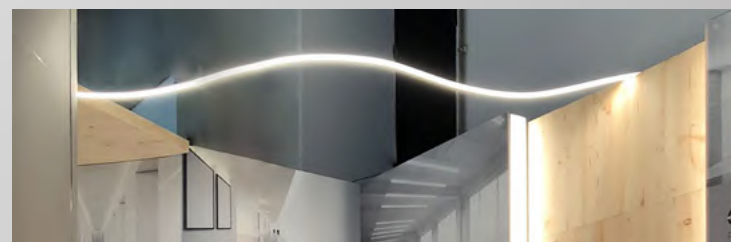

PO13 SURFACE | AUFBAU

bendable | biegebar | LED Strips max. 15 mm
18,0 mm x 2,4 mm | 44 g/m
Bending radius: see drawing | Biegeradius: siehe Skizze

200 cm
8101030



Z19
Mounting Clips
Montageklammer
Sheet steel | Stahlblech
8101037

max.
15 mm

OEM



COVERS | ABDECKUNGEN

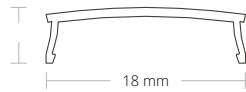

C22 opal | opal | 65 %
PC | 18,0 mm x 4,4 mm
200cm 600cm
8600054 8600055

END CAPS | ENDKAPPEN



E60 Silicone /Silikon | 1 PCS/STK
E60
8101035



E61 Silicone /Silikon | 1 PCS/STK
Cable/Kabel
E61
8101036

PO14

SURFACE | AUFBAU

200 cm

max. 12 mm

OEM



EXTENSION OF SERVICE LIFE
VERLÄNGERUNG LEBENSDAUER

MECHANICAL PROTECTION
MECHANISCHER SCHUTZ

COOLING
KÜHLUNG

HIGH LIGHT UTILISATION
HOHE LICHTVERWERTUNG

HOMOGENEOUS LIGHT
HOMOGENES LICHT

HOMOGENEOUS LIGHT with modular LED light solutions

- Wall, ceiling or floor mounting
Wand-, Decken- oder Bodenmontage
- Residential and office furniture
Wohn- und Büromöbel
- Furniture for business equipment
Möbel für Geschäftsausstattung
- Mirrors | Spiegel
- Cabinet doors | Schranktüren
- Display cases | Vitrinen
- Shelves | Regale
- Stairs and railings
Treppenstufen und -Geländer
- Balustrades | Balustraden
- Living spaces | Wohnräume
- Offices | Büroräume
- Hotel and gastronomy business
Hotellerie und Gastronomie
- Retail (shop and showcase windows)
- Einzelhandel (Shop- und Schaufenster)
- Business areas and showrooms
Geschäftsflächen und Showrooms
- Barber / Beauty / body art studios
Friseur-/Beauty-/Body-Art-Studios
- Halls, foyers and corridors
Hallen, Foyers und Flure

Mounting/installation on/in wood Strips and plates, plasterboard, tiles, stone, granite, marble and metal surfaces
Montage/Einbau auf/in Holzleisten und -platten, Gipsplatten, Fliesen, Stein-, Granit-, Marmor- und Metalloberflächen



PO14

SURFACE | AUFBAU

flat | flach | LED Strips max. 12 mm

Silver/Silber
ANODIZED | ELOXIERT



max. 12 mm



The PO14 LED profile cover (opal/satinised - 65 % transparency) is made from shatterproof, flame-retardant polycarbonate (classification flammability UL94 V-2) and has been designed for the PN33 aluminium cooling strip. Clicked together, the two form an especially thin profile system that can house flex strips up to a maximum width of 12mm.

The cover is clicked to the outside of the cooling strip, covering the aluminium area. Due to its lightweight design, this profile system can be fixed using double-sided tape (see accessories).

The result is a uniform line of light that creates excellent light with a high transfer of the light output.

Note: when applying the LED flex strip to the cooling strip, make sure that the wide side of the cooling strip is stuck to the strips!

Die LED Profilabdeckung PO14 (opal/satiniert - Lichtdurchlässigkeit 65 %) besteht aus bruchsicherem und schwer brennbarem Polycarbonat (Klassifizierung Brennbarkeit UL94 V-2) und wurde eigens für den ALU-KühlStrips PN33 konzipiert. Zusammengeclickt ergeben beide ein besonders schmales Profilsystem, das mit Flexbändern mit einer max. Breite von 12 mm bestückt werden können.

Die Abdeckung wird auf der Außenseite des Kühlstreifens eingeklickt und verdeckt somit den Aluminiumbereich. Aufgrund des geringen Gewichtes kann dieses Profilsystem mit einem doppelseitigen Klebeband angebracht werden (siehe Zubehör).

Als Resultat bleibt eine durchgängig homogene Lichtleiste, die ausgezeichnete Lichtverhältnisse mit einer hohen Verwertung der Lichtleistung schafft.

Hinweis: beim Anbringen des LED Strips am KühlStrips darauf achten, dass die breitere Seite des Kühlstreifens mit den Strips beklebt wird!

GALAXY profiles
Perfect Light Lines

BENDABLE | BIEGBAR

PN33 + PO14

- max. 12 mm
- OEM
- Water drop icon

GALAXY profiles
Perfect Light Lines

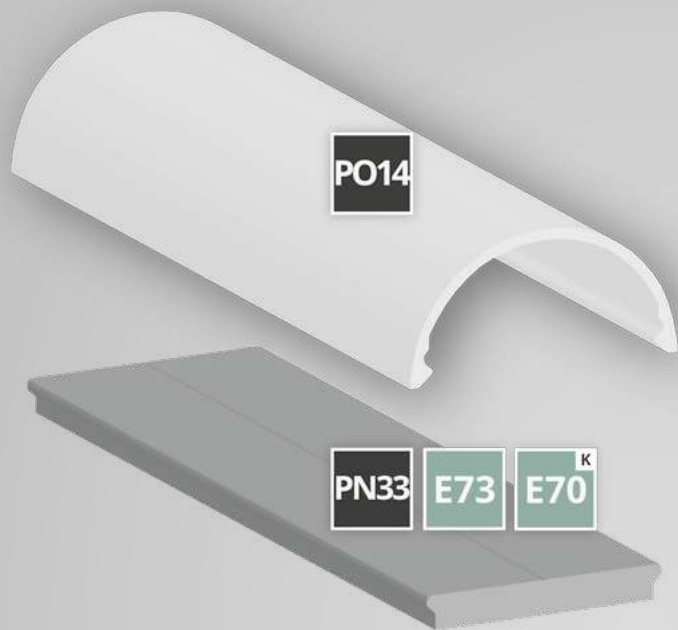

COVERS | ABDECKUNGEN

PO14 65% 200cm
8600045

END CAPS | ENDKAPPEN

E73 E73
8101045

E70 E70
8101046

PROFILE

PN33 200 cm
8105050



**BENDABLE
BIEGBAR**

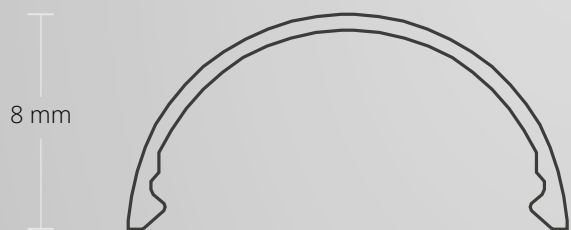

PO14

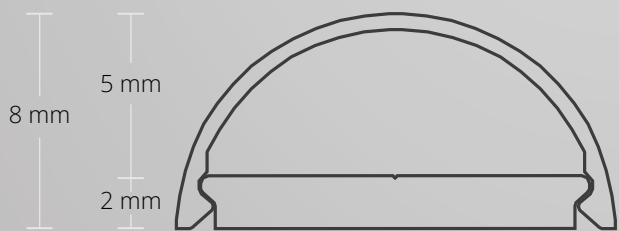

PO14 + PN33



PO14 SURFACE | AUFBAU

LED Strips max. 12 mm

PC | opal | opal | 65 % | 16,3 mm x 8 mm

200 cm
8600045

max.
12 mm



OEM



PROFILE



PN33 Aluminium anodized | Aluminium eloxiert

14,6 mm x 2 mm | 77 g/m

200cm
8105050

END CAPS | ENDKAPPEN



E73 Silicone /Silikon | 1 PCS/STK

E73
8101045



E70 Silicone /Silikon | 1 PCS/STK

Cable/Kabel
E70
8101046

P015

SURFACE | AUFBAU

200 cm | 300 cm

max. 12 mm

OEM

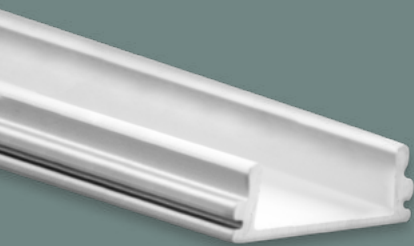
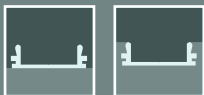

EXTENSION OF SERVICE LIFE
VERLÄNGERUNG LEBENSDAUER

MECHANICAL PROTECTION
MECHANISCHER SCHUTZ

COOLING
KÜHLUNG

HIGH LIGHT UTILISATION
HOHE LICHTVERWERTUNG

HOMOGENEOUS LIGHT
HOMOGENES LICHT

HOMOGENEOUS LIGHT with modular LED light solutions

- Wall, ceiling or floor mounting
Wand-, Decken- oder Bodenmontage
- Residential and office furniture
Wohn- und Büromöbel
- Furniture for business equipment
Möbel für Geschäftsausstattung
- Home accessories
Wohnaccessoires
- Mirrors | Spiegel
- Cabinet doors | Schranktüren
- Display cases | Vitrinen
- Shelves | Regale
- Stairs and railings
Treppenstufen und -Geländer
- Balustrades | Balustraden
- Façades, balconies and terraces
Fassaden, Balkone und Terrassen
- Living spaces | Wohnräume
- Offices | Büroräume
- Hotel and gastronomy business
Hotellerie und Gastronomie
- Retail (shop and showcase windows)
Einzelhandel (Shop- und Schaufenster)
- Business areas and showrooms
Geschäftsflächen und Showrooms
- Barber / Beauty / body art studios
Friseur-/Beauty-/Body-Art-Studios
- Halls, foyers and corridors
Hallen, Foyers und Flure
- Wellness and indoor leisure facilities
Wellness- und Indoor-Freizeitanlagen
- Wet rooms | Nasszellen

Mounting/installation on/in wood Strips and plates, plasterboard, tiles, stone, granite, marble and metal surfaces
Montage/Einbau auf/in Holzleisten und -platten, Gipsplatten, Fliesen, Stein-, Granit-, Marmor- und Metalloberflächen



PO15

SURFACE | AUFBAU

ultra-flat | ultraflach | LED Strips max. 12 mm

Silver/Silber
ANODIZED | ELOXIERT



max. 12 mm

max. 12 mm

OEM

PO15 LED SURFACE Profile has a particularly narrow and extremely flat design, it is designed for LED flexstrips with a maximum width of 12 mm and is universally used in interior areas. Use the profile for application-specific installations as a recess profile.

The LED profile covers opal/satinised (translucency 65 %) are made of shatter-proof, non-flammable polycarbonate (classification flammability UL94 V-2) and create homogeneous LED lighting conditions with high utilisation of the light output.

Covers also available in 6m length!

This LED SURFACE Profile can be fitted with three different plastic covers - flat, high or round cover. All three covers enclose the SURFACE profile on the open side. Thus only the LED light bar is visible. With the high and round covers, the light from the LED strips is illuminated in three directions (also to the side). The interior height (distance between LED chips and cover) is coordinated for a continuous light line - no pinpoint of light!

The PO15 LED SURFACE Profile is extremely flat and thus fits very well into the environment. This is ideally suited as a LED light source in residential and office furniture, home accessories, display cases, shelves and stairs and on walls and ceilings, among other things, due to their small dimensions and low weight.

Das PO15 LED AUFBAU-Profil hat ein besonders schmales und ultraflaches Design, ist für LED Flexbänder mit einer maximalen Breite von 12 mm konzipiert und wird universell im Innenbereich eingesetzt. Dieses Alu-Profil kann auch anwendungsspezifisch zum Einbau verwendet werden.

Die LED Profilabdeckungen Opal/satiniert (Lichtdurchlässigkeit 65 %) bestehen aus bruchsicherem und schwer brennbarem Polycarbonat (Klassifizierung Brennbarkeit UL94 V-2) und schaffen homogene LED Lichtverhältnisse mit hoher Verwertung der Lichtleistung.

Abdeckungen auch in 6 m verfügbar!

Dieses LED AUFBAU-Profil kann mit drei unterschiedlichen Kunststoffabdeckungen bestückt werden – flache, hohe oder runde Abdeckung. Alle drei Abdeckungen umschließen das AUFBAU-Profil an der offenen Seite. Somit ist nur noch die LED Lichtleiste sichtbar. Bei der hohen und runden Abdeckungen leuchtet das Licht der LED Strips in drei Richtungen (auch seitlich). Die Innenhöhe (Abstand zwischen LED Chips und Abdeckung) ist für eine durchgängige Lichtlinie abgestimmt - keine Lichtpunkte!

Das PO15 LED AUFBAU-Profil ist ultraflach und fügt sich somit sehr gut in die Umgebungsbedingungen ein. Wegen der kleinen Abmessungen und des geringen Gewichtes ist es unter anderem als ideale LED Lichtquelle in Wohn- und Büromöbeln, Wohnaccessoires, Vitrinen, Regalen sowie an Treppenstufen, Wänden und Decken geeignet.

GALAXY profiles
Perfect Light Lines

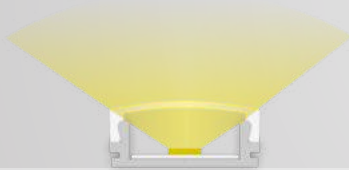

PO15 + C3



PO15+ C5

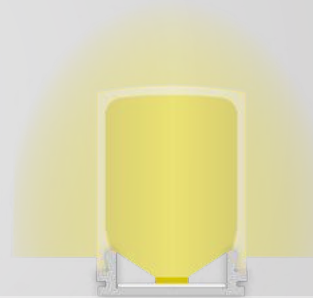

PO15 + C4

- max. 12 mm
- OEM
- Water drop icon

GALAXY profiles
Perfect Light Lines

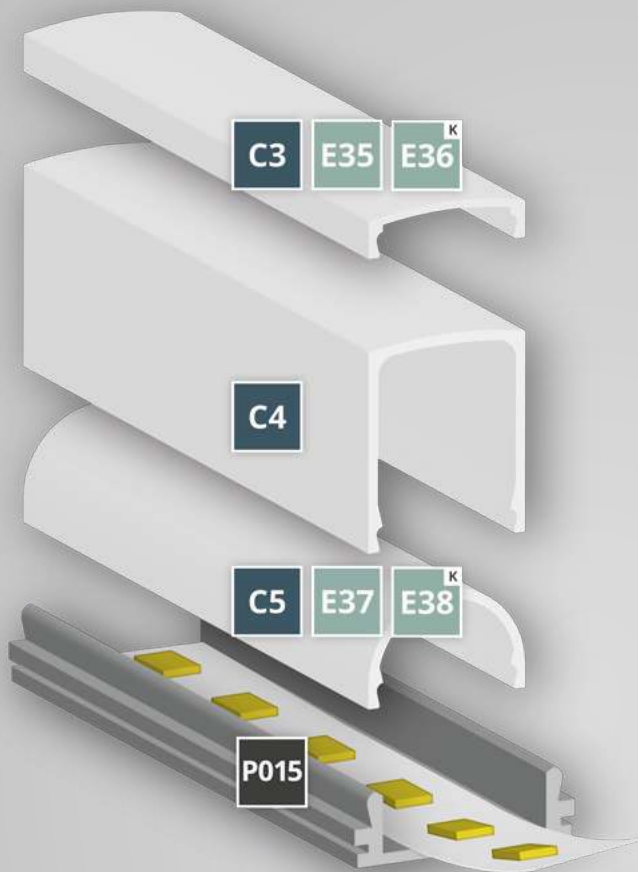
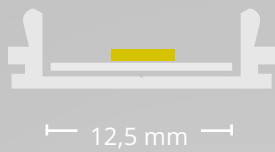

COVERS | ABDECKUNGEN

C3 65 %	200cm 8600005	300 cm 8600027	600 cm 8600038
C4 65 %	200 cm 8600006		
C5 65 %	200 cm 8600007		

END CAPS | ENDKAPPEN

E35	E35 8102060	E35 8102061
E36	E36 8103062	E36 8103063
E37	E37 8102070	
E38	E38 8102072	

PROFILE

P015	200 cm 8102062	300 cm 8102162
	Z01 8106210	

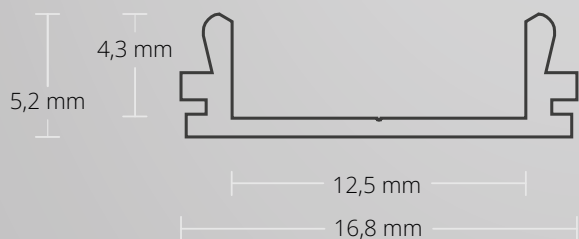

PO15 SURFACE | AUFBAU

ultra-flat | ultraflach | LED Strips max. 12 mm
16,8 mm x 5,2 mm | 65 g/m

200 cm **8102062** 300 cm **8102162**



Z01
Mounting Clips
Montageklammer



8106210
8106212
8106211

max.
12 mm



OEM



COVERS | ABDECKUNGEN

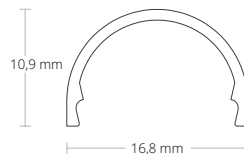
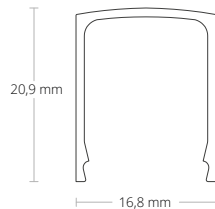
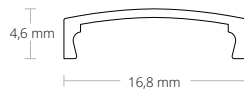

C3 opal | opal | 65 %
PC | 16,8 mm x 4,6 mm
200cm **8600005** 300cm **8600027** 600cm **8600038**

C4 opal | opal | 65 %
PC | 16,8 mm x 20,9 mm
200cm **8600006**

C5 opal | opal | 65 %
PC | 16,8 mm x 10,9 mm
200cm **8600007**

END CAPS | ENDKAPPEN



E35 **C3** PVC | 1 PCS/STK
E35 **8102060** E35 **8102061**



E36 **C3** PVC | 1 PCS/STK | Cable/Kabel
E36 **8103062** E36 **8103063**



E37 **C5** PVC | 1 PCS/STK
E37 **8102070**



E38 **C5** PVC | 1 PCS/STK | Cable/Kabel
E38 **8102072**

PO16

SURFACE | AUFBAU

200 cm | 300 cm

max. 8 mm

OEM



EXTENSION OF SERVICE LIFE
VERLÄNGERUNG LEBENSDAUER

MECHANICAL PROTECTION
MECHANISCHER SCHUTZ

COOLING
KÜHLUNG

HIGH LIGHT UTILISATION
HOHE LICHTVERWERTUNG

HOMOGENEOUS LIGHT
HOMOGENES LICHT

HOMOGENEOUS LIGHT with modular LED light solutions

- Home and office furniture
Wohn- und Büromöbel
- Office equipment
Möbel für Büroausstattung
- Mirrors | Spiegel
- Cupboard doors | Schranktüren
- Display cabinets | Vitrinen
- Shelving | Regale
- Stairs and handrails
Treppenstufen und Geländer
- Balustrades | Balustraden
- Homes | Wohnräume
- Common rooms | Aufenthaltsräume
- Offices, conference and presentation rooms
Büro-, Konferenz- und Präsentationsräume
- Waiting rooms | Ordinationen
- Business premises and sales floors
Geschäfts- und Verkaufsflächen
- Showrooms
- Hotel and gastronomy
Hotellerie und Gastronomie
- Foyers, corridors and connecting rooms
Foyers, Flure und Verbindungsräume
- Waiting and common rooms
Warte- und Aufenthaltsräume
- Commercial premises (e.g. hair salons)
Gewerbliche Dienstleistungsräumlichkeiten
(z. B. Friseursalons etc.)

Mounting/installation on/in wood Strips and plates, plasterboard, tiles, stone, granite, marble and metal surfaces
Montage/Einbau auf/in Holzleisten und -platten, Gipsplatten, Fliesen, Stein-, Granit-, Marmor- und Metalloberflächen



PO16

SURFACE | AUFBAU

LED Strips max. 8 mm

Silver/Silber
ANODIZED | ELOXIERT

RAL 9005 Black/Schwarz
POWDER-COATED | PULVERBESCHICHTET



max. 8 mm

max.
8 mm



OEM



SLIM | FLAT | IDEAL FOR FURNITURE - 10 x 9.2 MM

The PO16 LED RECESSED/SURFACE Profile is 200cm long as standard and is made from high-quality aluminium (anodised). It is slim and flat in design and especially designed for integrating into furniture. The PO16 can also be mounted on ceilings and walls as an integrated or surface-mounted profile (mounting clips available).

The LED profile covers opal/satinised (translucency 65 %), or black matt (translucency 25 %) made from shatterproof, flame-retardant polycarbonate (classification flammability UL94 V-2 - opal/satinised - 65 % transparency), the top of the aluminium profile is completely covered. LED flex strips with a maximum width of 8mm can be fixed with adhesive.

Covers also available in 6m length!

The cover obscures the aluminium on the profile - so only the line of light is visible! The result is unified light and a high transfer of the light output!

SCHMAL | FLACH | IDEAL FÜR MÖBELBAU - 10 x 9,2 MM

Das PO16 LED EIN-/AUFBAU-Profil wird standardmäßig in der Länge von 200 cm geliefert und ist aus hochwertigem Aluminium (eloxiert) gefertigt. Es ist schmal und flach designt und besonders für die Integration in Möbel konzipiert. Das PO16 kann aber auch selbstverständlich an Decken und Wänden als Einbau- oder Aufbauprofil angebracht werden (Montageklammern verfügbar).

Die LED Profilabdeckungen Opal/satiniert (Lichtdurchlässigkeit 65 %) oder Schwarz Matt (Lichtdurchlässigkeit 25 %) aus bruchsicherem und schwer brennbaren Polycarbonat (Klassifizierung Brennbarkeit UL94 V-2) wird das ALU-Profil oberseitig komplett abgedeckt. Es können LED Flexbänder mit einer max. Breite von 8 mm eingeklebt werden.

Abdeckungen auch in 6 m verfügbar!

Die Abdeckung überdeckt das Alu der Profile – man sieht nur noch die Lichtlinie! Homogene Lichtverhältnisse und hohe Verwertung der Lichtleistung sind das Ergebnis!

GALAXY profiles
Perfect Light Lines



PO16+ C23



PO16+ C23

1:1

ORIGINAL SIZE | ORIGINALGRÖSSE



- max. 8 mm
- OEM
- Water drop icon

GALAXY profiles
Perfect Light Lines

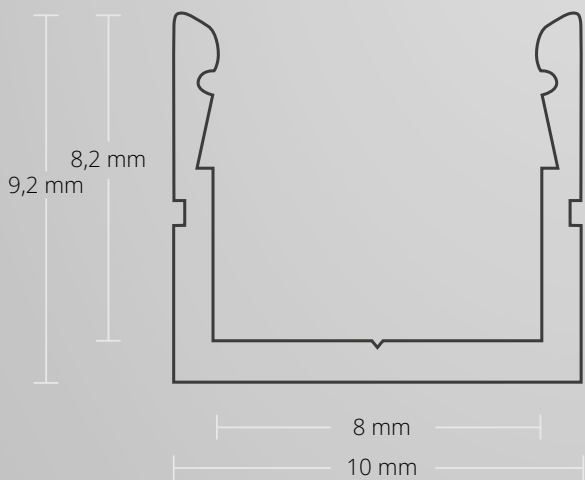
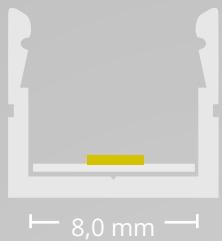

COVERS | ABDECKUNGEN

C23 65 % 200cm 8600046 300 cm 8600116 600 cm 8600047

C34 25 % 200 cm 8600074 600 cm 8600075

END CAPS | ENDKAPPEN

E62 E62 8101055 **E122** E122 8123589

E63 E63 8101056 **E123** E123 8123590

PROFILE

PO16 200 cm 8101050 300 cm 8101054 200 cm 8101051

Z20 8101057

1:1

ORIGINAL SIZE | ORIGINALGRÖSSE



PO16 SURFACE | AUFBAU

LED Strips max. 8 mm
10,0 mm x 9,2 mm | 60 g/m

200 cm 300 cm 200 cm
8101050 8101054 8101051



Z20
Mounting Clips
Montageklammer
Sheet steel | Stahlblech
8101057



max.
8 mm



OEM



COVERS | ABDECKUNGEN

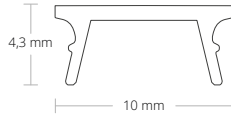
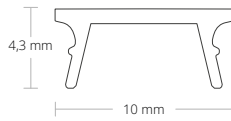

C23 opal | opal | 65 %

PC | 10,0 mm x 4,3 mm

200cm 300cm 600cm
8600046 8600116 8600047

C34 black/matt | schwarz/matt | 25 %

PC | 10,0 mm x 4,3 mm

200cm 600cm
8600074 8600075

END CAPS | ENDKAPPEN



E62 Silicone /Silikon | 1 PCS/STK

E62 E122
8101055 8123589

NEW



E63 Silicone /Silikon | 1 PCS/STK

Cable/Kabel

E63 E123
8101056 8123590

NEW

PO17

SURFACE | AUFBAU

200 cm | 300 cm

max. 11 mm

OEM



EXTENSION OF SERVICE LIFE
VERLÄNGERUNG LEBENSDAUER

MECHANICAL PROTECTION
MECHANISCHER SCHUTZ

COOLING
KÜHLUNG

HIGH LIGHT UTILISATION
HOHE LICHTVERWERTUNG

HOMOGENEOUS LIGHT
HOMOGENES LICHT

HOMOGENEOUS LIGHT with modular LED light solutions

- Wall, ceiling or floor mounting
Wand-, Decken- oder Bodenmontage
- Stairs
Treppenstufen
- Façades, balconies and terraces
Fassaden, Balkone und Terrassen
- Living spaces | Wohnräume
- Offices | Büroräume
- Hotel and gastronomy business
Hotellerie und Gastronomie
- Retail (shop and showcase windows)
Einzelhandel (Shop- und Schaufenster)
- Business areas and showrooms
Geschäftsflächen und Showrooms
- Barber / Beauty / body art studios
Friseur-/Beauty-/Body-Art-Studios
- Halls, foyers and corridors
Hallen, Foyers und Flure
- Wellness and indoor leisure facilities
Wellness- und Indoor-Freizeitanlagen
- Wet rooms | Nasszellen

Mounting/installation on/in wood Strips and plates, plasterboard, tiles, stone, granite, marble and metal surfaces
Montage/Einbau auf/in Holzleisten und -platten, Gipsplatten, Fliesen, Stein-, Granit-, Marmor- und Metalloberflächen



PO17

SURFACE | AUFBAU

ultra-flat/wings | ultraflach/Flügel

Silver/Silber
ANODIZED | ELOXIERT



max. 11 mm

max.
11 mm



OEM



PO17 LED SURFACE Profile has a particularly narrow and extremely flat design, is designed for LED flexstrips with a maximum width of 11 mm and is universally used in interior areas.

The LED profile covers opal/satinised (translucency 65 %) and clear (translucency 85 %) are made of shatter-proof, non-flammable polycarbonate (classification flammability UL94 V-2) and create homogeneous LED lighting conditions with high utilisation of the light output.

The PO17 LED SURFACE Profile is extremely flat and thus fits very well into the environment. It is ideally suited as a LED light source in residential and office rooms, retail shops as well as hotel and gastronomy businesses, among other things, due to their small dimensions and low weight.

Das PO17 LED AUFBAU-Profil hat ein besonders schmales und ultraflaches Design, es ist für LED Flexbänder mit einer maximalen Breite von 11 mm konzipiert und wird universell im Innenbereich eingesetzt.

Die LED Profilabdeckungen Opal/satiniert (Lichtdurchlässigkeit 65 %) und Klar (Lichtdurchlässigkeit 85 %) bestehen aus bruchsicherem und schwer brennbarem Polycarbonat (Klassifizierung Brennbarkeit UL94 V-2) und schaffen homogene LED Lichtverhältnisse mit hoher Verwertung der Lichtleistung.

Das PO17 LED AUFBAU-Profil ist ultraflach und fügt sich somit sehr gut in die Umgebungsbedingungen ein. Wegen der kleinen Abmessungen und des geringen Gewichtes ist es unter anderem als ideale LED Lichtquelle in Wohn- und Büroräumen, im Einzelhandel sowie in der Hotellerie/Gastronomie geeignet.

GALAXY profiles
Perfect Light Lines

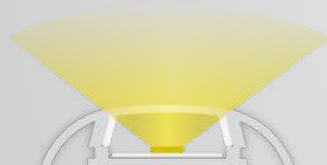

PO17 + C8



PO17 + C9

max.
11 mm

OEM

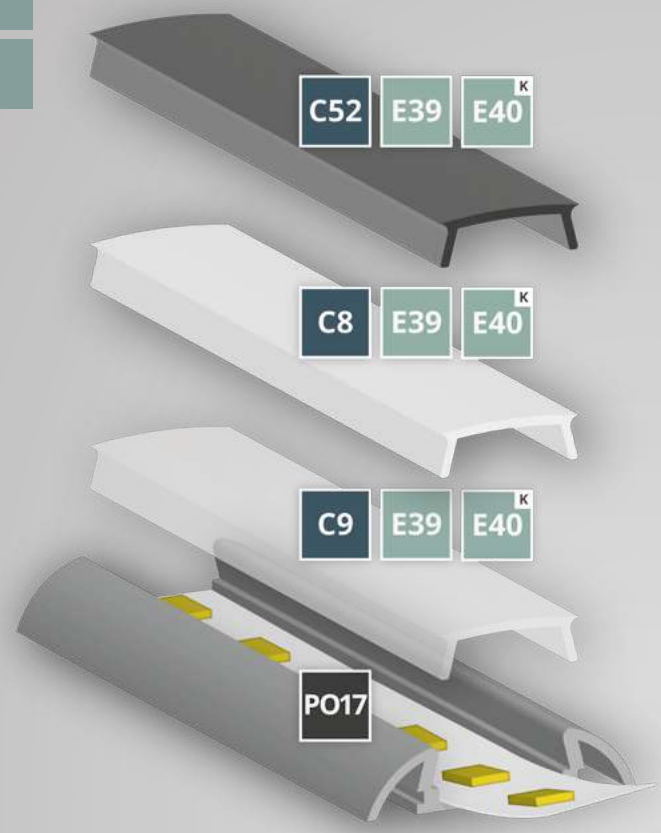
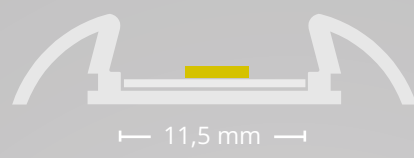

COVERS | ABDECKUNGEN

C8 65 %	200cm 8600013	300 cm 8600028	600 cm 8600056
C9 85 %	200 cm 8600012		
C52 25 %	200 cm 8600109	600 cm 8600110	

END CAPS | ENDKAPPEN

E39	E39 8102080
E40	E40 8102082

PROFILE

PO17	200 cm 8103082	300 cm 8103182
-------------	-------------------	-------------------

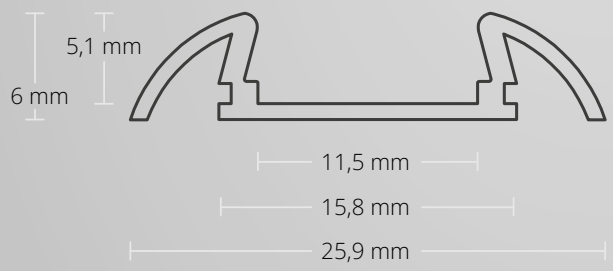

PO17 SURFACE | AUFBAU

ultra-flat/wings | ultraflach/Flügel | LED Strips max. 11 mm
25,9 mm x 6,0 mm | 117 g/m

200 cm
8103082

300 cm
8103182

max.
11 mm



OEM



COVERS | ABDECKUNGEN

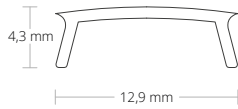

C8 opal | opal | 65 %

PC | 12,9 mm x 4,3 mm

200cm

8600013

300cm

8600028

600cm

8600056

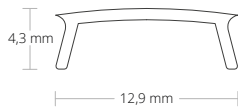

C9 clear | klar | 85 %

PC | 12,9 mm x 4,3 mm

200cm

8600012

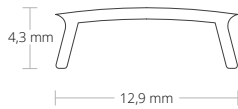

C52 black/matt | schwarz/matt | 25 %

PC | 12,9 mm x 4,3 mm

200cm

8600109

600cm

8600110

END CAPS | ENDKAPPEN



E39 PVC | 1 PCS/STK

E39
8102080



E40 PVC | 1 PCS/STK | Cable/Kabel

E40
8102082

PO18

SURFACE | AUFBAU

200 cm

max. 6 mm

OEM

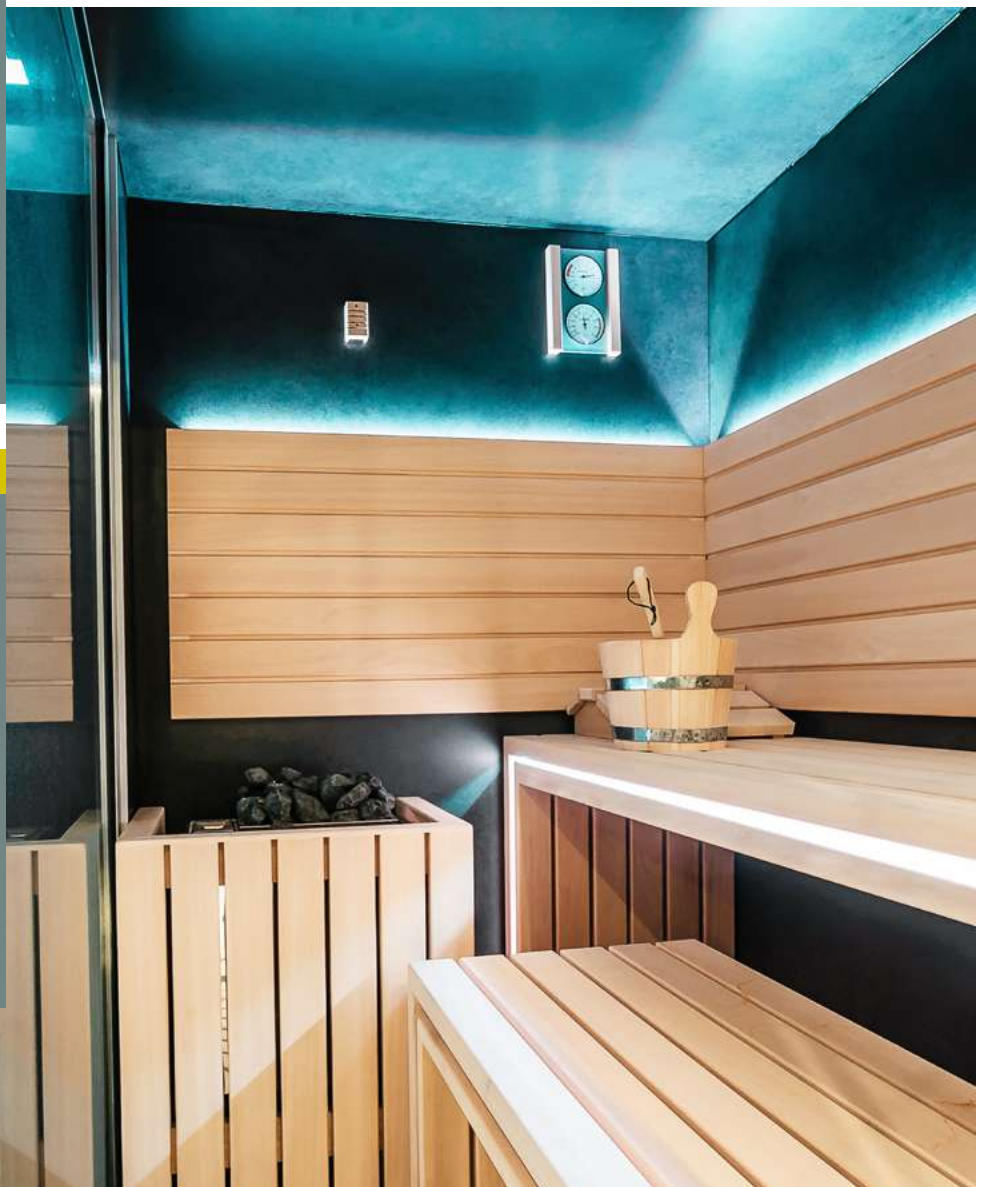

EXTENSION OF SERVICE LIFE
VERLÄNGERUNG LEBENSDAUER

MECHANICAL PROTECTION
MECHANISCHER SCHUTZ

COOLING
KÜHLUNG

HIGH LIGHT UTILISATION
HOHE LICHTVERWERTUNG

HOMOGENEOUS LIGHT
HOMOGENES LICHT

HOMOGENEOUS LIGHT with modular LED light solutions

- Spa and wellness areas
SPA- und Wellnessbereiche
- Swimming pools
Schwimm-/Hallenbäder
- Bathrooms/WCs
Bad/WC
- Kitchens
Küche
- Utility rooms/cellars
Waschküche/Keller
- Car washes
Autowaschanlagen/-waschstraßen
- Basically in any tile concept
Grundsätzlich in jedes Fliesenkonzept
- Access paths, paths in parks and green areas
Park-, Grünanlagen und Zufahrten
- Outdoor areas
Outdoorbereiche
- Building facades
Gebäudefassaden

Mounting/installation on/in wood Strips and plates, plasterboard, tiles, stone, granite, marble and metal surfaces

Montage/Einbau auf/in Holzleisten und -platten, Gipsplatten, Fliesen, Stein-, Granit-, Marmor- und Metalloberflächen



INSTALLATION INSTRUCTION INSTALLATIONS MONTAGE





PO18

SURFACE | AUFBAU

LED Strips max. 6 mm

Silver/Silber
ANODIZED | ELOXIERT

RAL 9005 Black/Schwarz
POWDER-COATED | PULVERBESCHICHTET



max. 6 mm

max.
6 mm



OEM



SLIM | FLAT | IDEAL FOR TILE CONCEPTS – 7,8 x 7 MM

The PO18 LED RECESSED/SURFACE Profile is 200cm long as standard and is made from high-quality aluminium (anodised). It is especially slim and flat, and is designed for use in tile concepts (just 7.8 x 7 mm).

The LED profile covers opal/satinised (translucency 65 %) are made of shatter-proof, non-flammable polycarbonate (classification flammability UL94 V-2) and create homogeneous LED lighting conditions with high utilisation of the light output.

The PO18 LED SURFACE Profile is extremely flat and thus fits very well into the environment. It is ideally suited as a LED light source in residential and office rooms, retail shops as well as hotel and gastronomy businesses, among other things, due to their small dimensions and low weight.

Covers also available in 6m length!

The cover obscures the aluminium on the profile - so only the line of light is visible! The result is unified light and a high transfer of the light output!

SCHMAL | FLACH | IDEAL FÜR FLIESENKONZEPTE – 7,8 x 7 MM

Das PO18 LED EIN-/AUFBAU-Profil wird standardmäßig in der Länge von 200 cm geliefert und ist aus hochwertigem Aluminium (eloxiert) gefertigt. Es ist besonders schmal, flach design und für den Einsatz in Fliesenkonzepten vorgesehen (nur 7,8 x 7 mm).

Die LED Profilabdeckungen Opal/satiniert (Lichtdurchlässigkeit 65 %) besteht aus bruchsicherem und schwer brennbarem Polycarbonat (Klassifizierung Brennbarkeit UL94 V-2) und schaffen homogene LED Lichtverhältnisse mit hoher Verwertung der Lichtleistung.

Das PO18 LED AUFBAU-Profil ist ultraflach und fügt sich somit sehr gut in die Umgebungsbedingungen ein. Wegen der kleinen Abmessungen und des geringen Gewichtes ist es unter anderem als ideale LED Lichtquelle in Wohn- und Büroräumen, im Einzelhandel sowie in der Hotellerie/Gastronomie geeignet.

Abdeckungen auch in 6 m verfügbar!

Die Abdeckung überdeckt das Alu der Profile – man sieht nur noch die Lichtlinie! Homogene Lichtverhältnisse und hohe Verwertung der Lichtleistung sind das Ergebnis!

GALAXY profiles
Perfect Light Lines

Homogeneous light in a compact package
Homogenes Licht trotz kleinster Abmessungen



PO18 + C24

1:1

ORIGINAL SIZE | ORIGINALGRÖSSE



- max. 6 mm
- OEM
- Water drop icon

GALAXY profiles
Perfect Light Lines

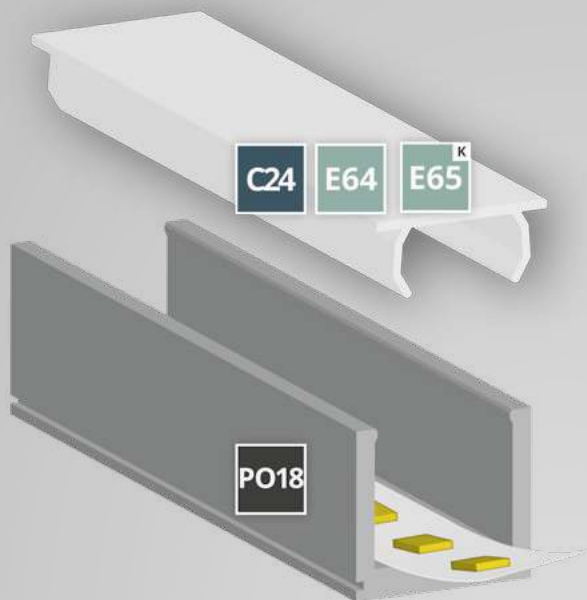
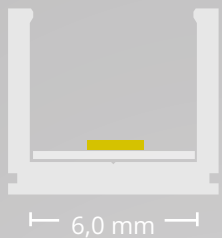

COVERS | ABDECKUNGEN

C24 65 % 200cm 8600106 600 cm 8600107

END CAPS | ENDKAPPEN

E64 E64 8101065

E65 E65 8101066

PROFILE

PO18 200 cm 8101060 200 cm 8101062

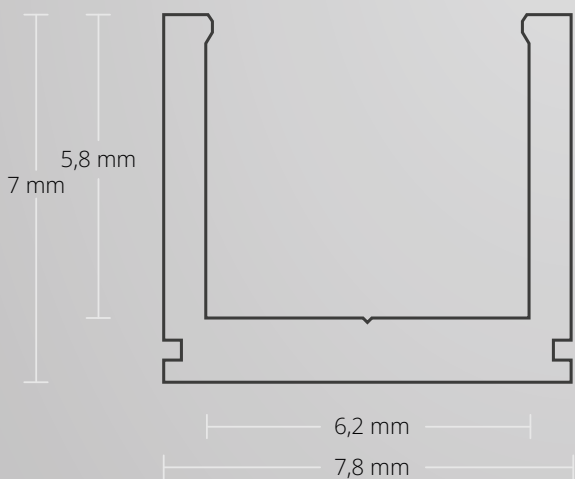

1:1
ORIGINAL SIZE | ORIGINALGRÖSSE





PO18 SURFACE | AUFBAU

LED Strips max. 6 mm

7,8 mm x 7,0 mm | 45 g/m

200 cm
8101060

200 cm
8101062

max.
6 mm



OEM



COVERS | ABDECKUNGEN

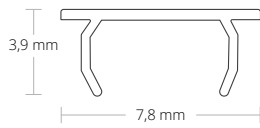

C24 opal | opal | 65 %

PC | 7,8 mm x 3,9 mm

200cm

8600106

600cm

8600107

END CAPS | ENDKAPPEN



E64 C24 Silicone /Silikon | 1 PCS/STK

E64
8101065



E65 C24 Silicone /Silikon | 1 PCS/STK |
Cable/Kabel

E65
8101066

PO23

CORNER | ECK

200 cm

max. 11 mm

OEM

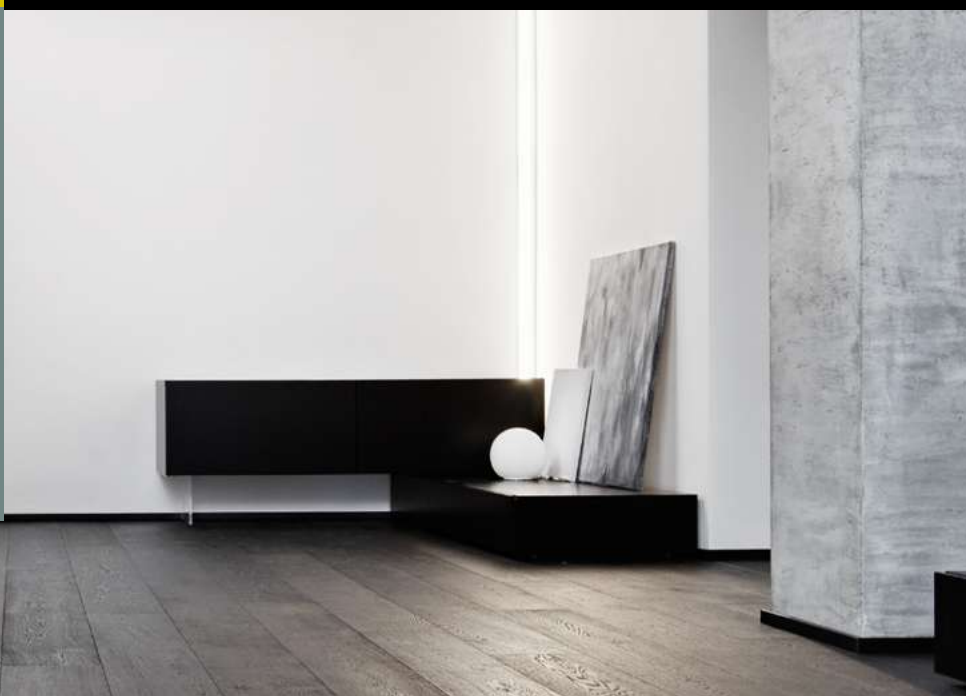
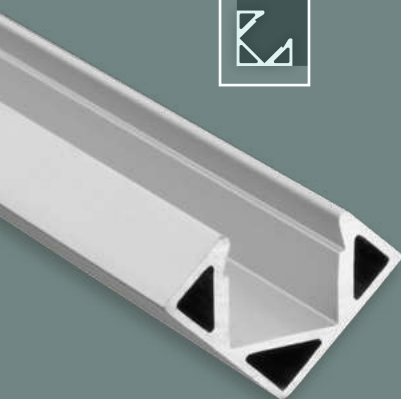

EXTENSION OF SERVICE LIFE
VERLÄNGERUNG LEBENSDAUER

MECHANICAL PROTECTION
MECHANISCHER SCHUTZ

COOLING
KÜHLUNG

HIGH LIGHT UTILISATION
HOHE LICHTVERWERTUNG

HOMOGENEOUS LIGHT
HOMOGENES LICHT

HOMOGENEOUS LIGHT with modular LED light solutions

- Wall, ceiling or floor mounting
Wand-, Decken- oder Bodenmontage
- Residential and office furniture
Wohn- und Büromöbel
- Furniture for business equipment
Möbel für Geschäftsausstattung
- Home accessories
Wohnaccessoires
- Mirrors | Spiegel
- Cabinet doors | Schranktüren
- Display cases | Vitrinen
- Shelves | Regale
- Stairs and railings
Treppenstufen und -Geländer
- Balustrades | Balustraden
- Façades, balconies and terraces
Fassaden, Balkone und Terrassen
- Living spaces | Wohnräume
- Offices | Büroräume
- Hotel and gastronomy business
Hotellerie und Gastronomie
- Retail (shop and showcase windows)
Einzelhandel (Shop- und Schaufenster)
- Business areas and showrooms
Geschäftsflächen und Showrooms
- Barber / Beauty / body art studios
Friseur-/Beauty-/Body-Art-Studios
- Halls, foyers and corridors
Hallen, Foyers und Flure
- Wellness and indoor leisure facilities
Wellness- und Indoor-Freizeitanlagen
- Wet rooms | Nasszellen

Mounting/installation on/in wood Strips and plates, plasterboard, tiles, stone, granite, marble and metal surfaces
Montage/Einbau auf/in Holzleisten und -platten, Gipsplatten, Fliesen, Stein-, Granit-, Marmor- und Metalloberflächen



PO23

CORNER | ECK

LED Strips max. 11 mm

 Silver/Silber
ANODIZED | ELOXIERT

 RAL 9010 White/Weiß
POWDER-COATED | PULVERBESCHICHTET

 RAL 9005 Black/Schwarz
POWDER-COATED | PULVERBESCHICHTET



max. 11 mm

**max.
11 mm**



OEM



PO23 LED CORNER profile is designed for LED flexstrips with a maximum width of 11 mm and is universally used in interior areas.

The LED profile covers opal/satinised (translucency 65 %), clear (translucency 85 %) and black/matt (translucency 25 %) are made of shatter-proof, non-flammable polycarbonate (classification flammability UL94 V-2) and create homogeneous LED lighting conditions with high utilisation of the light output (no pinpoint of light, but rather continuous lines of light).

The PO23 LED CORNER profile is dimensioned extremely small and is ideally suited as a LED light source in residential and office furniture, home accessories, display cases, shelves as well as on stairs, walls and ceilings, among other things, due to its low weight.

Das PO23 LED ECK-Profil ist für LED Flexbänder mit einer maximalen Breite von 11 mm konzipiert und wird universell im Innenbereich eingesetzt.

Die LED Profilabdeckungen Opal/satiniert (Lichtdurchlässigkeit 65 %), Klar (Lichtdurchlässigkeit 85 %) und Schwarz/Matt (Lichtdurchlässigkeit 25 %) bestehen aus bruchsicherem und schwer brennbarem Polycarbonat (Klassifizierung Brennbarkeit UL94 V-2) und schaffen homogene LED Lichtverhältnisse mit hoher Verwertung der Lichtleistung (keine Lichtpunkte, sondern durchgängige Lichtlinie).

Das PO23 LED ECK-Profil ist ultraklein dimensioniert und aufgrund des geringen Gewichtes unter anderem als ideale LED Lichtquelle in Wohn- und Büromöbeln, Wohnaccessoires, Vitrinen, Regalen sowie an Treppenstufen, Wänden und Decken geeignet.

GALAXY profiles
Perfect Light Lines

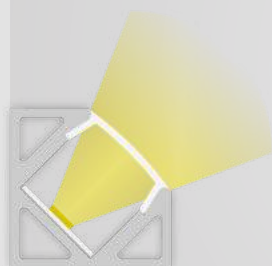

PO23 + C9



PO23 + C52



PO23 + C8

- max. 11 mm
- OEM
-

GALAXY profiles
Perfect Light Lines

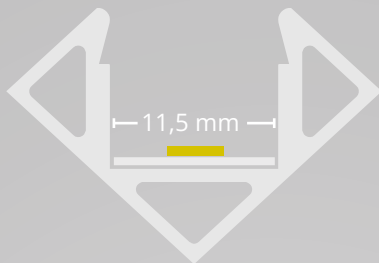

COVERS | ABDECKUNGEN

C8 65 % 200cm 8600013 300 cm 8600028 600 cm 8600056

C9 85 % 200 cm 8600012

C52 25 % 200 cm 8600109 600 cm 8600110

END CAPS | ENDKAPPEN

E41 E41 8103050 E41 8103053 E41 8103055

E42 E42 8103052 E42 8103054 E42 8103056

PROFILE

PO23 200 cm 8104052 200 cm 8104053 200cm 8104054

Z02 8104050

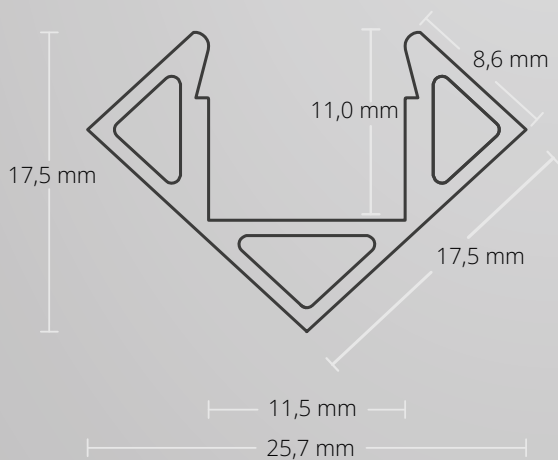

PO23 CORNER | ECK

LED Strips max. 11 mm
25,7 mm x 17,5 mm | 207 g/m

200 cm 200 cm 200 cm
8104052 8104053 8104054



Z02

Mounting Clips
Montageklammer
Sheet steel | Stahlblech
8104050

max.
11 mm



OEM



COVERS | ABDECKUNGEN

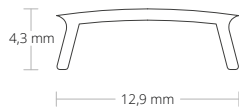

C8 opal | opal | 65 %

PC | 12,9 mm x 4,3 mm

200cm 300cm 600cm
8600013 8600028 8600056

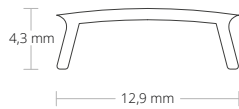

C9 clear | klar | 85 %

PC | 12,9 mm x 4,3 mm

200cm
8600012

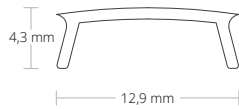

C52 black/matt | schwarz/matt | 25 %

PC | 12,9 mm x 4,3 mm

200cm 600cm
8600109 8600110

END CAPS | ENDKAPPEN



E41 PVC | 1 PCS/STK

E41 E41 E41
8103050 8103053 8103055



E42 PVC | 1 PCS/STK | Cable/Kabel

E42 E42 E42
8103052 8103054 8103056

PO23V2

CORNER | ECK

200 cm | 300 cm

max. 11 mm

OEM

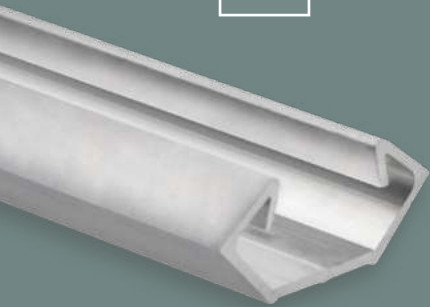

EXTENSION OF SERVICE LIFE
VERLÄNGERUNG LEBENSDAUER

MECHANICAL PROTECTION
MECHANISCHER SCHUTZ

COOLING
KÜHLUNG

HIGH LIGHT UTILISATION
HOHE LICHTVERWERTUNG

HOMOGENEOUS LIGHT
HOMOGENES LICHT

HOMOGENEOUS LIGHT with modular LED light solutions

- Wall, ceiling or floor mounting
Wand-, Decken- oder Bodenmontage
- Residential and office furniture
Wohn- und Büromöbel
- Furniture for business equipment
Möbel für Geschäftsausstattung
- Home accessories
Wohnaccessoires
- Mirrors | Spiegel
- Cabinet doors | Schranktüren
- Display cases | Vitrinen
- Shelves | Regale
- Stairs
Treppenstufen
- Balustrades | Balustraden
- Façades, balconies and terraces
Fassaden, Balkone und Terrassen
- Living spaces | Wohnräume
- Offices | Büroräume
- Hotel and gastronomy business
Hotellerie und Gastronomie
- Retail (shop and showcase windows)
Einzelhandel (Shop- und Schaufenster)
- Business areas and showrooms
Geschäftsflächen und Showrooms
- Barber / Beauty / body art studios
Friseur-/Beauty-/Body-Art-Studios
- Halls, foyers and corridors
Hallen, Foyers und Flure
- Wellness and indoor leisure facilities
Wellness- und Indoor-Freizeitanlagen
- Wet rooms | Nasszellen

Mounting/installation on/in wood Strips and plates, plasterboard, tiles, stone, granite, marble and metal surfaces
Montage/Einbau auf/in Holzleisten und -platten, Gipsplatten, Fliesen, Stein-, Granit-, Marmor- und Metalloberflächen



PO23V2

CORNER | ECK

LED Strips max. 11 mm

 Silver/Silber
ANODIZED | ELOXIERT

 RAL 9010 White/Weiß
POWDER-COATED | PULVERBESCHICHTET

 RAL 9005 Black/Schwarz
POWDER-COATED | PULVERBESCHICHTET



max. 11 mm

max. 11 mm



OEM



PO23 V2 LED CORNER profile is designed for LED flex-strips with a maximum width of 11 mm and is universally used in interior areas.

The LED profile covers opal/satinised (translucency 65 %) and clear (translucency 85 %) are made of shatter-proof, non-flammable polycarbonate (classification flammability UL94 V-2) and create homogeneous LED lighting conditions with high utilisation of the light output (no pinpoint spots of light, but rather continuous lines of light).

The PO23 V2 LED CORNER profile is dimensioned extremely small and is ideally suited as a LED light source in residential and office furniture, home accessories, display cases, shelves as well as on stairs, walls and ceilings, among other things, due to its low weight.

Das PO23 V2 LED ECK-Profil ist für LED Flexbänder mit einer maximalen Breite von 11 mm konzipiert und wird universell im Innenbereich eingesetzt.

Die LED Profilabdeckungen Opal/satiniert (Lichtdurchlässigkeit 65 %) und Klar (Lichtdurchlässigkeit 85 %) bestehen aus bruchsicherem und schwer brennbarem Polycarbonat (Klassifizierung Brennbarkeit UL94 V-2) und schaffen homogene LED Lichtverhältnisse mit hoher Verwertung der Lichtleistung (keine Lichtpunkte, sondern durchgängige Lichtlinie).

Das PO23 V2 LED ECK-Profil ist ultraklein dimensioniert und aufgrund des geringen Gewichtes unter anderem als ideale LED Lichtquelle in Wohn- und Büromöbeln, Wohnaccessoires, Vitrinen, Regalen sowie an Treppenstufen, Wänden und Decken geeignet.

GALAXY profiles
Perfect Light Lines

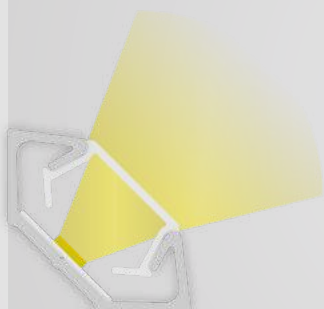

PO23 V2 + C54



PO23 V2 + C55

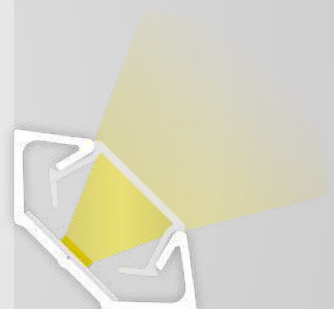

PO23 V2 + C55

- max. 11 mm
- OEM
-

GALAXY profiles
Perfect Light Lines

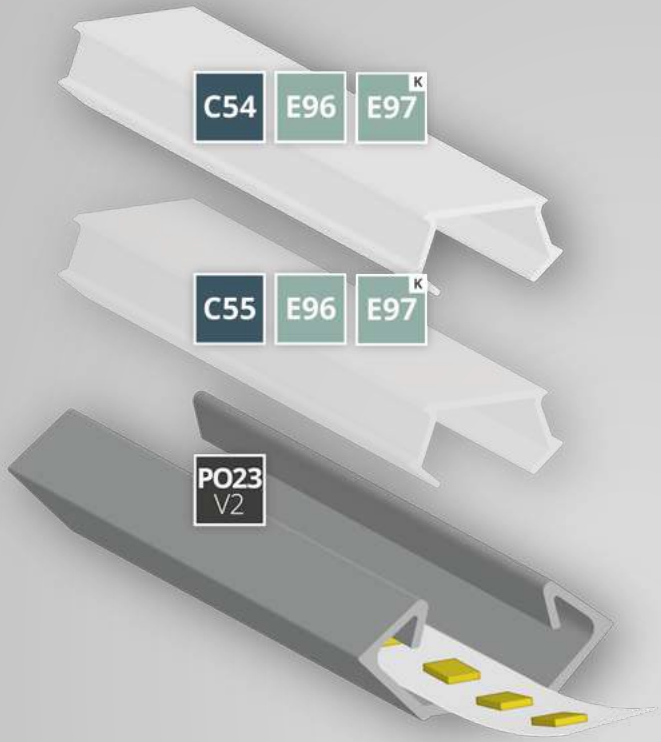
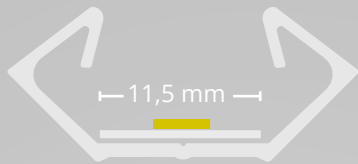

C54 E96 E97^K

C55 E96 E97^K

PO23
V2

COVERS | ABDECKUNGEN

C54 65 % 200cm 8600119 300 cm 8600121

C55 85 % 200 cm 8600120

END CAPS | ENDKAPPEN

E96 E96 8104070 E96 8104072 E96 8104074

E97 E97 8104071 E97 8104073 E97 8104075

PROFILE

PO23 200 cm 8104060 200 cm 8104062 200cm 8104064
V2 300 cm 8104061

Z02 8104050

Z47 8304039 Z47W 8304041 Z47B 8304040

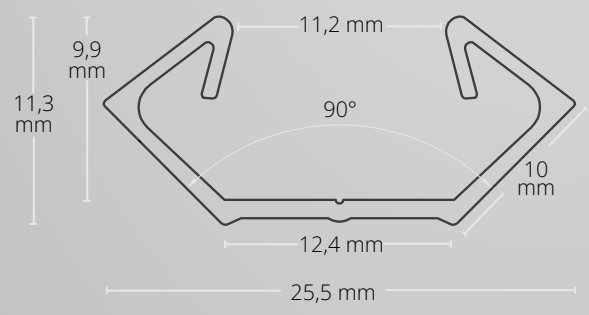

PO23V2 CORNER | ECK

LED Strips max. 11 mm
25,5 mm x 11,3 mm | 129 g/m

200 cm **8104060**
 300 cm **8104061**
 200 cm **8104062**
 200 cm **8104064**



Z02
Mounting Clips
Montageklammer
Sheet steel | Stahlblech
 8104050



Z47
Magnet holder
Magnethalter
PETG
 8304039
 8304041
 8304040



max.
11 mm



OEM



COVERS | ABDECKUNGEN

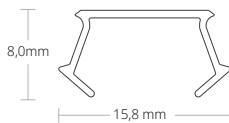

C54 opal | opal | 65 %
PC | 15,8 mm x 8,0 mm
200cm **8600119** 300cm **8600121**

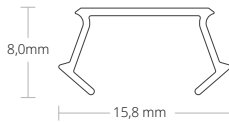

C55 clear | klar | 85 %
PC | 15,8 mm x 8,0 mm
200cm **8600120**

END CAPS | ENDKAPPEN



E96 PVC | 1 PCS/STK
 E96 **8104070**
 E96 **8104072**
 E96 **8104074**



E97 PVC | 1 PCS/STK | Cable/Kabel
 E97 **8104071**
 E97 **8104073**
 E97 **8104075**

PN4

SURFACE | AUFBAU

200 cm | 300 cm

max. 20 mm

OEM

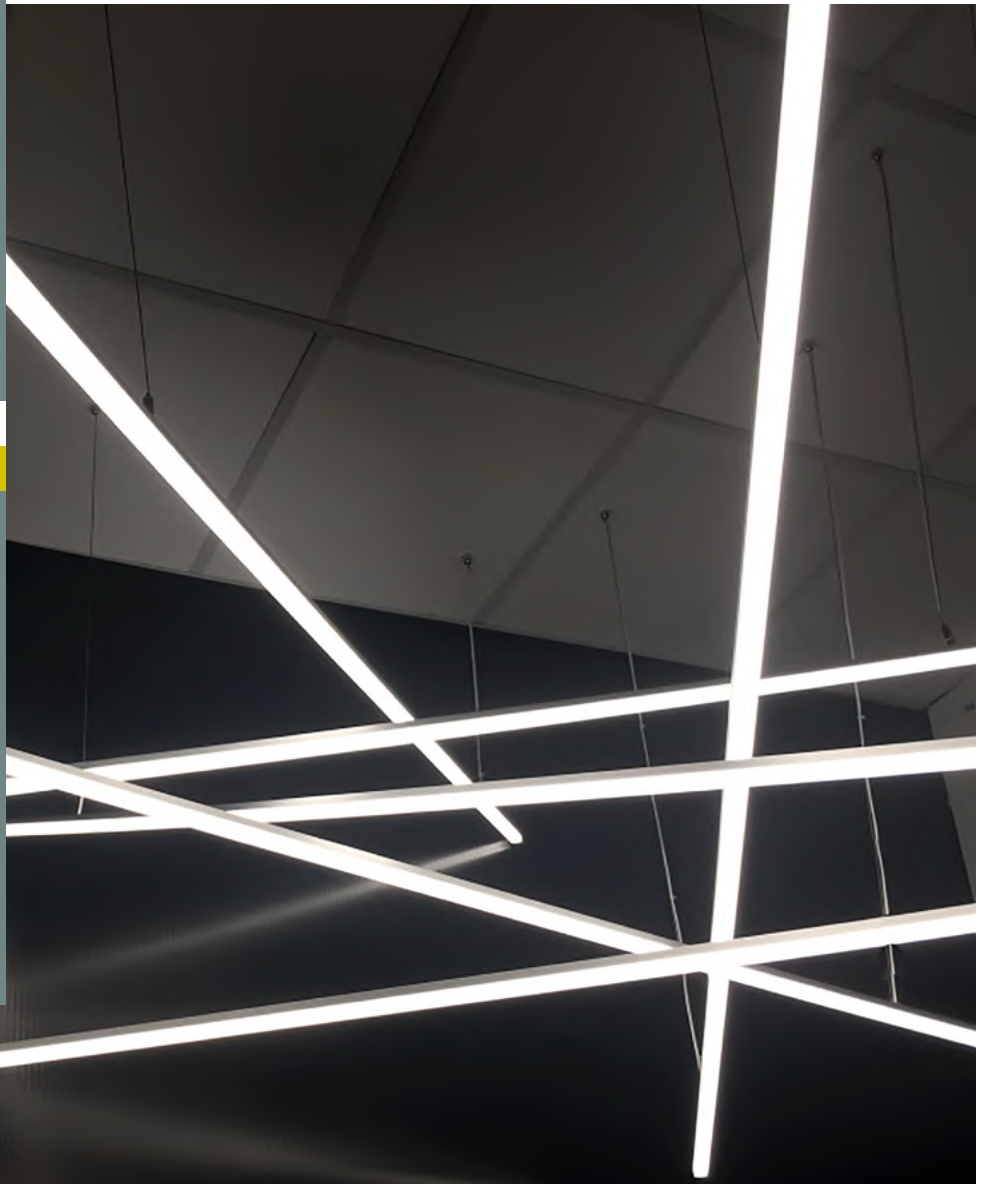

EXTENSION OF SERVICE LIFE
VERLÄNGERUNG LEBENSDAUER

MECHANICAL PROTECTION
MECHANISCHER SCHUTZ

COOLING
KÜHLUNG

HIGH LIGHT UTILISATION
HOHE LICHTVERWERTUNG

HOMOGENEOUS LIGHT
HOMOGENES LICHT

HOMOGENEOUS LIGHT with modular LED light solutions

- Wall, ceiling or floor mounting
Wand-, Decken- oder Bodenmontage
- Residential and office furniture
Wohn- und Büromöbel
- Furniture for business equipment
Möbel für Geschäftsausstattung
- Home accessories
Wohnaccessoires
- Mirrors | Spiegel
- Display cases | Vitrinen
- Shelves | Regale
- Stairs
Treppenstufe
- Balustrades | Balustraden
- Façades, balconies and terraces
Fassaden, Balkone und Terrassen
- Living spaces | Wohnräume
- Offices | Büroräume
- Hotel and gastronomy business
Hotellerie und Gastronomie
- Retail (shop and showcase windows)
Einzelhandel (Shop- und Schaufenster)
- Business areas and showrooms
Geschäftsflächen und Showrooms
- Barber / Beauty / body art studios
Friseur-/Beauty-/Body-Art-Studios
- Halls, foyers and corridors
Hallen, Foyers und Flure
- Wellness and indoor leisure facilities
Wellness- und Indoor-Freizeitanlagen
- Wet rooms | Nasszellen

Mounting/installation on/in wood Strips and plates, plasterboard, tiles, stone, granite, marble and metal surfaces
Montage/Einbau auf/in Holzleisten und -platten, Gipsplatten, Fliesen, Stein-, Granit-, Marmor- und Metalloberflächen



PN4

SURFACE | AUFBAU

flat | flach | LED Strips max. 20 mm

 Silver/Silber
ANODIZED | ELOXIERT

 RAL 9010 White/Weiß
POWDER-COATED | PULVERBESCHICHTET

 RAL 9005 Black/Schwarz
POWDER-COATED | PULVERBESCHICHTET



max. 20 mm

max.
20 mm



OEM



The PN4 LED SURFACE Profile has a narrow design and is designed for LED flexstrips with a maximum width of 20 mm and is universally used in interior areas (in conjunction with the PL10 LED SURFACE Profile and cable universal duct also as a stand-alone LED pendant lamp with cord suspension or as LED lamp fixed with mounting springs). Use the profile for application-specific installations as a recess profile.

These LED opal/satinised (65 % translucency), frosted (75 % translucency), white matt (75 % translucency), clear (85 % translucency) or black matt (25 % translucency) profile covers are made from shatterproof, flame-retardant polycarbonate (flame retardancy classification UL94 V-2) and create uniform LED light with a high transference of the light output. (No points of light, just continuous lines of light)

Covers also available in 6m length!

This LED SURFACE Profile can be fitted with four different plastic covers - flat, high, very high, or round cover. With the flat cover, the light shines in one direction, however, with the high, very high and round cover, the light illuminates the LED strips in three directions (also on the side).

The PN4 LED SURFACE Profile has a large heat sink and can therefore be equipped with strong LED flexstrips. The interior height (distance between LED chips and cover) is coordinated for a continuous light line - no pinpoints of light! It can be used both as a general spatial and object lighting as well as décor and effect lighting.

Das PN4 LED AUFBAU-Profil hat ein schmales Design, ist für LED Flexbänder mit einer maximalen Breite von 20 mm konzipiert und wird universell im Innenbereich (in Verbindung mit PL10 LED AUFBAU-Profil und Kabel-Universalkanal auch als eigenständige LED Hängeleuchte mit Seilabhängung oder als LED Leuchte fixiert mit Montagefedern) eingesetzt. Dieses Alu-Profil kann auch anwendungsspezifisch zum Einbau verwendet werden.

Die LED Profilabdeckungen opal/satiniert (Lichtdurchlässigkeit 65 %), frosted (Lichtdurchlässigkeit 75 %), weiß matt (Lichtdurchlässigkeit 75 %), klar (Lichtdurchlässigkeit 85 %) oder schwarz matt (Lichtdurchlässigkeit 25 %) bestehen aus bruchsicherem und schwer brennbarem Polycarbonat (Klassifizierung Brennbarkeit UL94 V-2) und schaffen homogene LED Lichtverhältnisse mit hoher Verwertung der Lichtleistung. (Keine Lichtpunkte, sondern durchgängige Lichtlinie)

Abdeckungen auch in 6 m verfügbar!

Dieses LED AUFBAU-Profil kann mit vier unterschiedlichen Kunststoffabdeckungen bestückt werden – flache, hohe, sehr hohe oder runde Abdeckung. Bei der flachen Abdeckung strahlt das Licht in eine Richtung, hingegen bei der hohen, sehr hohen und runden Abdeckung leuchtet das Licht der LED Strips in drei Richtungen (auch seitlich).

Das PN4 LED AUFBAU-Profil hat einen großen Kühlkörper und kann somit mit starken LED Flexbändern bestückt werden. Die Innenhöhe (Abstand zwischen LED Chips und Abdeckung) ist für eine durchgängige Lichtlinie abgestimmt - keine Lichtpunkte! Es kann sowohl als allgemeine Raum- und Objektbeleuchtung als auch als Dekor- und Effektbeleuchtung eingesetzt werden.

GALAXY profiles
Perfect Light Lines

PN4 + C30 + ZO3B



PN4 + C33

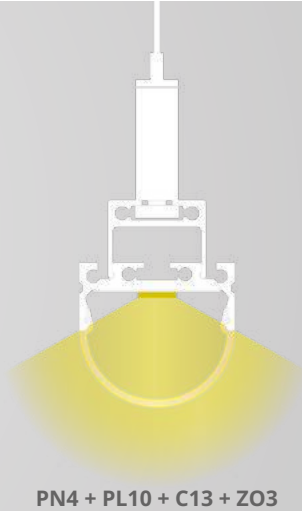

PN4 + PL10 + C13 + ZO3

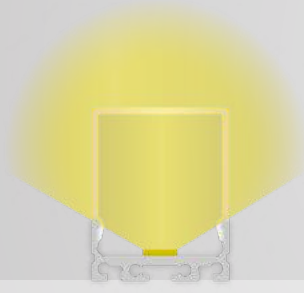

PN4 + C12

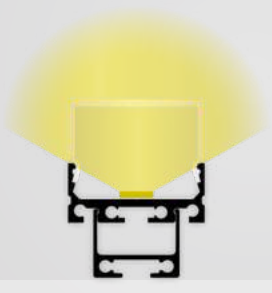

PN4 + PL10 + C11

121

max.
20 mm





OEM



GALAXY profiles
Perfect Light Lines

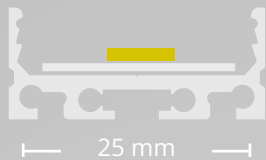

COVERS | ABDECKUNGEN

C30 65 % 200 cm 300 cm
8600077 8600081

C47 75 % 200 cm
8600099

C10 65 % 200cm 600 cm
8600017 8600040

C19 75 % 200 cm
8600036

C36 75 % 200 cm
8600078

C18 85 % 200 cm
8600035

C33 25 % 200 cm 600 cm
8600072 8600073

C11 65 % 200 cm 300 cm
8600018 8600134

C35 85 % 200 cm
8600063



C12 65 % 200 cm
8600019

C31 85 % 200 cm
8600068



C13 65 % 200 cm
8600020

END CAPS | ENDKAPPEN

E43  E43 8201011  E43 8201015  E43 8201016
C10 C19 C36 C18 C33 C30 C47

E44  E44 8202011  E44 8202012  E44 8202013
C11 C35

E45  E45 8203011  E45 8203012  E45 8203013
C12 C31

E46  E46 8204011  E46 8204012  E46 8204013
C13

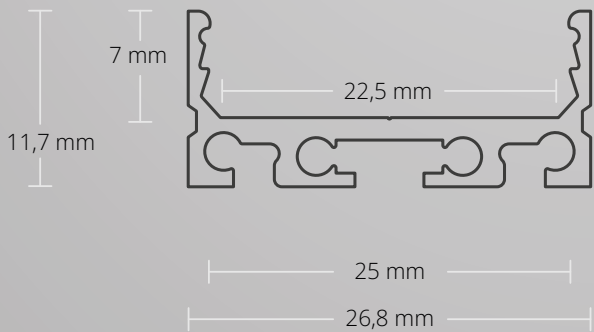

PROFILE

PN4

200 cm 8201012 | 200 cm 8201013 | 200cm 8201014
300 cm 8201010



PL10.1
10 cm 8101085
200 cm 8101080

Z24
8301510
8123413
8123414



Z45
8301517



Z46
8301518

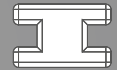

Z50
8123360



Z05
8301501



Z03 8301502 | Z03W 8301512 | Z03B 8301511

**LINEAR LED PENDANT LAMP |
LINEARE LED HÄNGELEUCHTE**

PL10

200cm 8107012 | 200cm 8107013 | 200cm 8107014



Z10
8301504



Z11
8301505



Z05
8301501



Z03 8301502 | Z03W 8301512 | Z03B 8301511

OEM



max.
20 mm



OEM



PN4 SURFACE | AUFBAU

flat | flach | LED Strips max. 20 mm
26,8 mm x 11,7 mm | 225 g/m

- 200 cm **8201012**
- 300 cm **8201010**
- 200 cm **8201013**
- 200 cm **8201014**



PL10.1
Mounting Profile
Montageprofil
10 cm **8101085**
200 cm **8101080**



Z45 | Z46
Connector | Verbinder
Steel | Stahl | 4 PCS/STK
Z45 | 180° **8301517**
Z46 | 90° **8301518**



Z24
Mounting Clips
Montageklammer
Sheet steel | Stahlblech
8301510
8123413
8123414



Z50
Connecting element
Verbindungselement
8123360

More P. 406 | Mehr S. 406

COVERS | ABDECKUNGEN

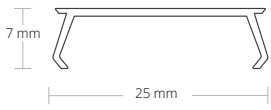

C30 opal | opal | 65 %
PC | 25mm x 7 mm
200cm **8600077** 300cm **8600081**

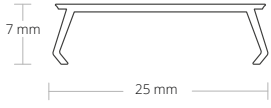

C47 weiß/matt | white/matt | 75 %
PC | 25mm x 7 mm
200cm **8600099**



C10 opal | opal | 65 %
PC | 25,0 mm x 3,8 mm
200cm **8600017** 600cm **8600040**



C19 frosted/gefrostet | 75 %
PC | 25,0 mm x 3,8 mm
200cm **8600036**



C36 white matt/weiß matt | 75 %
PC | 25,0 mm x 3,8 mm
200cm **8600078**



C18 clear | klar | 85 %
PC | 25,0 mm x 3,8 mm
200cm **8600035**

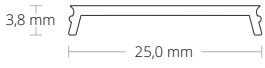
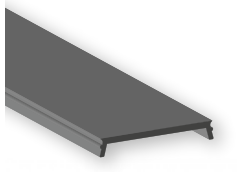

C33 black/matt | schwarz/matt | 25 %
PC | 25,0 mm x 3,8 mm
200cm **8600072** 600cm **8600073**

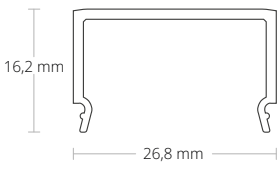

C11 opal | opal | 65 %
PC | 26,8 mm x 16,2 mm
200cm **8600018** 300cm **8600134**

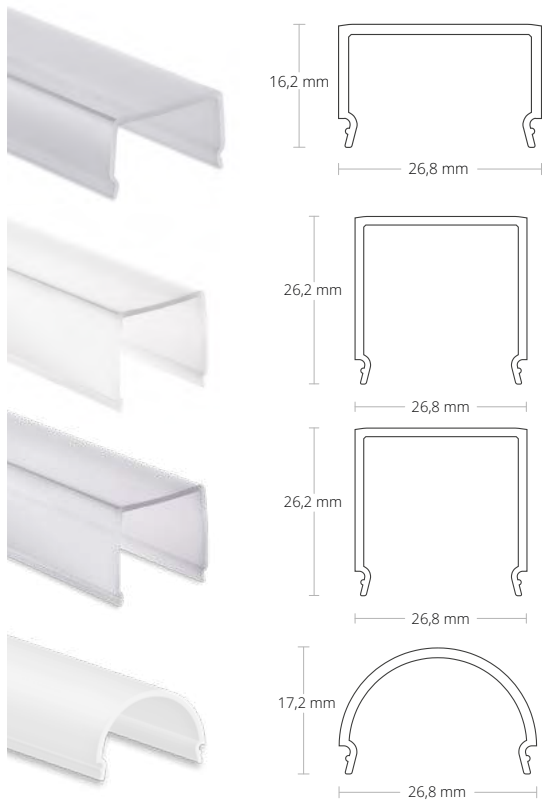

C35 clear | klar | 85 %
PC | 26,8 mm x 16,2 mm
200cm
8600063

C12 opal | opal | 65 %
PC | 26,8 mm x 26,2 mm
200cm
8600019

C31 clear | klar | 85 %
PC | 26,8 mm x 26,2 mm
200cm
8600068

C13 opal | opal | 65 %
PC | 26,8 mm x 17,2 mm
200cm
8600020

max.
20 mm



OEM



END CAPS | ENDKAPPEN

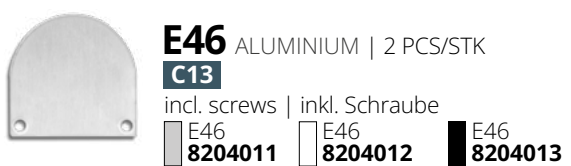
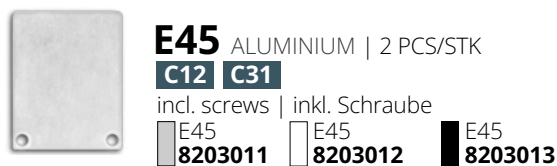
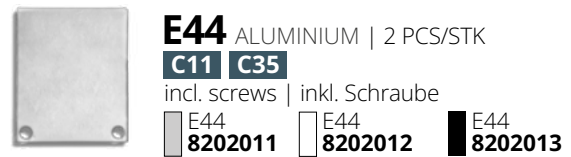
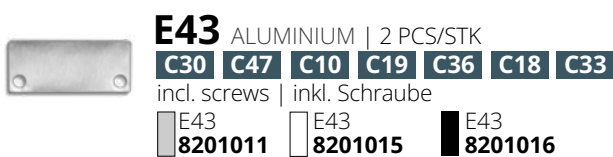

LINEAR LED PENDANT LAMP | LINEARE LED HÄNGELEUCHE



The following accessories can be attached directly to the profile or in conjunction with the PL10 universal duct.

Folgendes Zubehör kann direkt ans Profil angebracht werden oder auch in Verbindung mit den PL10 Universalkanal.

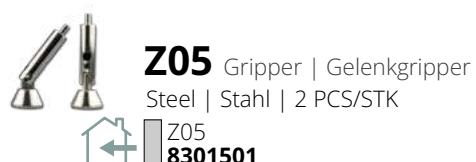

PN5

RECESSED | EINBAU

200 cm

max. 20 mm

OEM

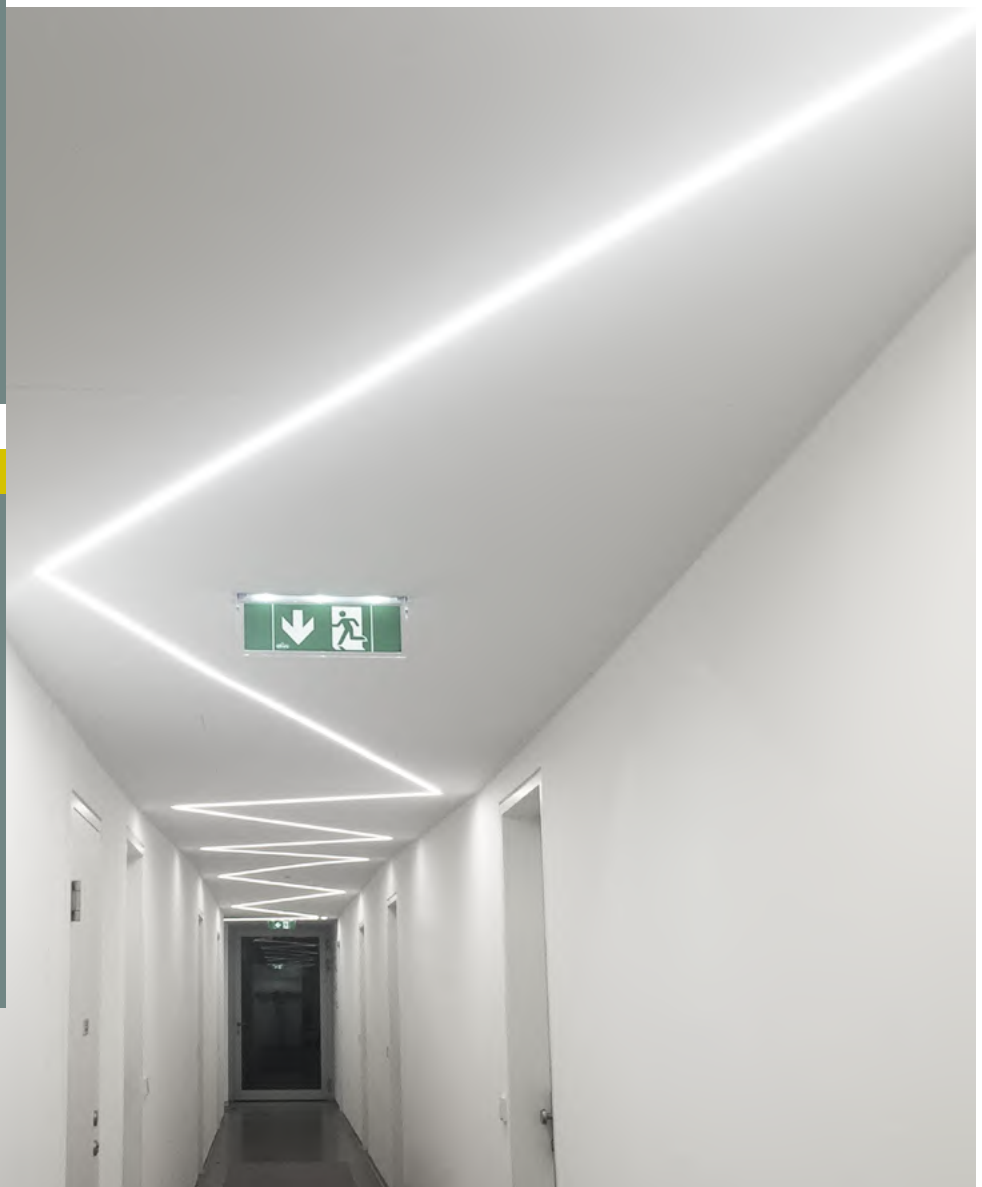

EXTENSION OF SERVICE LIFE
VERLÄNGERUNG LEBENSDAUER

MECHANICAL PROTECTION
MECHANISCHER SCHUTZ

COOLING
KÜHLUNG

HIGH LIGHT UTILISATION
HOHE LICHTVERWERTUNG

HOMOGENEOUS LIGHT
HOMOGENES LICHT

HOMOGENEOUS LIGHT with modular LED light solutions

- Wall, ceiling or floor mounting
Wand-, Decken- oder Bodenmontage
- Residential and office furniture
Wohn- und Büromöbel
- Furniture for business equipment
Möbel für Geschäftsausstattung
- Home accessories
Wohnaccessoires
- Cabinet doors | Schranktüren
- Display cases | Vitrinen
- Shelves | Regale
- Stairs and railings
Treppenstufen und -Geländer
- Balustrades | Balustraden
- Façades, balconies and terraces
Fassaden, Balkone und Terrassen
- Living spaces | Wohnräume
- Offices | Büroräume
- Hotel and gastronomy business
Hotellerie und Gastronomie
- Retail (shop and showcase windows)
Einzelhandel (Shop- und Schaufenster)
- Business areas and showrooms
Geschäftsflächen und Showrooms
- Barber / Beauty / body art studios
Friseur-/Beauty-/Body-Art-Studios
- Halls, foyers and corridors
Hallen, Foyers und Flure
- Wellness and indoor leisure facilities
Wellness- und Indoor-Freizeitanlagen
- Wet rooms | Nasszellen

Mounting/installation on/in wood Strips and plates, plasterboard, tiles, stone, granite, marble and metal surfaces
Montage/Einbau auf/in Holzleisten und -platten, Gipsplatten, Fliesen, Stein-, Granit-, Marmor- und Metalloberflächen



PN5

RECESSED | EINBAU

flat/wings | flach/Flügel | LED Strips max. 20 mm

 Silver/Silber
ANODIZED | ELOXIERT

 RAL 9010 White/Weiß
POWDER-COATED | PULVERBESCHICHTET

 RAL 9005 Black/Schwarz
POWDER-COATED | PULVERBESCHICHTET

max.
20 mm



OEM



max. 20 mm

PN5 LED RECESSED Profile has a narrow design, is designed for LED flexstrips with a maximum width of 20 mm and is universally used in interior areas (optional with the additional cable universal duct PL10).

These LED opal/satinised (65 % translucency), frosted (75 % translucency), white matt (75 % translucency), clear (85 % translucency) or black matt (25 % translucency) profile covers are made from shatterproof, flame-retardant polycarbonate (flame retardancy classification UL94 V-2) and create uniform LED light with a high transference of the light output. (No points of light, just continuous lines of light)

Covers also available in 6m length!

This LED RECESSED Profile can be fitted with four different plastic covers - flat, high, very high, or round cover. With the flat cover, the light shines in one direction, however, with the high, very high and round cover, the light illuminates the LED strips in three directions (also on the side). The interior height (distance between LED chips and cover) is coordinated with the high, very high and round cover for a continuous line of light - no pinpoints of light! The PN5 LED RECESSED Profile has a large heat sink and can therefore be equipped with strong LED flexstrips. It can be used both as a general spatial and object lighting as well as décor and effect lighting. It is ideal for installation in walls and ceilings.

Das PN5 LED EINBAU-Profil hat ein schmales Design, ist für LED Flexbänder mit einer maximalen Breite von 20 mm konzipiert und wird universell im Innenbereich eingesetzt (optional mit dem zusätzlichen Kabel-Universalkanal PL10).

Die LED Profilabdeckungen opal/satiniert (Lichtdurchlässigkeit 65 %), frosted (Lichtdurchlässigkeit 75 %), weiß matt (Lichtdurchlässigkeit 75 %), klar (Lichtdurchlässigkeit 85 %) oder schwarz matt (Lichtdurchlässigkeit 25 %) bestehen aus bruchsicherem und schwer brennbarem Polycarbonat (Klassifizierung Brennbarkeit UL94 V-2) und schaffen homogene LED Lichtverhältnisse mit hoher Verwertung der Lichtleistung. (Keine Lichtpunkte, sondern durchgängige Lichtlinie)

Abdeckungen auch in 6 m verfügbar!

Dieses LED EINBAU-Profil kann mit vier unterschiedlichen Kunststoffabdeckungen bestückt werden – flache, hohe, sehr hohe oder runde Abdeckung. Bei der flachen Abdeckung strahlt das Licht in eine Richtung, hingegen bei der hohen, sehr hohen und runden Abdeckung leuchtet das Licht der LED Strips in drei Richtungen (auch seitlich). Die Innenhöhe (Abstand zwischen LED Chips und Abdeckung) ist bei der hohen, sehr hohen und runden Abdeckung für eine durchgängige Lichtlinie abgestimmt - keine Lichtpunkte! Das PN5 LED EINBAU-Profil hat einen großen Kühlkörper und kann somit mit starken LED Flexbändern bestückt werden. Es kann sowohl als allgemeine Raum- und Objektbeleuchtung als auch als Dekor- und Effektbeleuchtung eingesetzt werden. Es ist ideal zum Einbau in Decken und Wänden.

GALAXY profiles
Perfect Light Lines

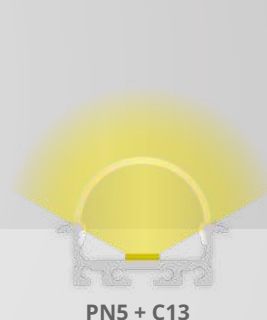
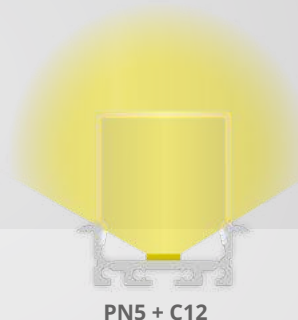
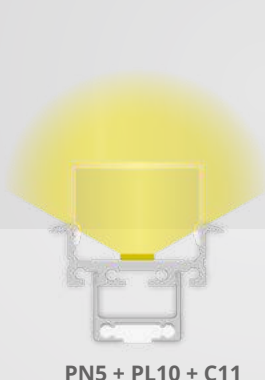

max.
20 mm

OEM





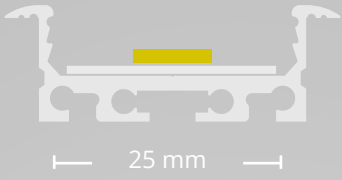









GALAXY profiles
Perfect Light Lines



COVERS | ABDECKUNGEN

C30 65 %	200 cm 8600077	300 cm 8600081
C47 75 %	200 cm 8600099	
C10 65 %	200cm 8600017	600 cm 8600040
C19 75 %	200 cm 8600036	
C36 75 %	200 cm 8600078	
C18 85 %	200 cm 8600035	
C33 25 %	200 cm 8600072	600 cm 8600073
C11 65 %	200 cm 8600018	300 cm 8600134
C35 85 %	200 cm 8600063	
C12 65 %	200 cm 8600019	
C31 85 %	200 cm 8600068	
C13 65 %	200 cm 8600020	

END CAPS | ENDKAPPEN

E43	 E43 8201011	 E43 8201015	 E43 8201016			
C10	C19	C36	C18	C33	C30	C47
E44	 E44 8202011	 E44 8202012	 E44 8202013			
C11	C35					
E45	 E45 8203011	 E45 8203012	 E45 8203013			
C12	C31					
E46	 E46 8204011	 E46 8204012	 E46 8204013			
C13						



PROFILE

PN5 200 cm **8206012** 200 cm **8206014** 200 cm **8206013**

PL10.1 10 cm **8101085** 200 cm **8101080** **Z24** **8301510** **8123413** **8123414**

Z45 **8301517** **Z46** **8301518**

Z44 **8304038**

**LINEAR LED PENDANT LAMP |
LINEARE LED HÄNGELEUCHTE**

PL10 200cm **8107012** 200cm **8107013** 200cm **8107014**

Z10 **8301504** **Z11** **8301505**

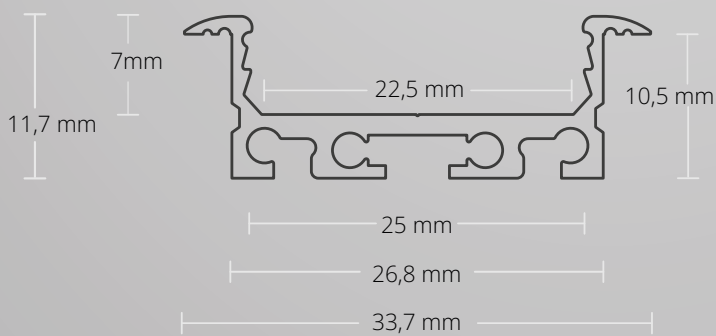

max.
20 mm



OEM



PN5 RECESSED | EINBAU

flat/wings | flach/Flügel | LED Strips max. 20 mm

33,7 mm x 11,7 mm | 236 g/m

200 cm
8206012

200 cm
8206014

200 cm
8206013



PL10.1

Mounting Profile
Montageprofil

10 cm **8101085**
200 cm **8101080**



Z45 | Z46

Connector | Verbinder
Steel | Stahl | 4 PCS/STK

Z45 | 180° **8301517**
Z46 | 90° **8301518**



Z24

Mounting Clips
Montageklammer

Sheet steel | Stahlblech
Z44
8301510
8123413
8123414



Z44

Spring-Gripper |
Montagefeder
Stainless steel |
Edelstahl

Z44
8304038

COVERS | ABDECKUNGEN

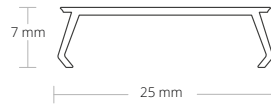

C30 opal | opal | 65 %

PC | 25mm x 7 mm

200cm **8600077** 300cm **8600081**

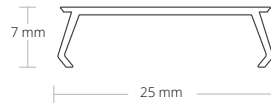

C47 weiß/matt | white/matt | 75 %

PC | 25mm x 7 mm

200cm **8600099**



C10 opal | opal | 65 %

PC | 25,08 mm x 3,81 mm

200cm **8600017** 600cm **8600040**



C19 frosted/gefrostet | 75 %

PC | 25,0 mm x 3,8 mm

200cm **8600036**



C36 white matt/weiß matt | 75 %

PC | 25,0 mm x 3,8 mm

200cm **8600078**



C18 clear | klar | 85 %

PC | 25,0 mm x 3,8 mm

200cm **8600035**

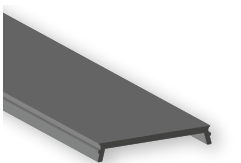

C33 black/matt | schwarz/matt | 25 %

PC | 25,0 mm x 3,8 mm

200cm **8600072** 600cm **8600073**

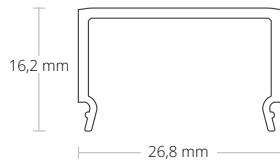

C11 opal | opal | 65 %

PC | 26,8 mm x 16,2 mm

200cm **8600018** 300cm **8600134**

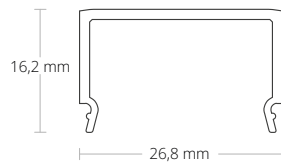

C35 clear | klar | 85 %
PC | 26,8 mm x 16,2 mm
200cm
8600063

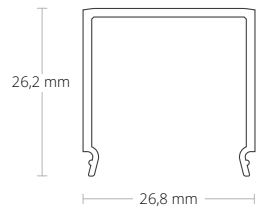

C12 opal | opal | 65 %
PC | 26,8 mm x 26,2 mm
200cm
8600019

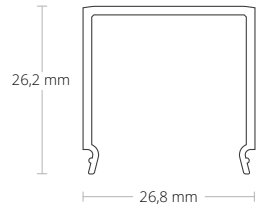

C31 clear | klar | 85 %
PC | 26,8 mm x 26,2 mm
200cm
8600068

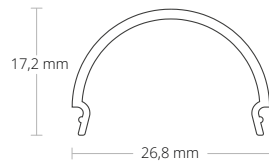

C13 opal | opal | 65 %
PC | 26,8 mm x 17,2 mm
200cm
8600020

max.
20 mm



OEM



END CAPS | ENDKAPPEN



E43 ALUMINIUM | 2 PCS/STK
C30 C47 C10 C19 C36 C18 C33
incl. screws | inkl. Schraube
E43 8201011 E43 8201015 E43 8201016



E44 ALUMINIUM | 2 PCS/STK
C11 C35
incl. screws | inkl. Schraube
E44 8202011 E44 8202012 E44 8202013



E45 ALUMINIUM | 2 PCS/STK
C12 C31
incl. screws | inkl. Schraube
E45 8203011 E45 8203012 E45 8203013



E46 ALUMINIUM | 2 PCS/STK
C13
incl. screws | inkl. Schraube
E46 8204011 E46 8204012 E46 8204013

LINEAR LED PENDANT LAMP | LINEARE LED HÄNGELEUCHE



PL10 universal duct | Universalkanal
for cable | für Kabel
200cm 8107012 200cm 8107013 200cm 8107014



Z10|Z11 Connector | Verbinder
Steel | Stahl | 4 PCS/STK
Z10 | 180° 8301504 Z11 | 90° 8301505

The following accessories can be attached directly to the profile or in conjunction with the PL10 universal duct.

Folgendes Zubehör kann direkt ans Profil angebracht werden oder auch in Verbindung mit den PL10 Universalkanal.

PN6V2

SURFACE | AUFBAU

200 cm

max. 20 mm

OEM

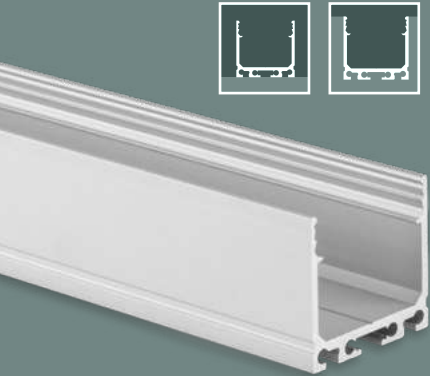

EXTENSION OF SERVICE LIFE
VERLÄNGERUNG LEBENSDAUER

MECHANICAL PROTECTION
MECHANISCHER SCHUTZ

COOLING
KÜHLUNG

HIGH LIGHT UTILISATION
HOHE LICHTVERWERTUNG

HOMOGENEOUS LIGHT
HOMOGENES LICHT

HOMOGENEOUS LIGHT with modular LED light solutions

- Wall, ceiling or floor mounting
Wand-, Decken- oder Bodenmontage
- Residential and office furniture
Wohn- und Büromöbel
- Furniture for business equipment
Möbel für Geschäftsausstattung
- Home accessories
Wohnaccessoires
- Mirrors | Spiegel
- Display cases | Vitrinen
- Shelves | Regale
- Stairs
Treppenstufe
- Balustrades | Balustraden
- Façades, balconies and terraces
Fassaden, Balkone und Terrassen
- Living spaces | Wohnräume
- Offices | Büroräume
- Hotel and gastronomy business
Hotellerie und Gastronomie
- Retail (shop and showcase windows)
Einzelhandel (Shop- und Schaufenster)
- Business areas and showrooms
Geschäftsflächen und Showrooms
- Barber / Beauty / body art studios
Friseur-/Beauty-/Body-Art-Studios
- Halls, foyers and corridors
Hallen, Foyers und Flure
- Wellness and indoor leisure facilities
Wellness- und Indoor-Freizeitanlagen
- Wet rooms | Nasszellen

Mounting/installation on/in wood Strips and plates, plasterboard, tiles, stone, granite, marble and metal surfaces
Montage/Einbau auf/in Holzleisten und -platten, Gipsplatten, Fliesen, Stein-, Granit-, Marmor- und Metalloberflächen



PN6V2

SURFACE | AUFBAU

high | hoch | LED Strips max. 20 mm

 Silver/Silber
ANODIZED | ELOXIERT

 RAL 9010 White/Weiß
POWDER-COATED | PULVERBESCHICHTET

 RAL 9005 Black/Schwarz
POWDER-COATED | PULVERBESCHICHTET



max. 20 mm

max.
20 mm



OEM



The PN6 V2 LED SURFACE Profile has a narrow design and is designed for LED flexstrips with a maximum width of 20 mm and is universally used in interior areas (also as a stand-alone LED pendant lamp with cord suspension or as LED lamp fixed with mounting springs). Use the profile for application-specific installations as a recess profile.

These LED opal/satinised (65 % translucency), frosted (75 % translucency), white matt (75 % translucency), clear (85 % translucency) or black matt (25 % translucency) profile covers are made from shatterproof, flame-retardant polycarbonate (flame retardancy classification UL94 V-2) and create uniform LED light with a high transference of the light output. (No points of light, just continuous lines of light)

Covers also available in 6m length!

This LED SURFACE Profile can be fitted with four different plastic covers - flat, high, very high, or round cover. With the flat cover, the light shines in one direction, however, with the high, very high and round cover, the light illuminates the LED strips in three directions (also on the side). The interior height (distance between LED chips and cover) is coordinated with the high, very high and round cover for a continuous line of light - no pinpoint of light! The PN6 V2 LED SURFACE Profile has a large heat sink and can therefore be equipped with strong LED flexstrips. It can be used both as a general spatial and object lighting as well as décor and effect lighting.

Das PN6 V2 LED AUFBAU-Profil hat ein schmales Design, ist für LED Flexbänder mit einer maximalen Breite von 20 mm konzipiert und wird universell im Innenbereich (auch als eigenständige LED Hängeleuchte mit Seilabhängung oder als LED Leuchte fixiert mit Montagefedern) eingesetzt. Dieses Alu-Profil kann auch anwendungsspezifisch zum Einbau verwendet werden.

Die LED Profilabdeckungen opal/satiniert (Lichtdurchlässigkeit 65 %), frosted (Lichtdurchlässigkeit 75 %), weiß matt (Lichtdurchlässigkeit 75 %), klar (Lichtdurchlässigkeit 85 %) oder schwarz matt (Lichtdurchlässigkeit 25 %) bestehen aus bruchsicherem und schwer brennbarem Polycarbonat (Klassifizierung Brennbarkeit UL94 V-2) und schaffen homogene LED Lichtverhältnisse mit hoher Verwertung der Lichtleistung. (Keine Lichtpunkte, sondern durchgängige Lichtlinie)

Abdeckungen auch in 6 m verfügbar!

Dieses LED AUFBAU-Profil kann mit vier unterschiedlichen Kunststoffabdeckungen bestückt werden – flache, hohe, sehr hohe oder runde Abdeckung. Bei der flachen Abdeckung strahlt das Licht in eine Richtung, hingegen bei der hohen, sehr hohen und runden Abdeckung leuchtet das Licht der LED Strips in drei Richtungen (auch seitlich). Die Innenhöhe (Abstand zwischen LED Chips und Abdeckung) ist bei der hohen, sehr hohen und runden Abdeckung für eine durchgängige Lichtlinie abgestimmt - keine Lichtpunkte! Das PN6 V2 LED AUFBAU-Profil hat einen besonders großen Kühlkörper und kann somit mit sehr starken LED Flexbändern bestückt werden. Es kann sowohl als allgemeine Raum- und Objektbeleuchtung als auch als Dekor- und Effektbeleuchtung eingesetzt werden.

GALAXY profiles
Perfect Light Lines

PN6V2 + C30 + ZO3B

PN6V2 + C12

PN6V2 + PL10 + C11

PN6V2 + C33

PN6V2 + PL10 + C13 + ZO3

133

max.
20 mm

OEM

GALAXY profiles
Perfect Light Lines

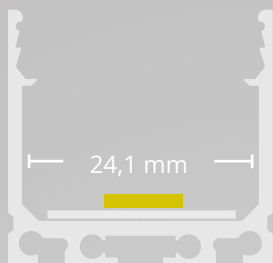

COVERS | ABDECKUNGEN

C30 65 % 200 cm 300 cm
8600077 8600081

C47 75 % 200 cm
8600099

C10 65 % 200cm 600 cm
8600017 8600040

C19 75 % 200 cm
8600036

C36 75 % 200 cm
8600078

C18 85 % 200 cm
8600035

C33 25 % 200 cm 600 cm
8600072 8600073

C11 65 % 200 cm 300 cm
8600018 8600134

C35 85 % 200 cm
8600063

C12 65 % 200 cm
8600019

C31 85 % 200 cm
8600068

C13 65 % 200 cm
8600020

END CAPS | ENDKAPPEN

E47 E47 8301011 E47 8301015 E47 8301016

C10 C19 C36 C18 C33 C30 C47

E48 E48 8302011 E48 8302012 E48 8302013

C11 C35

E49 E49 8303011 E49 8303012 E49 8303013

C12 C31

E50 E50 8304011 E50 8304012 E50 8304013

C13



OEM

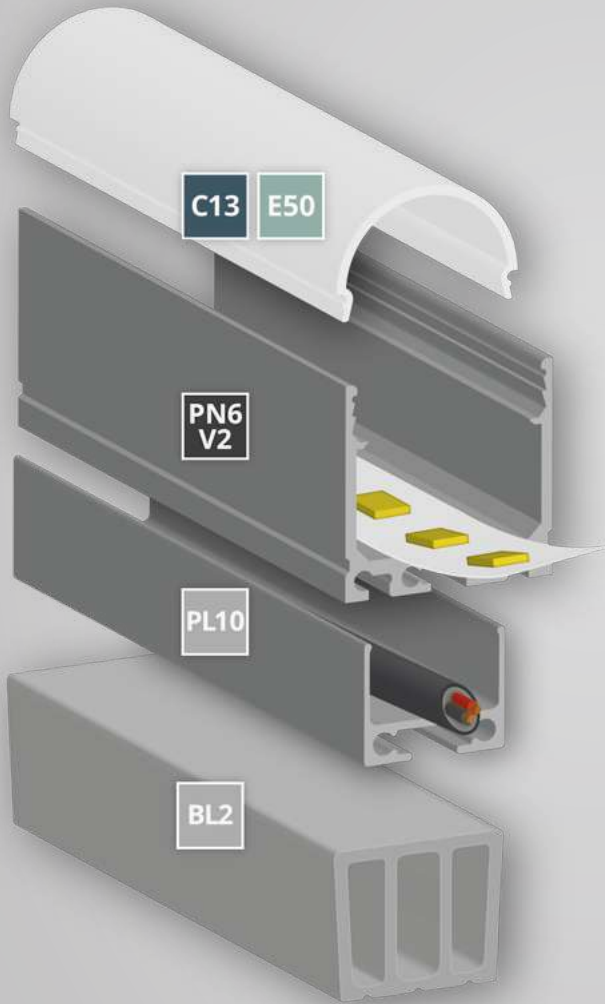

PROFILE

PN6 V2 200 cm 8301017 200 cm 8301018 200cm 8301019

PL10.1 10 cm 8101085 200 cm 8101080 Z24 8301510 8123413 8123414

Z45 8301517 Z46 8301518

Z50 8123360

Z05 8301501

Z03 8301502 Z03W 8301512 Z03B 8301511

BL2 200cm 8123335

LINEAR LED PENDANT LAMP | LINEARE LED HÄNGELEUCHTE

PL10 200cm 8107012 200cm 8107013 200cm 8107014

Z10 8301504 Z11 8301505

Z05 8301501

Z03 8301502 Z03W 8301512 Z03B 8301511

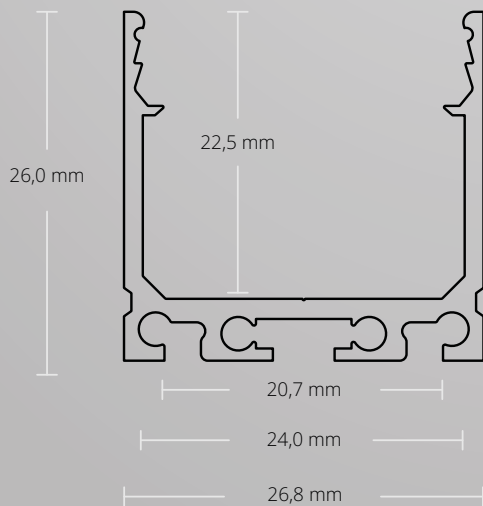

**INSTALLATION INSTRUCTION
INSTALLATIONS MONTAGE**

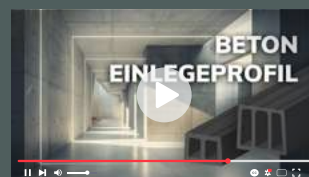

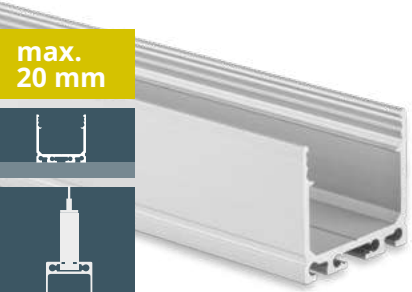

PN6V2 SURFACE | AUFBAU

high | hoch | LED Strips max. 20 mm
26,8 mm x 26,0 mm | 334g/m

- 200 cm **8301017**
- 200 cm **8301018**
- 200 cm **8301019**

- max. 20 mm
- OEM
- Waterproof



PL10.1
Mounting Profile
Montageprofil

- 10 cm **8101085**
- 200 cm **8101080**



Z45 | Z46
Connector | Verbinder
Steel | Stahl | 4 PCS/STK
Z45 | 180° **8301517**
Z46 | 90° **8301518**



Z24
Mounting Clips
Montageklammer
Sheet steel | Stahlblech
 8301510
 8123413
 8123414



Z50
Connecting element
Verbindungselement
 8123360

More P. 406 | Mehr S. 406



BL2

Concrete insert profile | Beton-Einlegeprofil

- 200cm **8123335**

More P. 34 | Mehr S. 34

COVERS | ABDECKUNGEN

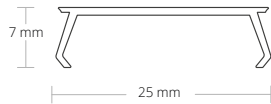

C30 opal | opal | 65 %
PC | 25mm x 7 mm
200cm **8600077** 300cm **8600081**

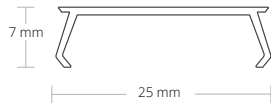

C47 weiß/matt | white/matt | 75 %
PC | 25mm x 7 mm
200cm **8600099**



C10 opal | opal | 65 %
PC | 25,0 mm x 3,8 mm
200cm **8600017** 600cm **8600040**



C19 frosted/gefroestet | 75 %
PC | 25,0 mm x 3,8 mm
200cm **8600036**



C36 white matt/weiß matt | 75 %
PC | 25,0 mm x 3,8 mm
200cm **8600078**



C18 clear | klar | 85 %
PC | 25,0 mm x 3,8 mm
200cm **8600035**

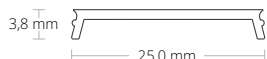
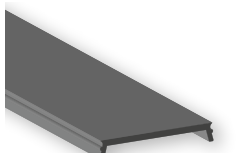

C33 black/matt | schwarz/matt | 25 %
PC | 25,0 mm x 3,8 mm
200cm **8600072** 600cm **8600073**

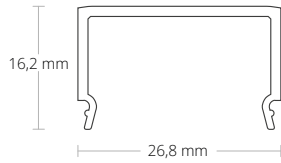

C11 opal | opal | 65 %
 PC | 26,8 mm x 16,2 mm
 200cm 300cm
8600018 8600134

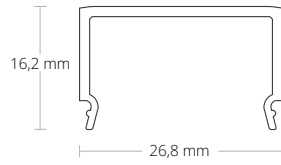

C35 clear | klar | 85 %
 PC | 26,8 mm x 16,2 mm
 200cm
8600063

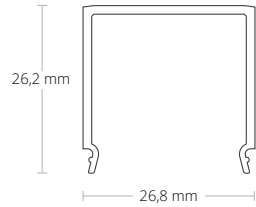

C12 opal | opal | 65 %
 PC | 26,8 mm x 26,2 mm
 200cm
8600019

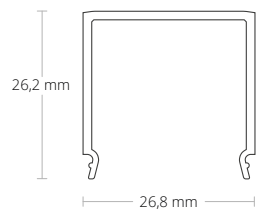

C31 clear | klar | 85 %
 PC | 26,8 mm x 26,2 mm
 200cm
8600068

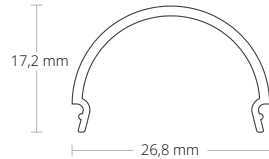

C13 opal | opal | 65 %
 PC | 26,8 mm x 17,2 mm
 200cm
8600020

END CAPS | ENDKAPPEN



E47 ALUMINIUM | 2 PCS/STK
C30 C47 C10 C19 C36 C18 C33
 incl. screws | inkl. Schraube
 E47 8301011 E47 8301015 E47 8301016



E48 ALUMINIUM | 2 PCS/STK
C11 C35
 incl. screws | inkl. Schraube
 E48 8302011 E48 8302012 E48 8302013



E49 ALUMINIUM | 2 PCS/STK
C12 C31
 incl. screws | inkl. Schraube
 E49 8303011 E49 8303012 E49 8303013



E50 ALUMINIUM | 2 PCS/STK
C13
 incl. screws | inkl. Schraube
 E50 8304011 E50 8304012 E50 8304013

LINEAR LED PENDANT LAMP | LINEARE LED HÄNGELEUCHTE



PL10 universal duct | Universalkanal
 for cable | für Kabel
 200cm 8107012 200cm 8107013 200cm 8107014



Z10|Z11 Connector | Verbinder
 Steel | Stahl | 4 PCS/STK
 Z10 | 180° 8301504 Z11 | 90° 8301505

The following accessories can be attached directly to the profile or in conjunction with the PL10 universal duct.
 Folgendes Zubehör kann direkt ans Profil angebracht werden oder auch in Verbindung mit den PL10 Universalkanal.



Z03 Hanging Wire System | Seilabhängung
 Steel | Stahl | 1,5 m | Set | 75 kg
 Z03 8301502 Z03W 8301512 Z03B 8301511



Z05 Gripper | Gelenkgripper
 Steel | Stahl | 2 PCS/STK
 Z05 8301501

max. 20 mm

OEM

PN7V2

RECESSED | EINBAU

200 cm

max. 20 mm

OEM



EXTENSION OF SERVICE LIFE
VERLÄNGERUNG LEBENSDAUER

MECHANICAL PROTECTION
MECHANISCHER SCHUTZ

COOLING
KÜHLUNG

HIGH LIGHT UTILISATION
HOHE LICHTVERWERTUNG

HOMOGENEOUS LIGHT
HOMOGENES LICHT

HOMOGENEOUS LIGHT with modular LED light solutions

- Wall, ceiling or floor mounting
Wand-, Decken- oder Bodenmontage
- Residential and office furniture
Wohn- und Büromöbel
- Furniture for business equipment
Möbel für Geschäftsausstattung
- Home accessories
Wohnaccessoires
- Cabinet doors | Schranktüren
- Display cases | Vitrinen
- Shelves | Regale
- Stairs and railings
Treppenstufen und -Geländer
- Balustrades | Balustraden
- Façades, balconies and terraces
Fassaden, Balkone und Terrassen
- Living spaces | Wohnräume
- Offices | Büroräume
- Hotel and gastronomy business
Hotellerie und Gastronomie
- Retail (shop and showcase windows)
Einzelhandel (Shop- und Schaufenster)
- Business areas and showrooms
Geschäftsflächen und Showrooms
- Barber / Beauty / body art studios
Friseur-/Beauty-/Body-Art-Studios
- Halls, foyers and corridors
Hallen, Foyers und Flure
- Wellness and indoor leisure facilities
Wellness- und Indoor-Freizeitanlagen
- Wet rooms | Nasszellen

Mounting/installation on/in wood Strips and plates, plasterboard, tiles, stone, granite, marble and metal surfaces
Montage/Einbau auf/in Holzleisten und -platten, Gipsplatten, Fliesen, Stein-, Granit-, Marmor- und Metalloberflächen



PN7V2

RECESSED | EINBAU

high/wings | hoch/Flügel | LED Strips max. 20 mm

 Silver/Silber
ANODIZED | ELOXIERT

 RAL 9010 White/Weiß
POWDER-COATED | PULVERBESCHICHTET

 RAL 9005 Black/Schwarz
POWDER-COATED | PULVERBESCHICHTET



max. 20 mm

max.
20 mm



OEM



PN7 V2 LED RECESSED Profile has a narrow design, is designed for LED flexstrips with a maximum width of 20 mm and is universally used in interior areas (optional with the additional cable universal duct PL10).

These LED opal/satinised (65 % translucency), frosted (75 % translucency), white matt (75 % translucency), clear (85 % translucency) or black matt (25 % translucency) profile covers are made from shatterproof, flame-retardant polycarbonate (flame retardancy classification UL94 V-2) and create uniform LED light with a high transference of the light output. (No points of light, just continuous lines of light)

Covers also available in 6m length!

This LED RECESSED Profile can be fitted with four different plastic covers - flat, high, very high, or round cover. With the flat cover, the light shines in one direction, however, with the high, very high and round cover, the light illuminates the LED strips in three directions (also on the side). The interior height (distance between LED chips and cover) is coordinated with the high, very high and round cover for a continuous line of light - no pinpoint of light! The PN7 V2 LED RECESSED Profile has a large heat sink and can therefore be equipped with very strong LED flexstrips. It can be used both as a general spatial and object lighting as well as décor and effect lighting. It is ideal for installation in walls and ceilings.

Das PN7 V2 LED EINBAU-Profil hat ein schmales Design, ist für LED Flexbänder mit einer maximalen Breite von 20 mm konzipiert und wird universell im Innenbereich eingesetzt (optional mit dem zusätzlichen Kabel-Universalkanal PL10).

Die LED Profilabdeckungen opal/satiniert (Lichtdurchlässigkeit 65 %), frosted (Lichtdurchlässigkeit 75 %), weiß matt (Lichtdurchlässigkeit 75 %), klar (Lichtdurchlässigkeit 85 %) oder schwarz matt (Lichtdurchlässigkeit 25 %) bestehen aus bruchsicherem und schwer brennbarem Polycarbonat (Klassifizierung Brennbarkeit UL94 V-2) und schaffen homogene LED Lichtverhältnisse mit hoher Verwertung der Lichtleistung. (Keine Lichtpunkte, sondern durchgängige Lichtlinie)

Abdeckungen auch in 6 m verfügbar!

Dieses LED EINBAU-Profil kann mit vier unterschiedlichen Kunststoffabdeckungen bestückt werden – flache, hohe, sehr hohe oder runde Abdeckung. Bei der flachen Abdeckung strahlt das Licht in eine Richtung, hingegen bei der hohen, sehr hohen und runden Abdeckung leuchtet das Licht der LED Strips in drei Richtungen (auch seitlich). Die Innenhöhe (Abstand zwischen LED Chips und Abdeckung) ist bei der hohen, sehr hohen und runden Abdeckung für eine durchgängige Lichtlinie abgestimmt - keine Lichtpunkte! Das PN7 V2 LED EINBAU-Profil hat einen sehr großen Kühlkörper und kann somit mit sehr starken LED Flexbändern bestückt werden. Es kann sowohl als allgemeine Raum- und Objektbeleuchtung als auch als Dekor- und Effektbeleuchtung eingesetzt werden. Es ist ideal zum Einbau in Decken und Wänden.

GALAXY profiles
Perfect Light Lines



PN7V2+ C10

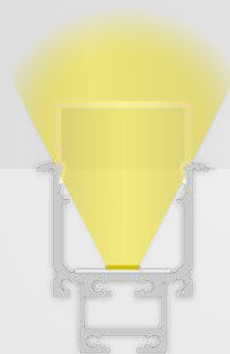

PN7V2 + PL10 + C11

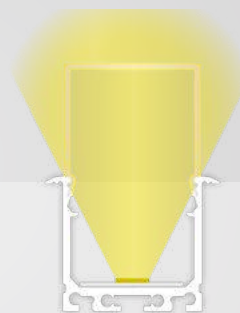

PN7V2 + C12



PN7V2 + C13

max.
20 mm

OEM



GALAXY profiles
Perfect Light Lines

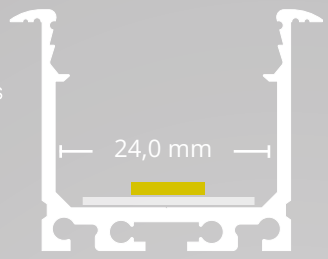

COVERS | ABDECKUNGEN

C30 65 %	200 cm 8600077	300 cm 8600081
C47 75 %	200 cm 8600099	
C10 65 %	200cm 8600017	600 cm 8600040
C19 75 %	200 cm 8600036	
C36 75 %	200 cm 8600078	
C18 85 %	200 cm 8600035	
C33 25 %	200 cm 8600072	600 cm 8600073
C11 65 %	200 cm 8600018	300 cm 8600134
C35 85 %	200 cm 8600063	
C12 65 %	200 cm 8600019	
C31 85 %	200 cm 8600068	
C13 65 %	200 cm 8600020	

END CAPS | ENDKAPPEN

E47	E47 8301011	E47 8301015	E47 8301016			
C10	C19	C36	C18	C33	C30	C47
E48	E48 8302011	E48 8302012	E48 8302013			
C11	C35					
E49	E49 8303011	E49 8303012	E49 8303013			
C12	C31					
E50	E50 8304011	E50 8304012	E50 8304013			
C13						

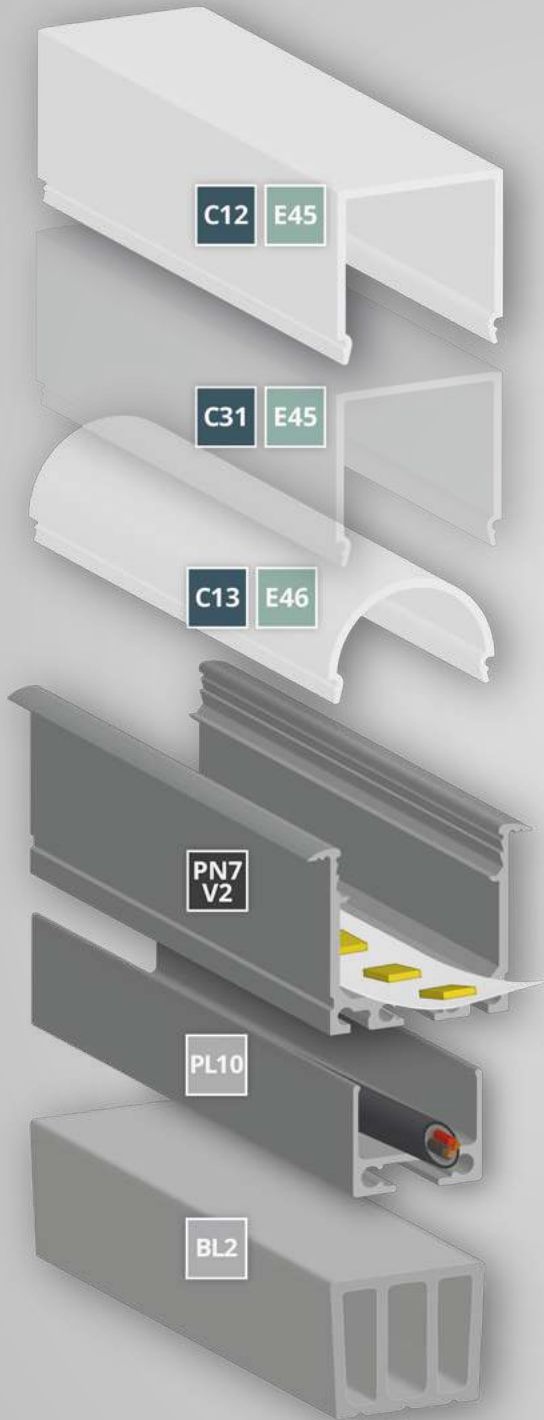

PROFILE

PN7 V2 200 cm 8305015 200 cm 8305016 200 cm 8305017

PL10.1 10 cm 8101085 200 cm 8101080 Z24 8301510 8123413 8123414

Z45 8301517 Z46 8301518

Z44 8304038 BL2 200 cm 8123335

LINEAR LED PENDANT LAMP | LINEARE LED HÄNGELEUCHTE

PL10 200 cm 8107012 200 cm 8107013 200 cm 8107014

Z10 8301504 Z11 8301505



**INSTALLATION INSTRUCTION
INSTALLATIONS MONTAGE**

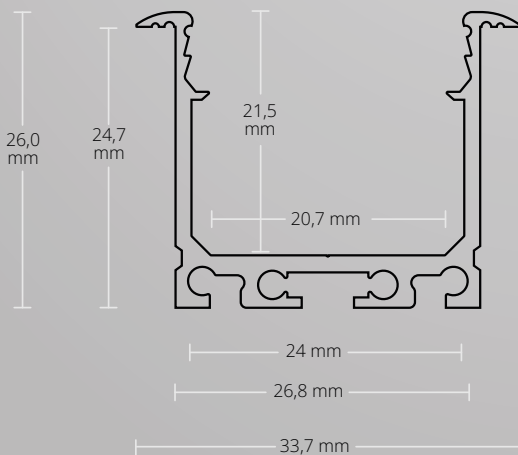

max.
20 mm



OEM

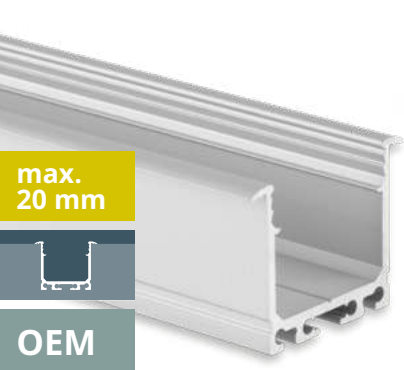

PN7V2 RECESSED | EINBAU

high/wings | hoch/Flügel | LED Strips max. 20 mm
36,7 mm x 26,0 mm | 352 g/m

- 200 cm **8305015**
- 200 cm **8305016**
- 200 cm **8305017**



PL10.1
Mounting Profile
Montageprofil
10 cm **8101085**
200 cm **8101080**



Z45 | Z46
Connector | Verbinder
Steel | Stahl | 4 PCS/STK
Z45 | 180° **8301517**
Z46 | 90° **8301518**



Z24
Mounting Clips
Montageklammer
Sheet steel | Stahlblech
8301510
8123413
8123414



Z44
Spring-Gripper |
Montagefeder
Stainless steel |
Edelstahl
Z44
8304038



BL2
Concrete insert profile | Beton-Einlegeprofil
200cm
8123335

More P. 34 | Mehr S. 34

COVERS | ABDECKUNGEN

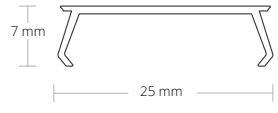

C30 opal | opal | 65 %
PC | 25mm x 7 mm
200cm **8600077** 300cm **8600081**

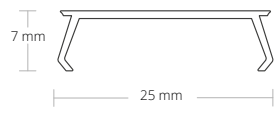

C47 weiß/matt | white/matt | 75 %
PC | 25mm x 7 mm
200cm **8600099**

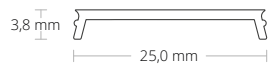

C10 opal | opal | 65 %
PC | 25,08 mm x 3,81 mm
200cm **8600017** 600cm **8600040**

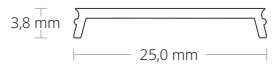
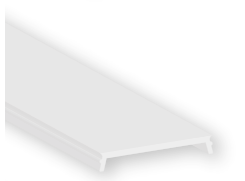

C19 frosted/gefrosetet | 75 %
PC | 25,0 mm x 3,8 mm
200cm **8600036**

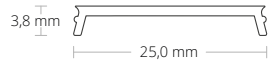

C36 white matt/weiß matt | 75 %
PC | 25,0 mm x 3,8 mm
200cm **8600078**

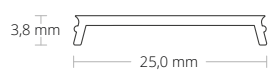

C18 clear | klar | 85 %
PC | 25,0 mm x 3,8 mm
200cm **8600035**

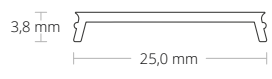
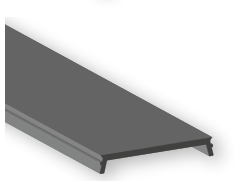

C33 black/matt | schwarz/matt | 25 %
PC | 25,0 mm x 3,8 mm
200cm **8600072** 600cm **8600073**

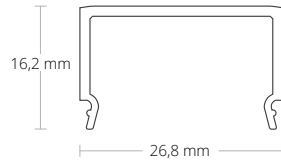

C11 opal | opal | 65 %
PC | 26,8 mm x 16,2 mm
200cm 300cm
8600018 8600134

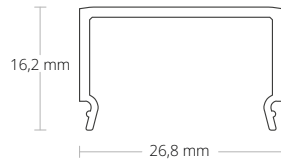

C35 clear | klar | 85 %
PC | 26,8 mm x 16,2 mm
200cm
8600063

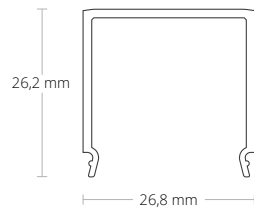

C12 opal | opal | 65 %
PC | 26,8 mm x 26,2 mm
200cm
8600019

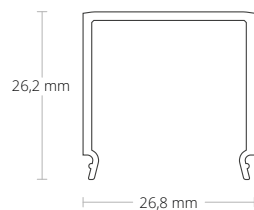

C31 clear | klar | 85 %
PC | 26,8 mm x 26,2 mm
200cm
8600068

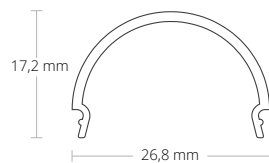

C13 opal | opal | 65 %
PC | 26,8 mm x 17,2 mm
200cm
8600020

END CAPS | ENDKAPPEN



E47 ALUMINIUM | 2 PCS/STK
C30 C47 C10 C19 C36 C18 C33
incl. screws | inkl. Schraube
E47 8301011 E47 8301015 E47 8301016



E48 ALUMINIUM | 2 PCS/STK
C11 C35
incl. screws | inkl. Schraube
E48 8302011 E48 8302012 E48 8302013



E49 ALUMINIUM | 2 PCS/STK
C12 C31
incl. screws | inkl. Schraube
E49 8303011 E49 8303012 E49 8303013



E50 ALUMINIUM | 2 PCS/STK
C13
incl. screws | inkl. Schraube
E50 8304011 E50 8304012 E50 8304013

LINEAR LED PENDANT LAMP | LINEARE LED HÄNGELEUCHE



PL10 universal duct | Universalkanal
for cable | für Kabel
200cm 8107012 200cm 8107013 200cm 8107014



Z10|Z11 Connector | Verbinder
Steel | Stahl | 4 PCS/STK
Z10 | 180° 8301504 Z11 | 90° 8301505

The following accessories can be attached directly to the profile or in conjunction with the PL10 universal duct.
Folgendes Zubehör kann direkt ans Profil angebracht werden oder auch in Verbindung mit den PL10 Universalkanal.

PN8

SURFACE | AUFBAU

200 cm

max. 16 mm

OEM



EXTENSION OF SERVICE LIFE
VERLÄNGERUNG LEBENSDAUER

MECHANICAL PROTECTION
MECHANISCHER SCHUTZ

COOLING
KÜHLUNG

HIGH LIGHT UTILISATION
HOHE LICHTVERWERTUNG

HOMOGENEOUS LIGHT
HOMOGENES LICHT

HOMOGENEOUS LIGHT with modular LED light solutions

- Homes
Wohnräume
- Offices, conference and presentation rooms
Büro-, Konferenz- und Präsentationsräume
- Waiting rooms | Ordinationen
- Business premises and sales floors
Geschäfts- und Verkaufsflächen
- Showrooms
- Hotel and gastronomy
Hotellerie und Gastronomie
- Foyers, corridors and connecting rooms
Foyers, Flure und Verbindungsräume
- Waiting and common rooms
Warte- und Aufenthaltsräume
- Commercial premises (e.g. hair salons)
Gewerbliche Dienstleistungsräumlichkeiten (z. B. Friseursalons etc.)
- Technology and supply rooms
Technik- und Versorgungsräume
- Spa and wellness areas
SPA- und Wellnessbereiche
- Swimming pools
Schwimm-/Hallenbäder
- Car washes
Autowaschanlagen/-waschstraßen
- Outdoor areas
Outdoorbereiche
- Building facades
Gebäudefassaden
- Access paths, paths in parks and green areas
Park-, Grünanlagen und Zufahrten

Mounting/installation on/in wood Strips and plates, plasterboard, tiles, stone, granite, marble and metal surfaces
Montage/Einbau auf/in Holzleisten und -platten, Gipsplatten, Fliesen, Stein-, Granit-, Marmor- und Metalloberflächen



PN8

SURFACE | AUFBAU

LED Strips max. 16 mm

 Silver/Silber
 ANODIZED | ELOXIERT

 RAL 9010 White/Weiß
 POWDER-COATED | PULVERBESCHICHTET

 RAL 9005 Black/Schwarz
 POWDER-COATED | PULVERBESCHICHTET



max. 16 mm

max.
16 mm



OEM



The PN8 LED SURFACE Profile is 200cm long as standard, comes in silver, black and white, is made from high-quality aluminium (anodised) and is designed for use as an RECESSED or SURFACE-MOUNTED profile as well as an independent linear lighting system (in combination with the PL10 cable port or the PL10.1 mounting profile - with or without cable suspension).

The standard flat profile cover made from shatterproof, flame-retardant polycarbonate (classification flammability UL94 V-2 - opal/satinised - 65 % transparency) will completely cover the top of the aluminium profile, and LED flex strips with a maximum width of 16mm can be fixed with adhesive.

Covers also available in 6m length!

Das PN8 LED AUFBAU-Profil wird standardmäßig mit 200 cm Länge und je nach Wunsch auch in den Farben Schwarz und Weiß geliefert, ist aus hochwertigem Aluminium (eloxiert) gefertigt und für den Einsatz sowohl als AUFBAU- und EINBAU-Profil als auch als eigenständiges lineares Leuchtensystem (in Verbindung mit der Kabelschleuse PL10 oder dem Montageprofil PL10.1 – mit und ohne Seilabhängung) konzipiert.

Mit der flachen Standard-Profilabdeckung aus bruchsicherem und schwer brennbarem Polycarbonat (Klassifizierung Brennbarkeit UL94 V-2 - opal/satiniert – Lichtdurchlässigkeit 65 %) wird das ALU-Profil oberseitig komplett abgedeckt und es können LED Flexbänder mit einer max. Breite von 16 mm eingeklebt werden.

Abdeckungen auch in 6 m verfügbar!

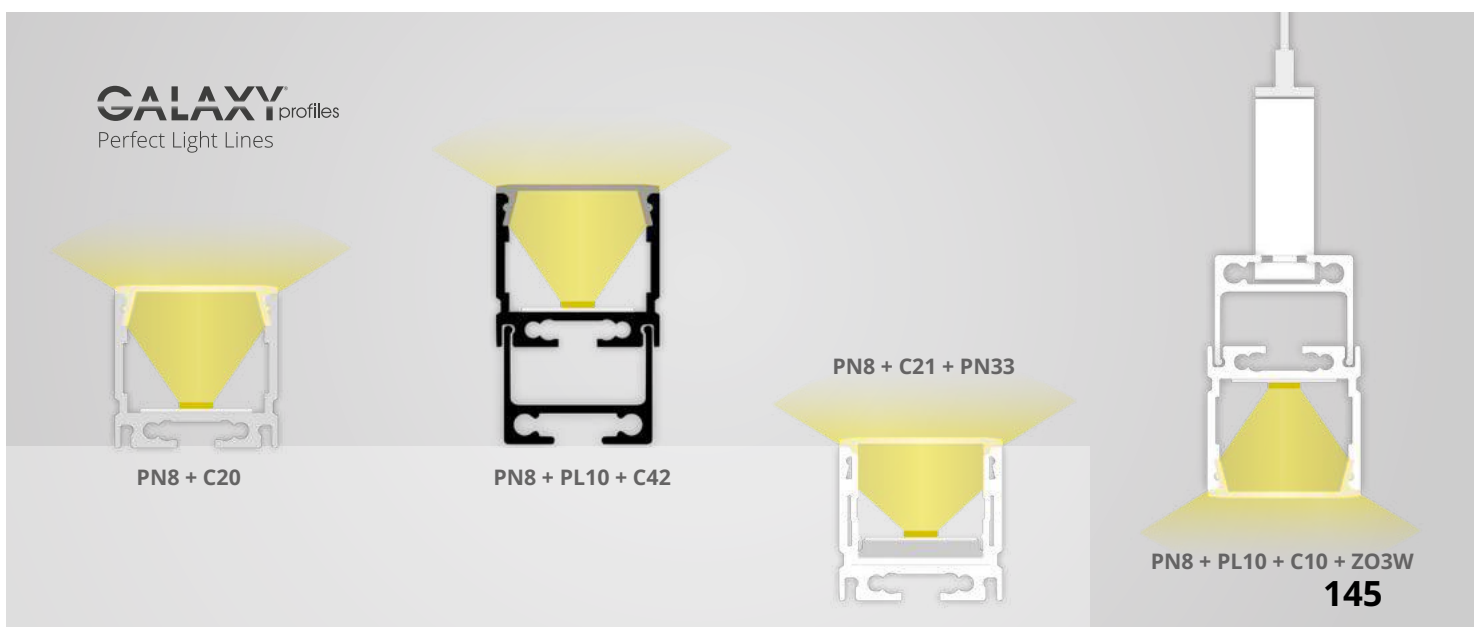

max.
16 mm

OEM

GALAXY profiles

Perfect Light Lines

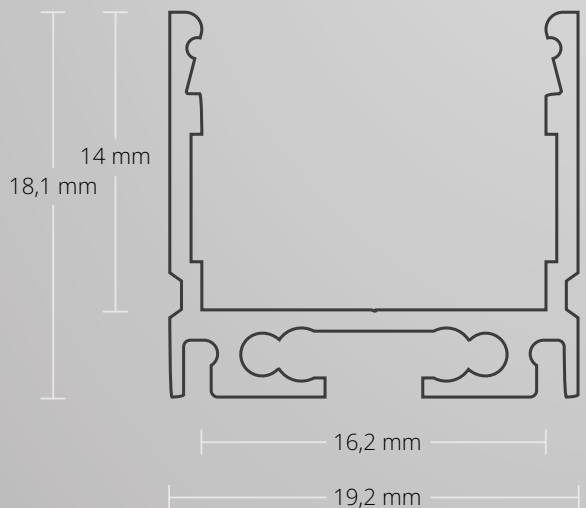
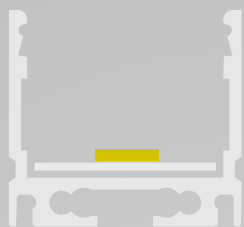

COVERS | ABDECKUNGEN

C20 65 % 200cm 600cm
8600048 8600049

C42 25 % 200cm
8600092

C21 65 % 200cm 260cm
8600050 8600051

PN33 200cm
8105050

END CAPS | ENDKAPPEN

E58 E58 E58 E58
8101027 8101023 8101019

C20
E59 E59 E59 E59
8101028 8101024 8101029

E56 E56
8101025

C21
E57 E57
8101026

PROFILE

PN8 200 cm 200 cm 200cm
8101020 8101021 8101022

PL10.1 10 cm 200 cm
8101085 8101080

Z34 8101010

Z10 8301504 Z11 8301505

Z50 8123360

Z53 8123401

LINEAR LED PENDANT LAMP | LINEARE LED HÄNGELEUCHTE

PL10 200cm 200cm 200cm
8107012 8107013 8107014

Z10 8301504 Z11 8301505

Z05 8301501

Z03 8301502 Z03W 8301512 Z03B 8301511



PN8 SURFACE | AUFBAU

LED Strips max. 16 mm
19,2 mm x 18,1 mm | 188 g/m

- 200 cm 8101020
- 200 cm 8101021
- 200 cm 8101022



PL10.1
Mounting Profile
Montageprofil

- 10 cm 8101085
- 200 cm 8101080



Z10 | Z11
Connector | Verbinder
Steel | Stahl | 4 PCS/STK

- Z10 | 180° 8301504
- Z11 | 90° 8301505



Z34
Mounting Clips
Montageklammer
Sheet steel | Stahlblech

- 8101010



Z53
Connector | Verbinder
flexibel 180°- 45°
2PCS/STK | Steel | Stahl

- 8123401



Z50
Connecting element
Verbindungselement

- 8123360

More P. 406 | Mehr S. 406

max. 16 mm

COVERS | ABDECKUNGEN



C20 opal | opal | 65 %
PC | 19,2 mm x 4,8 mm

- 200cm 8600048
- 600cm 8600049



C42 schwarz/matt | black/matt | 25 %
PC | 19,2 mm x 4,8 mm

- 200cm 8600092

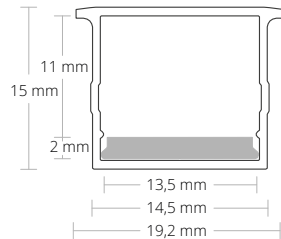

C21 opal | opal | 65 %
PC | 19,2 mm x 15 mm

- 200cm 8600050
- 260cm 8600051

PN33 Profil max. 13 mm

- 200 cm 8105050

END CAPS | ENDKAPPEN



E58 C20 Aluminium | 2 PCS/STK
incl. screws | inkl. Schraube

- E58 8101027
- E58 8101023
- E58 8101019

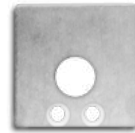

E59 C20 Aluminium | 2 PCS/STK |
Cable/Kabel | incl. screws | inkl. Schraube

- E59 8101028
- E59 8101024
- E59 8101029



E56 C21 Silicone /Silikon | 1 PCS/STK

- E56 8101025



E57 C21 Silicone /Silikon | 1 PCS/STK |
Cable/Kabel

- E57 8101026

LINEAR LED PENDANT LAMP | LINEARE LED HÄNGELEUCHTE



PL10 universal duct | Universalkanal
for cable | für Kabel

- 200cm 8107012
- 200cm 8107013
- 200cm 8107014

The following accessories can be attached directly to the profile or in conjunction with the PL10 universal duct.
Folgendes Zubehör kann direkt ans Profil angebracht werden oder auch in Verbindung mit den PL10 Universalkanal.



Z03 Hanging Wire System | Seilabhängung
Steel | Stahl | 1,5 m | Set | 75 kg

- Z03 8301502
- Z03W 8301512
- Z03B 8301511



Z05 Gripper | Gelenkgripper
Steel | Stahl | 2 PCS/STK

- Z05 8301501

PN10

CORNER | ECK

200 cm | 260 cm

max. 13 mm

OEM



EXTENSION OF SERVICE LIFE
VERLÄNGERUNG LEBENSDAUER

MECHANICAL PROTECTION
MECHANISCHER SCHUTZ

COOLING
KÜHLUNG

HIGH LIGHT UTILISATION
HOHE LICHTVERWERTUNG

HOMOGENEOUS LIGHT
HOMOGENES LICHT

HOMOGENEOUS LIGHT with modular LED light solutions

- Spa and wellness areas
SPA- und Wellnessbereiche
- Building facades
Gebäudefassaden
- Utility rooms/cellars
Waschküchen/Keller
- Damp locations
Feuchträume
- Access paths, paths in parks and
green areas
Park-, Grünanlagen und Zufahrten
- Technology rooms
Technikräume
- Car washes
Autowaschanlagen/-waschstraßen
- Bathrooms/WCs
Bad/WC
- Outdoor areas
Outdoorbereiche
- Kitchens
Küchen

Mounting/installation on/in wood Strips and plates, plasterboard, tiles, stone, granite, marble and metal surfaces
Montage/Einbau auf/in Holzleisten und -platten, Gipsplatten, Fliesen, Stein-, Granit-, Marmor- und Metalloberflächen



PN10

CORNER | ECK

LED Strips max. 13 mm



max. 13 mm

max.
13 mm



OEM



Designed for wet rooms and outdoors!

This PN10 corner cover is supplied in lengths of 200 cm and 260 cm as standard and is designed for LED flex strips with a maximum width of 13 mm. The flex strip is glued to the PN33 aluminum cooling strip (on the narrow upper side). The cooling strip is then inserted into the designated guide. The entire profile system is fixed to the substrate using mounting clips or double-sided adhesive tape.

The LED profile cover (opal/satin - light transmission 65%) is made of shatterproof and flame-retardant polycarbonate (flammability classification UL94 V-2). The distance between the cooling strip with the flexible tape and the cover is chosen so that even thicker LED strips can be used without the individual light points being visible. The result is homogeneous lighting conditions and high light output utilization!

The end caps are made of silicone and are inserted into the profile from the side like a plug. This prevents moisture and water from entering and provides IP66 protection. The end caps with cable glands must be sealed with silicone!

Design für Nasszellen und Outdoor!

Diese ECK-Abdeckung PN10 wird standardmäßig in Längen von 200 cm und 260 cm geliefert und ist für LED Flexbänder mit einer maximalen Breite von 13 mm konzipiert. Das Flexband wird auf den ALU-Kühlstreifen PN33 (auf die schmale Oberseite) geklebt. Danach wird der Kühlstreifen in die vorgesehene Führung eingeschoben. Das gesamte Profilsystem wird mit Montageklammern oder doppelseitigem Klebeband am Untergrund fixiert.

Die LED Profilabdeckung (opal/satiniert - Lichtdurchlässigkeit 65%) besteht aus bruchsicherem und schwer brennbarem Polycarbonat (Klassifizierung Brennbarkeit UL94 V-2). Der Abstand zwischen dem mit dem Flexband beklebten Kühlstreifen und der Abdeckung ist so gewählt, dass auch stärkere LED Strips verwendet werden können, ohne dabei die einzelnen Lichtpunkte zu sehen. Homogene Lichtverhältnisse und hohe Verwertung der Lichtleistung sind das Ergebnis!

Die Endkappen bestehen aus Silikon und werden seitlich wie ein Pfropf in das Profil gesteckt. Dies verhindert das Eindringen von Feuchtigkeit und Wasser und bietet einen IP66 Schutz. Die Endkappen mit Kabeldurchführung müssen mit Silikonabgedichtet werden!

GALAXY profiles
Perfect Light Lines



PN10 + PN33



PN10 + PN33 + PL10.1

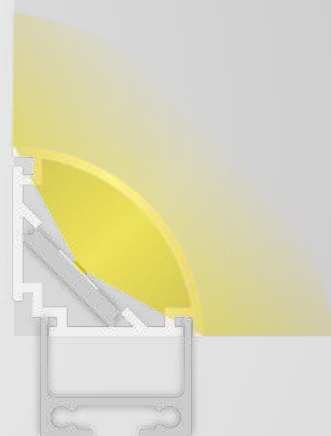

PN10 + PN33 + PL10

max.
13 mm

GALAXY profiles
Perfect Light Lines



OEM

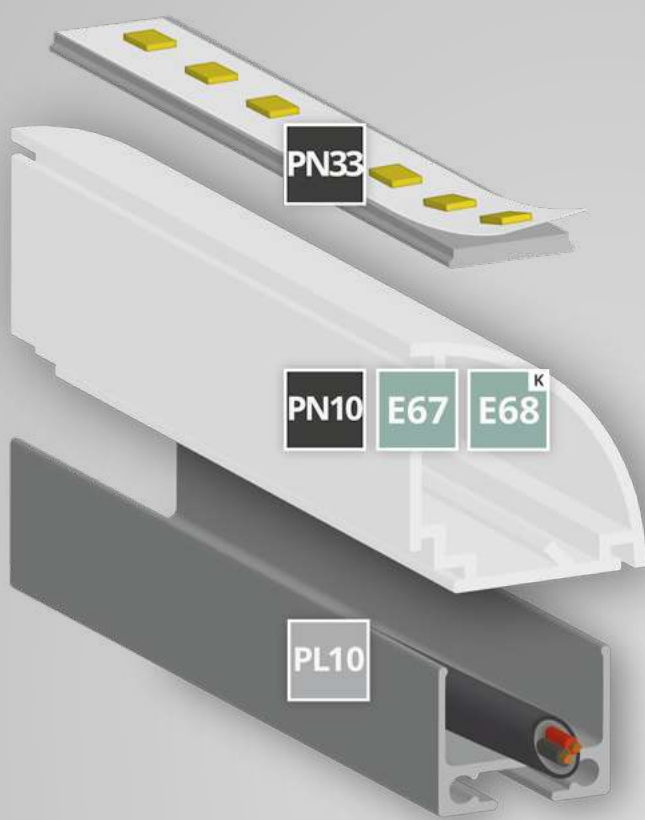

COVERS | ABDECKUNGEN

PN10 65% 200cm 8600043 260cm 8600044

PL10.1 10 cm 8101085
200 cm 8101080

PL10 200cm 8107012 200cm 8107013 200cm 8107014

PROFILE

PN33 200 cm 8105050

END CAPS | ENDKAPPEN

E67 E67 8101075

E68 E68 8101076

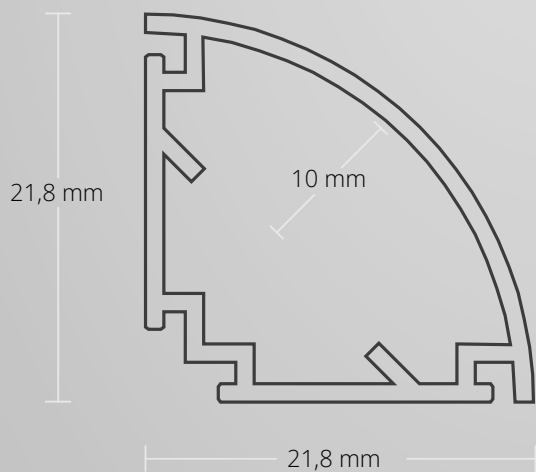



PN10 CORNER | ECK

LED Strips max. 13 mm

PC | opal | opal | 65 % | 21,8 mm x 21,8 mm | 77 g/m

200 cm
8600043

260 cm
8600044



PL10.1

Mounting Profile
Montageprofil

10 cm **8101085**
200 cm **8101080**

max.
13 mm



OEM



PROFILE

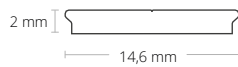

PN33 Aluminium anodized | Aluminium eloxiert

14,6 mm x 2,00 mm | 78 g/m

200cm
8105050

END CAPS | ENDKAPPEN



E67 Silicone /Silikon | 1 PCS/STK

E67
8101075



E68 Silicone /Silikon | 1 PCS/STK |
Cable/Kabel

E68
8101076

LINEAR LED PENDANT LAMP | LINEARE LED HÄNGELEUCHE



PL10 universal duct | Universalkanal
for cable | für Kabel

200cm **8107012** 200cm **8107013** 200cm **8107014**



Z10|Z11 Connector | Verbinder

Steel | Stahl | 4 PCS/STK

Z10 | 180° **8301504** Z11 | 90° **8301505**

PN17V1

SURFACE | AUFBAU

200 cm | 300 cm

max. 30 mm

OEM

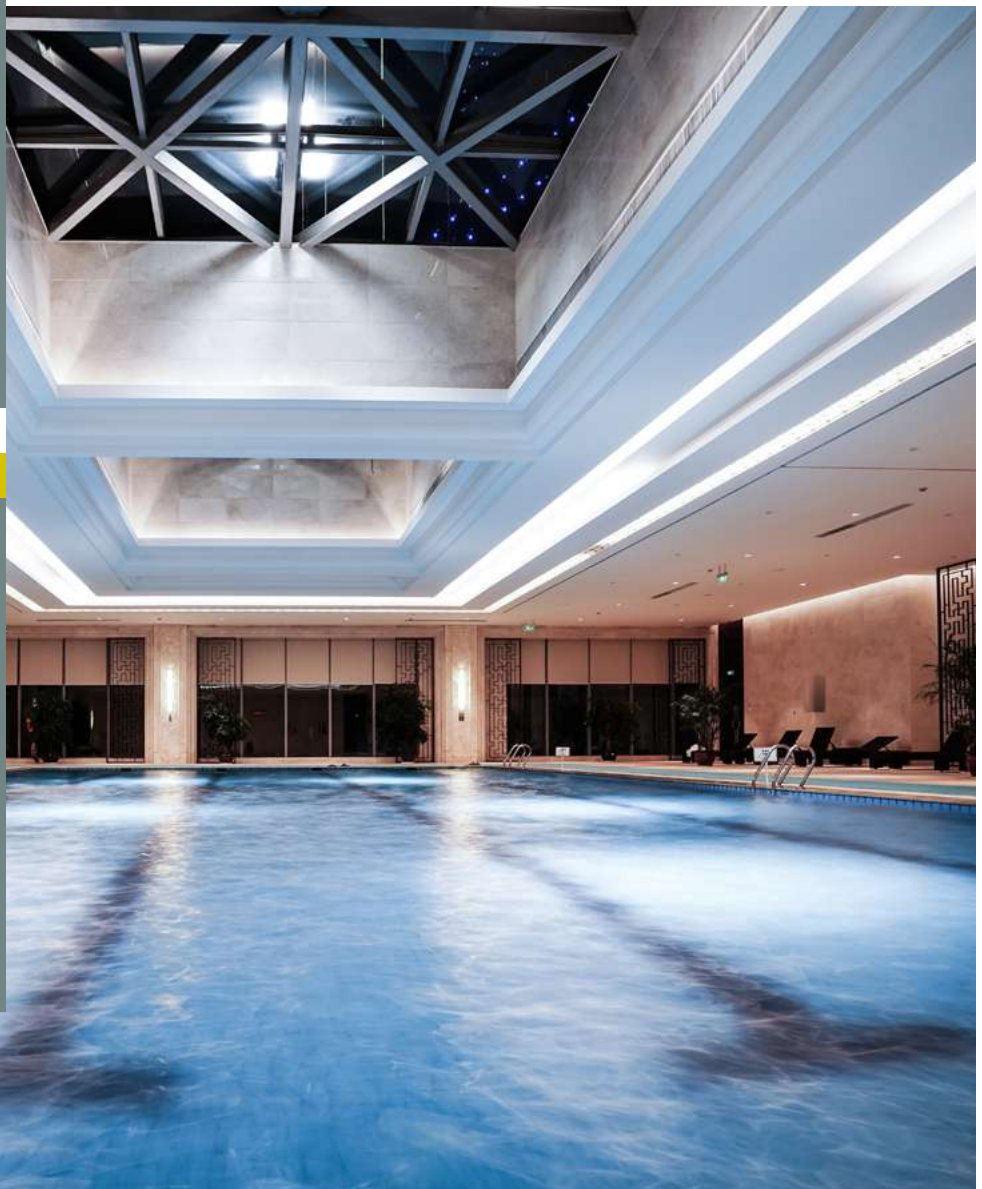
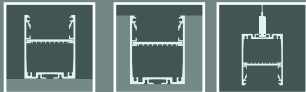

EXTENSION OF SERVICE LIFE
VERLÄNGERUNG LEBENSDAUER

MECHANICAL PROTECTION
MECHANISCHER SCHUTZ

COOLING
KÜHLUNG

HIGH LIGHT UTILISATION
HOHE LICHTVERWERTUNG

HOMOGENEOUS LIGHT
HOMOGENES LICHT

HOMOGENEOUS LIGHT with modular LED light solutions

- Wall, ceiling or floor mounting
Wand-, Decken- oder Bodenmontage
- Residential and office furniture
Wohn- und Büromöbel
- Furniture for business equipment
Möbel für Geschäftsausstattung
- Home accessories
Wohnaccessoires
- Display cases | Vitrinen
- Shelves | Regale
- Balustrades | Balustraden
- Façades, balconies and terraces
Fassaden, Balkone und Terrassen
- Living spaces | Wohnräume
- Offices | Büroräume
- Hotel and gastronomy business
Hotellerie und Gastronomie
- Retail (shop and showcase windows)
Einzelhandel (Shop- und Schaufenster)
- Business areas and showrooms
Geschäftsflächen und Showrooms
- Barber / Beauty / body art studios
Friseur-/Beauty-/Body-Art-Studios
- Halls, foyers and corridors
Hallen, Foyers und Flure
- Wellness and indoor leisure facilities
Wellness- und Indoor-Freizeitanlagen
- Wet rooms | Nasszellen

Mounting/installation on/in wood Strips and plates, plasterboard, tiles, stone, granite, marble and metal surfaces
Montage/Einbau auf/in Holzleisten und -platten, Gipsplatten, Fliesen, Stein-, Granit-, Marmor- und Metalloberflächen



PN17V1

SURFACE | AUFBAU

symmetrical | symmetrisch | LED Strips max. 30 mm

Silver/Silber
POWDER-COATED
PULVERBESCHICHTET

RAL 9003 White/Weiß
POWDER-COATED
PULVERBESCHICHTET

RAL 9005 Black/Schwarz
POWDER-COATED
PULVERBESCHICHTET



max. 30 mm

max.
30 mm



OEM



PN17 V1 LED SURFACE Profile is designed for LED flex-strips with a maximum width of 30 mm and is universally used in interior areas (also as a stand-alone LED pendant lamp with cord suspension). Use the profile for application-specific installations as a recess profile.

The LED profile cover opal/satinised (translucency 65 %) is made of shatter-proof, non-flammable polycarbonate (classification flammability UL94 V-2) and creates homogeneous LED lighting conditions with high utilisation of the light output. The interior height (distance between LED chips and cover) is coordinated for a continuous light line - no pinpoints of light!

Covers also available in 6m length!

The PN17 V1 LED SURFACE Profile is the ideal light source for a general LED spatial and object illumination on walls and ceilings. The well-thought-out design is of special value. This profile can be used very flexibly, because it has an intermediate level, which can be removed by simply pulling it out if necessary.

This LED Luminaire profile can be also equipped with a cord suspension without further adaptation and used as stand-alone LED pendant lamp (or in conjunction with the PL10 cable duct).

Das PN17 V1 LED AUFBAU-Profil ist für LED Flexbänder mit einer maximalen Breite von 30 mm konzipiert und wird universell im Innenbereich (auch als eigenständige LED Hängeleuchte mit Seilabhängung eingesetzt). Dieses Alu-Profil kann auch anwendungsspezifisch zum Einbau verwendet werden.

Die LED Profilabdeckung Opal/satiniert (Lichtdurchlässigkeit 65 %) besteht aus bruch sicherem und schwer brennbarem Polycarbonat (Klassifizierung Brennbarkeit UL94 V-2) und schafft homogene LED Lichtverhältnisse mit hoher Verwertung der Lichtleistung. Die Innenhöhe (Abstand zwischen LED Chips und Abdeckung) ist für eine durchgängige Lichtlinie abgestimmt - keine Lichtpunkte!

Abdeckungen auch in 6 m verfügbar!

Das PN17 V1 LED AUFBAU-Profil ist die ideale Lichtquelle für eine allgemeine LED Raum- und Objektbeleuchtung an Wänden und Decken. Der besondere Mehrwert ist das durchdachte Design. Dieses Profil ist sehr flexibel einsetzbar, denn es weist eine Zwischenebene auf, die bei Bedarf durch einfaches Herausziehen entnommen werden kann.

Dieses LED Leuchtenprofil kann zudem ohne weiterer Adaption (oder in Verbindung mit dem PL10 Kabelkanal) mit einer Seilabhängung versehen und als eigenständige LED Hängeleuchte eingesetzt werden.

GALAXY profiles
Perfect Light Lines

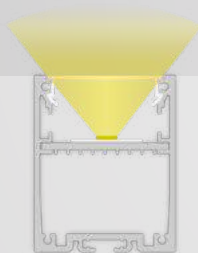

PN17 V1 + C29

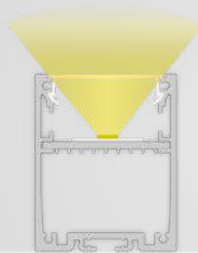

PN17 V1 + C29

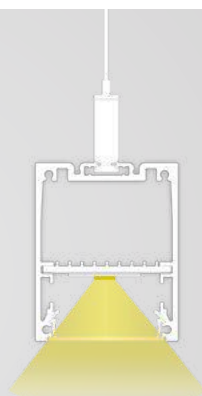

PN17 V1+ C61 + ZO3W

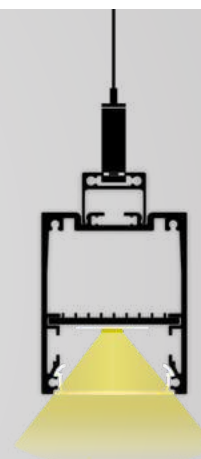

PN17 V1 + C29 + PL10 + ZO3B

max.
30 mm

OEM

GALAXY profiles

Perfect Light Lines

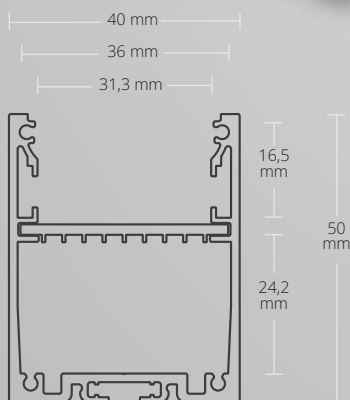
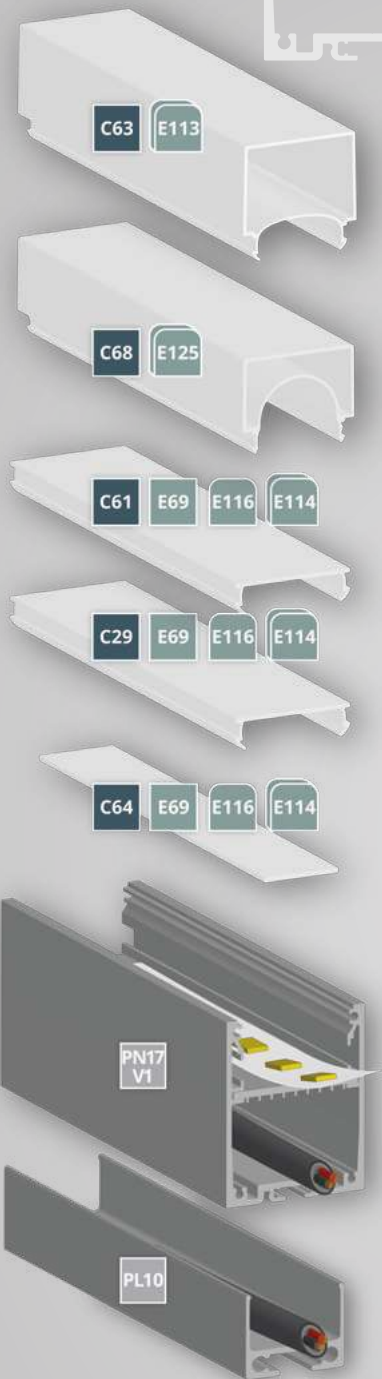
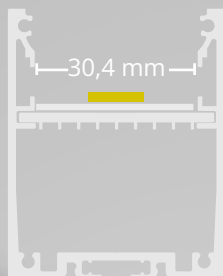

COVERS | ABDECKUNGEN

C29 65 %	200cm 8600059	300cm 8123557
C61 80 %	200cm 8123342	300cm 8506151
C64 75 %	200 cm 8123374	
C63 65 %	200 cm 8123340	300 cm 8123341
C68 65 %	200 cm 8123571	300 cm 8123572

END CAPS | ENDKAPPEN

E69	E69 8102027	E69 8102024	E69 8102023
E113	E113 8123350	E113 8123352	E113 8123351
E114	E114 8123353	E114 8123355	E114 8123354
E116	E116 8123369	E116 8123371	E116 8123370
E125	E125 8192314	E125 8192313	E125 8192312

PROFILE

PN17V1	200 cm 8104020	200 cm 8104022	200cm 8104024
	300 cm 8123337	300 cm 8123339	300cm 8123338

	PL10.1 10 cm 8101085 200 cm 8101080		Z53 8123401
	Z25 8301513		Z26 8301514
	Z27 8301515		Z50 8123360
	Z54 8123417	Z54W 8123416	Z54B 8123415
	Z59 8123434		
	Z03 8301502	Z03W 8301512	Z03B 8301511

LINEAR LED PENDANT LAMP | LINEARE LED HÄNGELEUCHTE

PL10	200cm 8107012	200cm 8107013	200cm 8107014
	Z10 8301504		Z11 8301505
	Z05 8301501		
	Z03 8301502	Z03W 8301512	Z03B 8301511

PN17V1 SURFACE | AUFBAU

symmetrical | symmetrisch | LED Strips max. 30 mm
40 mm x 50 mm | 1.124 g/m

200 cm
8104020

300 cm
8123337

200 cm
8104022

300 cm
8123339

200 cm
8104024

300 cm
8123338



PL10.1
Mounting Profile
Montageprofil
10 cm **8101085**
200 cm **8101080**



Z50
Connecting element
Verbindungselement
8123360
More P. 406 | Mehr S. 406



Fall protection
Absturzsicherung
mit PL10.1
Sheet steel | Stahlblech
8123373

max.
30 mm



OEM



Z25
Connector | Verbinder
Steel | Stahl | 4 PCS/STK
180°
8301513

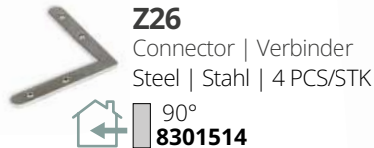

Z26
Connector | Verbinder
Steel | Stahl | 4 PCS/STK
90°
8301514



Z27
Connector | Verbinder
Steel | Stahl | 4 PCS/STK
Side/Seite 90°
8301515



Z53
Connector | Verbinder
flexibel 180°- 45° | 2PCS/STK
Steel | Stahl
8123401



Z54
Connector | Verbinder
90° corner welded | 90° Eck geschweißt |
120x120mm
8123417 **8123416** **8123415**



Z59
Cable inlet cover
Kabeleinlassabdeckung
For round bores with a diameter of 35mm
Für Rundbohrungen mit Durchmesser von 35mm
8123434

COVERS | ABDECKUNGEN



C29 opal | opal | 65 %
PC | 33,2mm x 8,5 mm
200cm 300cm
8600059 **8123557**

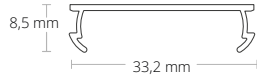

C61 OpalPlus | opalplus | 80 %
PC | 33,2 mm x 8,5 mm
200cm 300cm
8123342 **8506151**

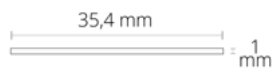

C64 prismatic | prismatisch | 75%
Slide-in cover | Einschubcover
200cm
8123374

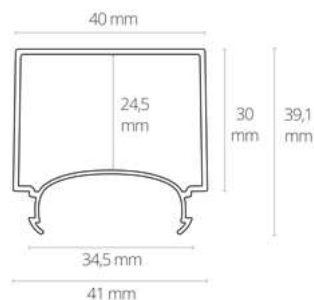

C63 opalplus | OpalPlus | 65%
PC | 40 mm x 39,1 mm
200cm 300cm
8123340 **8123341**

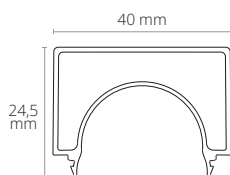

C68 opalplus | OpalPlus | 65%
PC | 40 mm x 39,1 mm
200cm 300cm
8123571 **8123572**

NEW

Thanks to the prismatic cover, the light is evenly distributed and effective glare reduction is guaranteed.

Dank der prismatischen Abdeckung wird das Licht gleichmäßig verteilt und eine effektive Blendungsreduktion gewährleistet.

END CAPS | ENDKAPPEN



E69 Aluminium | 2 PCS/STK

E69 **8102027**
E69 **8102024**
E69 **8102023**

for
C29
C61
C64



E114 Plastic | Kunststoff | 2 PCS/STK

E114 **8123353**
E114 **8123355**
E114 **8123354**

for
C29
C61
C64



E116 Aluminium | 2 PCS/STK

E116 **8123369**
E116 **8123371**
E116 **8123370**

for
C29
C61
C64



E113 Plastic | Kunststoff | 2 PCS/STK

E113 **8123350**
E113 **8123352**
E113 **8123351**

for C63



E125 Plastic | Kunststoff | 2 PCS/STK

E125 **8192314**
E125 **8192313**
E125 **8192312**

NEW

for C68



LINEAR LED PENDANT LAMP | LINEARE LED HÄNGELEUCHE



PL10 universal duct | Universalkanal
for cable | für Kabel

200cm **8107012**
200cm **8107013**
200cm **8107014**



Z10 | Z11 Connector | Verbinder
Steel | Stahl | 4 PCS/STK

Z10 | 180° **8301504**
Z11 | 90° **8301505**



Z03 Hanging Wire System | Seilabhängung
Steel | Stahl | 1,5 m | Set | 75 kg

Z03 **8301502**
Z03W **8301512**
Z03B **8301511**



Z05 Gripper | Gelenkgripper
Steel | Stahl | 2 PCS/STK

Z05 **8301501**





PN17V2

SURFACE | AUFBAU

200 cm | 300 cm

max. 30mm | max. 12mm

OEM

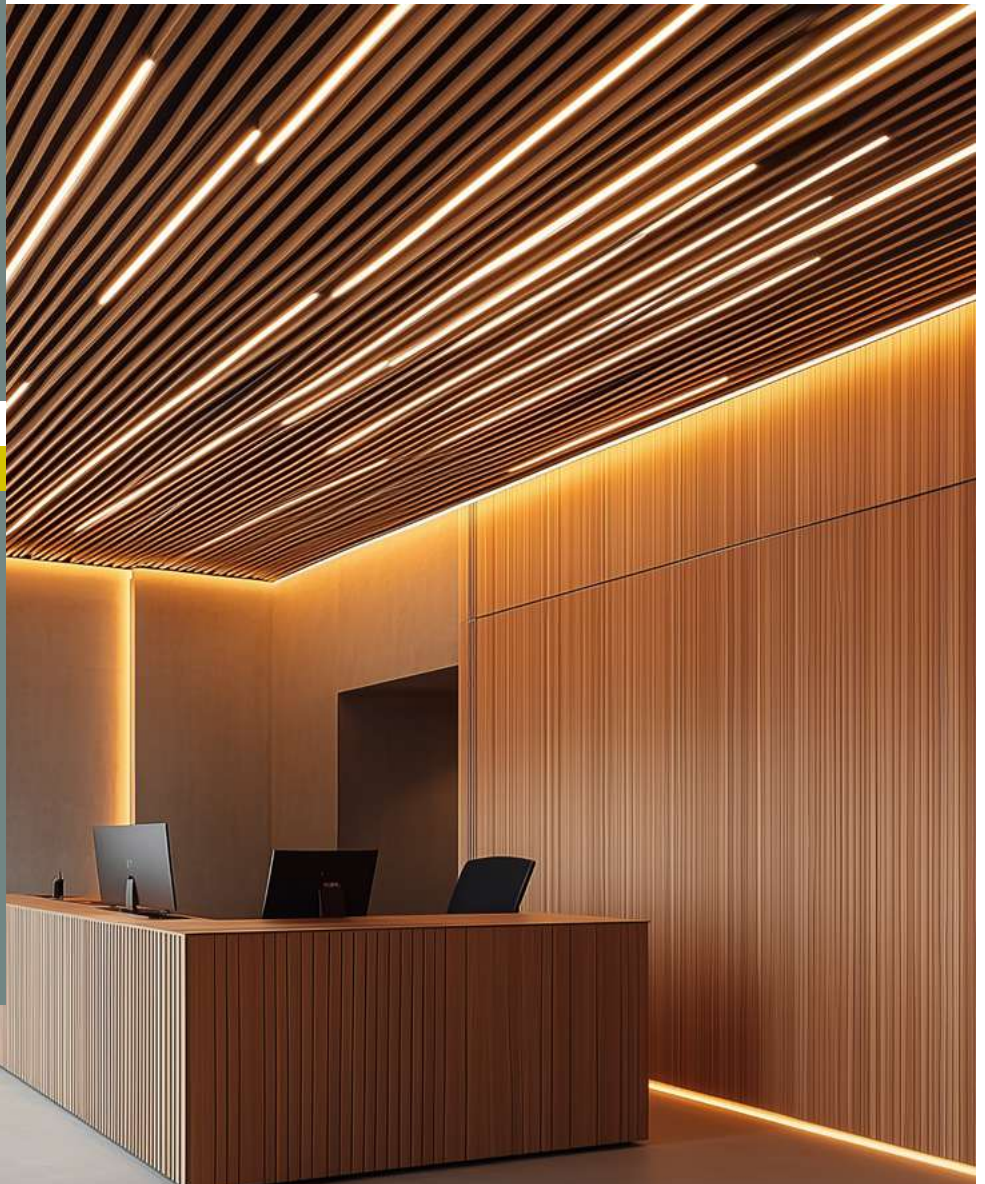
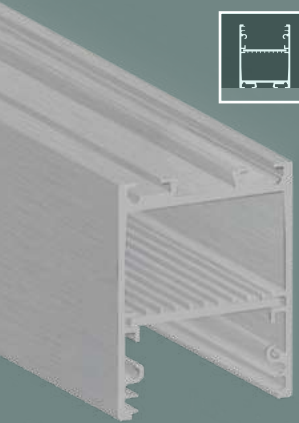
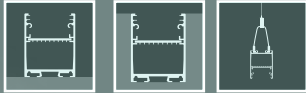

EXTENSION OF SERVICE LIFE
VERLÄNGERUNG LEBENSDAUER

MECHANICAL PROTECTION
MECHANISCHER SCHUTZ

COOLING
KÜHLUNG

HIGH LIGHT UTILISATION
HOHE LICHTVERWERTUNG

HOMOGENEOUS LIGHT
HOMOGENES LICHT

HOMOGENEOUS LIGHT with modular LED light solutions

- Wall, ceiling or floor mounting
Wand-, Decken- oder Bodenmontage
- Residential and office furniture
Wohn- und Büromöbel
- Furniture for business equipment
Möbel für Geschäftsausstattung
- Home accessories
Wohnaccessoires
- Display cases | Vitrinen
- Shelves | Regale
- Balustrades | Balustraden
- Façades, balconies and terraces
Fassaden, Balkone und Terrassen
- Living spaces | Wohnräume
- Offices | Büroräume
- Hotel and gastronomy business
Hotellerie und Gastronomie
- Retail (shop and showcase windows)
Einzelhandel (Shop- und Schaufenster)
- Business areas and showrooms
Geschäftsflächen und Showrooms
- Barber / Beauty / body art studios
Friseur-/Beauty-/Body-Art-Studios
- Halls, foyers and corridors
Hallen, Foyers und Flure
- Wellness and indoor leisure facilities
Wellness- und Indoor-Freizeitanlagen
- Wet rooms | Nasszellen

Mounting/installation on/in wood Strips and plates, plasterboard, tiles, stone, granite, marble and metal surfaces
Montage/Einbau auf/in Holzleisten und -platten, Gipsplatten, Fliesen, Stein-, Granit-, Marmor- und Metalloberflächen



PN17V2

SURFACE | AUFBAU

symmetrical | symmetrisch | LED Strips max. 30 mm / max. 12 mm

Silver/Silber
POWDER-COATED
PULVERBESCHICHTET

RAL 9003 White/Weiß
POWDER-COATED
PULVERBESCHICHTET

RAL 9005 Black/Schwarz
POWDER-COATED
PULVERBESCHICHTET



max. 12mm
max. 30 mm

max.
30 mm

max.
12 mm



OEM



The PN17 V2 illuminates both directly and indirectly. Flex strips up to 30 mm wide are suitable for direct lighting and LED stripes with a maximum width of 12 mm are suitable for indirect lighting. The luminaire profile is attached directly to the ceiling using cable suspension or mounting.

The LED profile cover opal/satinised (translucency 65 %) is made of shatter-proof, non-flammable polycarbonate (classification flammability UL94 V-2) and creates homogeneous LED lighting conditions with high utilisation of the light output. The interior height (distance between LED chips and cover) is coordinated for a continuous light line - no pinpoint of light! The prismatic slide-in cover makes a major contribution to glare reduction and the lens covers ensure unique beam angles.

Covers also available in 6m length!

The PN17 V2 luminaire profile casts your rooms in a new light. In addition to the standard downward lighting, indirect upward lighting is also possible. Whether in the office, in the catering trade or in the living area, the luminaire profile provides the perfect lighting with the various selectable covers. In addition to good illumination of the work surface, the indirect lighting creates a pleasant ambience and sets a lighting accent.

Das PN17 V2 leuchtet sowohl direkt als auch indirekt. Für die direkte Beleuchtung kommen Flexbänder von bis zu 30 mm Breite infrage und für die indirekte Beleuchtung eignen sich LED Flexbänder mit einer maximalen Breite von 12 mm. Das Leuchtenprofil wird mittels Seilabhängung oder Montage direkt an der Decke befestigt.

Mehrere Covers stehen für die direkte und indirekte Beleuchtung zur Auswahl. Die LED Profilabdeckung Opal/satiniert (Lichtdurchlässigkeit 65 %) besteht aus bruchsicherem und schwer brennbarem Polycarbonat (Klassifizierung Brennbarkeit UL94 V-2) und schafft homogene LED Lichtverhältnisse mit hoher Verwertung der Lichtleistung. Das prismatische Einschubcover trägt stark zur Blendungsreduzierung bei und die Linsencover sorgen für einzigartige Abstrahlwinkel.

Abdeckungen auch in 6 m verfügbar!

Das PN17 V2 Leuchten-Profil lässt Ihre Räumlichkeiten in einem neuen Licht erscheinen. Neben der standardmäßigen Beleuchtung nach unten ist ebenfalls eine indirekte Beleuchtung nach oben möglich. Egal ob im Büro, in der Gastronomie oder im Wohnbereich, das Leuchten-Profil sorgt mit den verschiedenen wählbaren Covers für die perfekte Beleuchtung. Neben einer guten Ausleuchtung der Arbeitsfläche sorgt die indirekte Beleuchtung für ein angenehmes Ambiente und setzt einen Lichtakzent.

GALAXY profiles
Perfect Light Lines

PN17 V2 + C29

PN17 V2 + C61

PN17 V2 + C67

PN17 V2 + C63

PN17 V2 + C61 + C2 + ZO4 **159**

max. 30 mm

max. 12 mm

OEM

GALAXY profiles
Perfect Light Lines

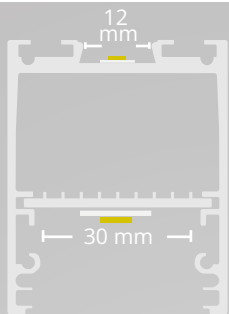

COVERS | ABDECKUNGEN

C29 65 %	200cm 8600059	300cm 8123557		
C61 80 %	200cm 8123342	300cm 8506151		
C1 65 %	200cm 8600004	250cm 8600026	300cm 8600080	600cm 8600037
C2 85 %	200cm 8600003	250cm 8600135	300cm 8600136	
C58 75 %	200cm 8600154			
C63 65 %	200 cm 8123340	300 cm 8123341		
C64 75 %	200 cm 8123374			
C68 65 %	200 cm 8123571	300 cm 8123572		

END CAPS | ENDKAPPEN

E69	E69 8102027	E69 8102024	E69 8102023
E114	E114 8123353	E114 8123355	E114 8123354
E116	E116 8123369	E116 8123371	E116 8123370
E113	E113 8123350	E113 8123352	E113 8123351
E125	E125 8192314	E125 8192313	E125 8192312

PROFILE

PN17V2	200 cm 8123363	200 cm 8123365	200cm 8123364
	300 cm 8123366	300 cm 8123368	300cm 8123367

Z25 8301513	Z26 8301514
Z27 8301515	Z50 8123360
Z53 8123401	Z55 8123420 8123419 8123418
Z52 8123362 8123377 8123376	Z59 8123434

Z04 8123372	Z04W 8123386	Z04B 8123387
----------------	-----------------	-----------------

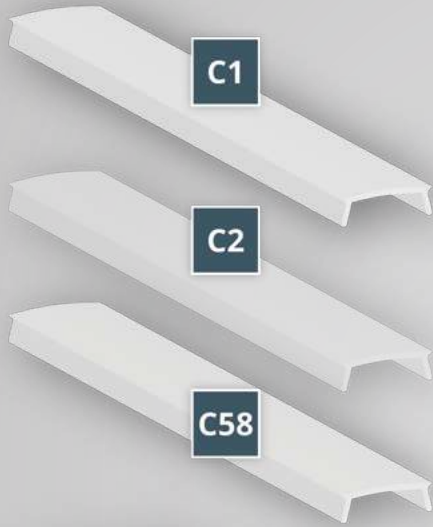

COVERS | ABDECKUNGEN

C65 80 % 117,6 cm
8123385

C66 80 % 117,6 cm
8123384

C67 80 % 117,6 cm
8123383



Platform Cooling Strip
Podestkühlstreifen
117,6 cm 8123378

for/für
C65, C66, C67

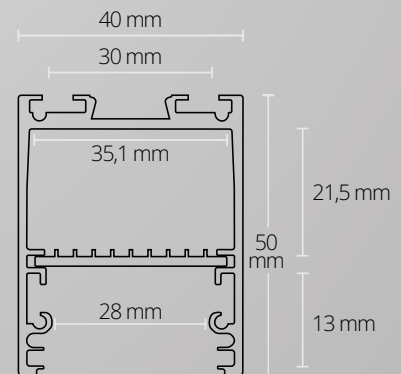

max. 30 mm

max. 12 mm

OEM



PN17V2 SURFACE | AUFBAU

symmetrical | symmetrisch | LED Strips max. 30 mm | max.12mm
40 mm x 50 mm | 1035 g/m

200 cm **8123363**
 300 cm **8123366**
 200 cm **8123365**
 300 cm **8123368**
 200 cm **8123364**
 300 cm **8123367**

Z25
Connector | Verbinder
Steel | Stahl | 4 PCS/STK

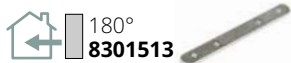

Z26
Connector | Verbinder
Steel | Stahl | 4 PCS/STK



Z27
Connector | Verbinder
Steel | Stahl | 4 PCS/STK



Z50
Connecting element
Verbindungselement
8123360



More P. 406 | Mehr S. 406

Z55
Connector | Verbinder
90° corner welded | 90° Eck geschweißt | 120x120mm

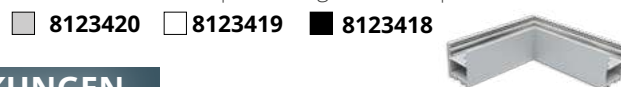

Z53
Connector | Verbinder
flexibel 180°- 45°
2PCS/STK
Steel | Stahl
8123401



Z52
Mounting clips | Montageklammer
Spring steel | Federstahl
8123362
8123377
8123376



Z59
Cable inlet cover
Kabeleinlassabdeckung
For round bores with a diameter of 35 mm
Für Rundbohrungen mit Durchmesser von 35mm
8123434



COVERS | ABDECKUNGEN



C29 opal | opal | 65 %
PC | 33,2 mm x 8,5 mm
200cm 300cm
8600059 8123557



C61 opalplus | OpalPlus | 80 %
PC | 33,2 mm x 8,5 mm
200cm 300cm
8123342 8506151



C1 opal | opal | 65 %
PC | 13,8 mm x 4,4 mm
200cm 250cm 300cm 600cm
8600004 8600026 8600080 8600037



C2 clear | klar | 85 %
PC | 13,8 mm x 4,4 mm
200cm 250cm 300cm
8600003 8600135 8600136



C58 white/matt | weiß/matt | 75 %
PC | 13,8 mm x 4,4 mm
200cm
8600154

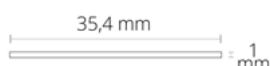

C64 prismatic | prismatisch | 75%
Slide-in cover | Einschubcover
200cm
8123374

Thanks to the prismatic cover, the light is evenly distributed and effective glare reduction is guaranteed.

Dank der prismatischen Abdeckung wird das Licht gleichmäßig verteilt und eine effektive Blendungsreduktion gewährleistet.

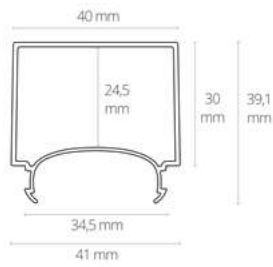

C63 opalplus | OpalPlus | 65%
 PC | 40 mm x 39,1 mm
 200cm 300cm
8123340 8123341



NEW

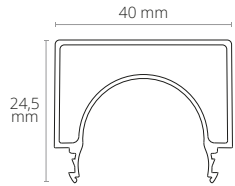

C68 opalplus | OpalPlus | 65%
 PC | 40 mm x 39,1 mm
 200cm 300cm
8123571 8123572

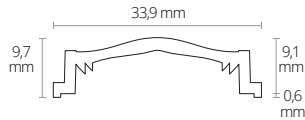

C65 double-asymmetrical | doppel-asymmetrisch
 PMMA | 33,9 mm x 9,7 mm
 117,6 cm
8123385

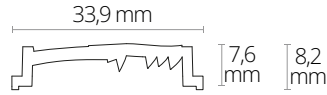
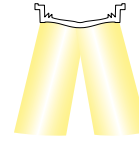

C66 25° | asymmetrical | asymmetrisch
 PMMA | 33,9 mm x 8,2 mm
 117,6 cm
8123384

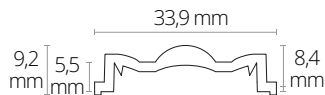
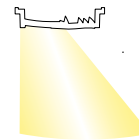

C67 60°
 PMMA | 33,9 mm x 9,2 mm
 117,6 cm
8123383



END CAPS | ENDKAPPEN



E69 Aluminium | 2 PCS/STK
 E69 8102027 E69 8102024
 E69 8102023 for C29, C61, C64, C65, C66, C67



E116 Aluminium | 2 PCS/STK
 E116 8123369 E116 8123371
 E116 8123370 for C29, C61, C64, C65, C66, C67



E125 Plastic | Kunststoff | 2 PCS/STK
 E125 8192314 E125 8192313 **NEW**
 E125 8192312 for C68



E114 Plastic | Kunststoff | 2 PCS/STK
 E114 8123353 E114 8123355
 E114 8123354 for C29, C61, C64, C65, C66, C67



E113 Plastic | Kunststoff | 2 PCS/STK
 E113 8123350 E113 8123352
 E113 8123351 for C63



LINEAR LED PENDANT LAMP | LINEARE LED HÄNGELEUCHTE



Z04 Hanging Wire System | Seilabhängung
 Steel | Stahl | 3 m | Set | 75 kg
 Z04 8123372 Z04W 8123386 Z04B 8123387

INSTALLATION INSTRUCTION
INSTALLATIONS MONTAGE

max. 30 mm

max. 12 mm



OEM



Platform Cooling Strip
 Podestkühlstreifen
for/für C65, C66, C67
 117,6 cm **8123378**

PN27

200 cm | 300 cm

max. 12 mm / 30 mm

OEM



NEW TO OUR RANGE
IM SORTIMENT

EXTENSION OF SERVICE LIFE
VERLÄNGERUNG LEBENSDAUER

MECHANICAL PROTECTION
MECHANISCHER SCHUTZ

COOLING
KÜHLUNG

HIGH LIGHT UTILISATION
HOHE LICHTVERWERTUNG

HOMOGENEOUS LIGHT
HOMOGENES LICHT

HOMOGENEOUS LIGHT with modular LED light solutions

- Wall, ceiling or floor mounting
Wand-, Decken- oder Bodenmontage
- Residential and office furniture
Wohn- und Büromöbel
- Furniture for business equipment
Möbel für Geschäftsausstattung
- Home accessories
Wohnaccessoires
- Mirrors | Spiegel
- Cabinet doors | Schranktüren
- Display cases | Vitrinen
- Shelves | Regale
- Stairs and railings
Treppenstufen und -Geländer
- Balustrades | Balustraden
- Façades, balconies and terraces
Fassaden, Balkone und Terrassen
- Living spaces | Wohnräume
- Offices | Büroräume
- Hotel and gastronomy business
Hotellerie und Gastronomie
- Retail (shop and showcase windows)
Einzelhandel (Shop- und Schaufenster)
- Business areas and showrooms
Geschäftsflächen und Showrooms
- Barber / Beauty / body art studios
Friseur-/Beauty-/Body-Art-Studios
- Halls, foyers and corridors
Hallen, Foyers und Flure
- Wellness and indoor leisure facilities
Wellness- und Indoor-Freizeitanlagen
- Wet rooms | Nasszellen

Mounting/installation on/in wood Strips and plates, plasterboard, tiles, stone, granite, marble and metal surfaces
Montage/Einbau auf/in Holzleisten und -platten, Gipsplatten, Fliesen, Stein-, Granit-, Marmor- und Metalloberflächen



PN27

LUMINAIR | LEUCHTEN

symmetrical | symmetrisch | LED Strips max. 30 mm / max. 12 mm

 Silver/Silber
ANODIZED | ELOXIERT

 RAL 9010 White/Weiß
POWDER-COATED | PULVERBESCHICHTET

 RAL 9005 Black/Schwarz
POWDER-COATED | PULVERBESCHICHTET



max. 30 mm

max. 12 mm

The PN27 provides both direct and indirect lighting. LED flex strips with a maximum width of 12 mm are suitable for direct lighting, while 30 mm strips are ideal for indirect lighting. The light profile can be attached using the mounting brackets with cable suspension or by mounting it directly to the ceiling.

The high-quality aluminum profile ensures even illumination, but also scores points with its attractive appearance and effective heat dissipation. Thanks to its light weight and stable design, the profile is very robust. It can be combined perfectly with other accessories, such as various covers or end caps, to create a harmonious overall look.

The PN27 profile is ideal for use in offices, reception areas, or hotels. It provides uniform, glare-free illumination while adding architectural accents that give the room a modern and elegant look.

Das PN27 leuchtet sowohl direkt als auch indirekt. Für die direkte Beleuchtung eignen sich LED Flexbänder mit einer maximalen Breite von 12 mm und für die indirekte Beleuchtung mit 30 mm. Das Leuchtenprofil kann mit den Montagebügeln mittels Seilabhängung oder durch eine Montage direkt an der Decke befestigt werden.

Das hochwertige Aluminiumprofil sorgt für eine flächige Ausleuchtung, punktet aber auch mit einer ansprechenden Optik und einer effektiven Wärmeableitung. Dank des leichten Gewichts und der stabilen Bauform ist das Profil sehr robust. Es lässt sich hervorragend mit weiterem Zubehör, wie verschiedenen Covers oder Endkappen kombinieren, um ein stimmiges Gesamtziel zu schaffen.

Das PN27 Profil eignet sich bestens für die Verwendung in Büros, Empfangsbereichen oder Hotels. Es sorgt für eine gleichmäßige, blendfreie Ausleuchtung und setzt zugleich architektonische Akzente, die den Raum modern und elegant wirken lassen.

GALAXY profiles
Perfect Light Lines

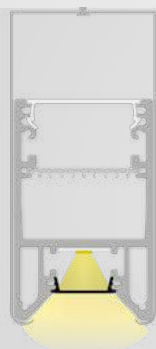

PN27 + C29 + C42 + Z64

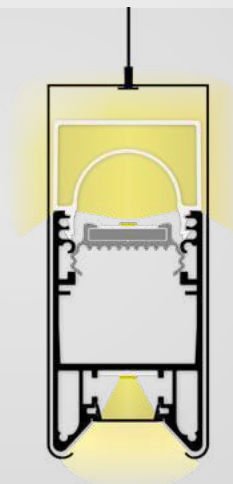

PN27 + C68 + C42 + Z65

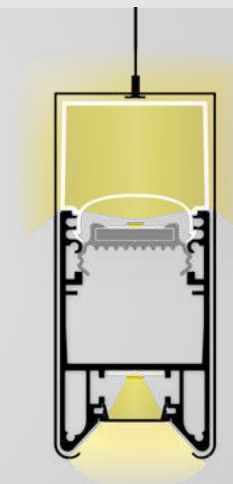

PN27 + C63 + C42 + Z65

max.
12 mm

max.
30 mm

OEM



COVERS | ABDECKUNGEN

C29 65 %	200cm 8600059	300cm 8123557
C61 80 %	200cm 8123342	300cm 8506151
C63 65 %	200 cm 8123340	300 cm 8123341
C64 75 %	200 cm 8123374	
C68 65 %	200 cm 8123571	300 cm 8123572

END CAPS | ENDKAPPEN

E119 <small>C29 C61</small>	<small>E119</small> 8192308	<small>E119</small> 8192307	<small>E119</small> 8192306
E120 <small>C63</small>	<small>E120</small> 8192302	<small>E120</small> 8192301	<small>E120</small> 8192300
E121 <small>C68</small>	<small>E121</small> 8192305	<small>E121</small> 8192304	<small>E121</small> 8192303
E124 <small>C29 C61</small>	<small>E124</small> 8192311	<small>E124</small> 8192310	<small>E124</small> 8192309

PROFILE

PN27	clickable cooling strip klickbarer Kühlstreifen		
	<small>200 cm</small> 8192289	<small>200 cm</small> 8192288	<small>200 cm</small> 8192290
	<small>300 cm</small> 8192291	<small>300 cm</small> 8192293	<small>300 cm</small> 8192292
	slidable cooling strip schiebbaren Kühlstreifen		
	<small>200 cm</small> 8192295	<small>200 cm</small> 8192294	<small>200 cm</small> 8192296
	<small>300 cm</small> 8192297	<small>300 cm</small> 8192299	<small>300 cm</small> 8192298

	<small>Z50</small> 8123360		<small>Z53</small> 8123401
	<small>Z60</small> 8123568 8123566 8123567		<small>Z64</small> 8192338 8192340 8192339

	<small>Z65</small> 8192341	<small>Z65W</small> 8192343	<small>Z65B</small> 8192342
	<small>Z04</small> 8123372	<small>Z04W</small> 8123386	<small>Z04B</small> 8123387

max.
12 mm

max.
30 mm

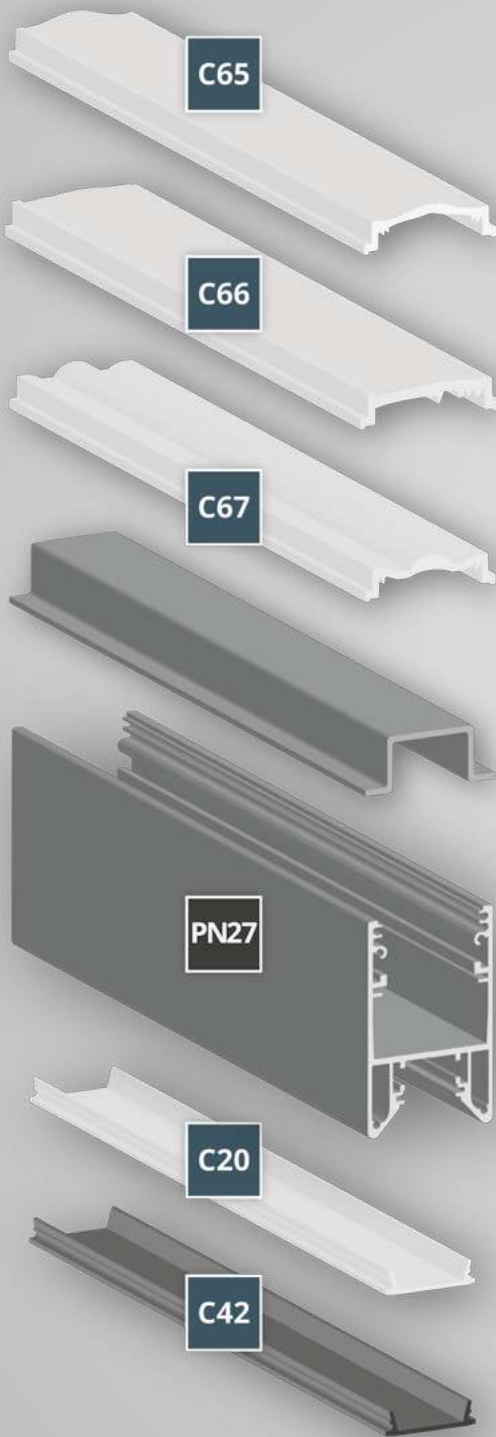

OEM

COVERS | ABDECKUNGEN

C65 80 % 117,6 cm
8123385

C66 80 % 117,6 cm
8123384

C67 80 % 117,6 cm
8123383

 Platform Cooling Strip
Podestkühlstreifen
117,6 cm **8123378**

for/für
C65, C66, C67

COVERS | ABDECKUNGEN

C20 65 % 200 cm 600 cm
8600048 8600049

C42 25 % 200 cm
8600092

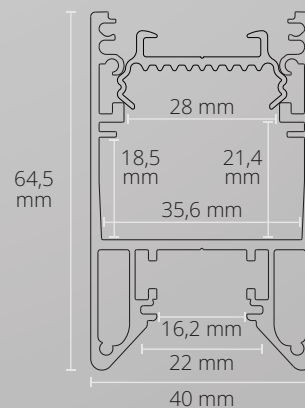



PN27 LUMINAIR | LEUCHTEN NEW

symmetrical | symmetrisch | LED Strips max. 12mm & 30 mm
40 mm x 64,5 mm

with clickable cooling strip / mit klickbarem Kühlstreifen: 136 g/m

- 200 cm 8192289
- 300 cm 8192291
- 200 cm 8192288
- 300 cm 8192293
- 200 cm 8192290
- 300 cm 8192292

with slidable cooling strip / mit schiebbarem Kühlstreifen: 195 g/m

- 200 cm 8192295
- 300 cm 8192297
- 200 cm 8192294
- 300 cm 8192299
- 200 cm 8192296
- 300 cm 8192298

Z50
Connecting element
Verbindungselement
8123360



More P. 406 | Mehr S. 406

Z53
Connector | Verbinder
flexibel 180°- 45°
2PCS/STK
8123401



Z64 NEW
Mounting bracket | Montagebügel
2PCS/STK
8192338
8192340
8192339



Z60 NEW
Connector | Verbinder
90° corner welded | 90° Eck geschweißt | 120x120mm
8123420 8123419 8123418



COVERS | ABDECKUNGEN



C29 opal | opal | 65 %
PC | 33,2 mm x 8,5 mm
200cm 8600059 300cm 8123557

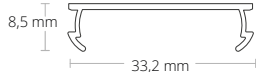

C61 opalplus | OpalPlus | 80 %
PC | 33,2 mm x 8,5 mm
200cm 8123342 300cm 8506151

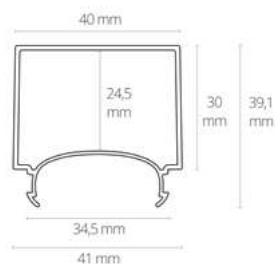

C63 opalplus | OpalPlus | 65%
PC | 40 mm x 39,1 mm
200cm 8123340 300cm 8123341

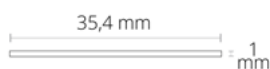

C64 prismatic | prismatisch | 75%
Slide-in cover | Einschubcover
200cm 8123374

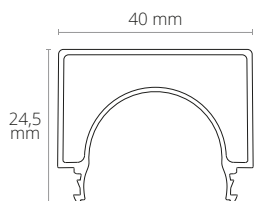

C68 opalplus | OpalPlus | 65% NEW
PC | 40 mm x 39,1 mm
200cm 8123340 300cm 8123341

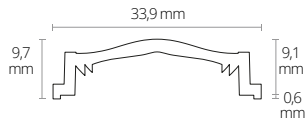

C65 double-asymmetrical | doppel-asymmetrisch
PMMA | 33,9 mm x 9,7 mm
117,6 cm
8123385

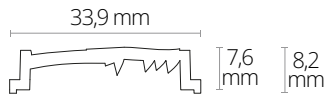

C66 asymmetrical | asymmetrisch
PMMA | 33,9 mm x 8,2 mm
117,6 cm
8123384

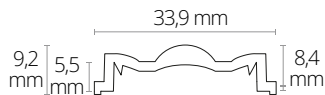

C67 asymmetrical | asymmetrisch | 60°
PMMA | 33,9 mm x 9,2 mm
117,6 cm
8123383



C20 opal | opal | 65 %
PC | 19,2 mm x 4,8 mm
200cm **8600048** 600cm **8600049**



C42 schwarz/matt | black/matt | 25 %
PC | 19,2 mm x 4,8 mm
200cm
8600092



Platform Cooling Strip
Podestkühlstreifen
for/für C65, C66, C67
117,6 cm **8123378**

END CAPS | ENDKAPPEN



E119 Plastic | Kunststoff | 2 PCS/STK
Light trap | Lichtfalle

E119 **8192308** E119 **8192307**

for C29/C61

NEW

E119 **8192306**



E120 Plastic | Kunststoff | 2 PCS/STK
Light trap | Lichtfalle

E120 **8192302** E120 **8192301**

for C63

NEW

E120 **8192300**



E121 Plastic | Kunststoff | 2 PCS/STK
Light trap | Lichtfalle

E121 **8192305** E121 **8192304**

for C68

NEW

E121 **8192303**



E124 Aluminium | 2 PCS/STK

E124 **8192311** E124 **8192310**

for C29/C61

NEW

E124 **8192309**

LINEAR LED PENDANT LAMP | LINEARE LED HÄNGELEUCHE



Z04 Hanging Wire System | Seilabhängung
Steel | Stahl | 3 m | Set | 75 kg

Z04 **8123372** Z04W **8123386** Z04B **8123387**



Z65 Hanging Wire System with mounting bracket |
Seilabhängung mit Montagebügel

Steel | Stahl | 1,5 m | Set | 75 kg

NEW

Z65 **8192341** Z65W **8192343** Z65B **8192342**



PN19V3

CORNER | ECK

200 cm

max. 20 mm

OEM



EXTENSION OF SERVICE LIFE
VERLÄNGERUNG LEBENSDAUER

MECHANICAL PROTECTION
MECHANISCHER SCHUTZ

COOLING
KÜHLUNG

HIGH LIGHT UTILISATION
HOHE LICHTVERWERTUNG

HOMOGENEOUS LIGHT
HOMOGENES LICHT

HOMOGENEOUS LIGHT with modular LED light solutions

- Wall or ceiling mounting
Wand- oder Deckenmontage
- Residential and office furniture
Wohn- und Büromöbel
- Furniture for business equipment
Möbel für Geschäftsausstattung
- Home accessories
Wohnaccessoires
- Mirrors | Spiegel
- Cabinet doors | Schranktüren
- Display cases | Vitrinen
- Shelves | Regale
- Stairs
Treppenstufen
- Balustrades | Balustraden
- Façades, balconies and terraces
Fassaden, Balkone und Terrassen
- Living spaces | Wohnräume
- Offices | Büroräume
- Hotel and gastronomy business
Hotellerie und Gastronomie
- Retail (shop and showcase windows)
Einzelhandel (Shop- und Schaufenster)
- Business areas and showrooms
Geschäftsflächen und Showrooms
- Barber / Beauty / body art studios
Friseur-/Beauty-/Body-Art-Studios
- Halls, foyers and corridors
Hallen, Foyers und Flure
- Wellness and indoor leisure facilities
Wellness- und Indoor-Freizeitanlagen
- Wet rooms | Nasszellen

Mounting/installation on/in wood Strips and plates, plasterboard, tiles, stone, granite, marble and metal surfaces
Montage/Einbau auf/in Holzleisten und -platten, Gipsplatten, Fliesen, Stein-, Granit-, Marmor- und Metalloberflächen

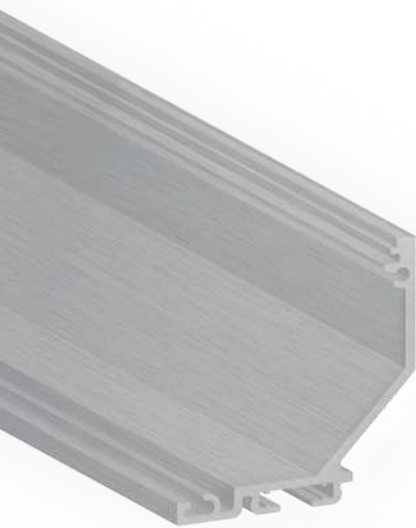

PN19V3

CORNER | ECK

LED Strips max. 20 mm

Silver/Silber
ANODIZED | ELOXIERT



max. 20 mm

max.
20 mm



OEM



PN19V3 LED CORNER profile is designed for LED flex-strips with a maximum width of 20 mm and is universally used in interior areas.

The angular-shaped and rounded LED profile cover opal/satinised (translucency 65 %) is made of shatter-proof, non-flammable polycarbonate (classification flammability UL94 V-2) and creates homogeneous LED lighting conditions with high utilisation of the light output. The interior height (distance between LED chips and cover) is coordinated for a continuous light line - no pinpoints of light!

The PN19V3 LED CORNER profile is the ideal light source for a general LED spatial and object illumination on walls and ceilings. The well-thought-out design is of special value. The profile is shaped asymmetrically. The corresponding cover gives a homogeneous spatial/object lighting in two directions. This profile system is ideal for mounting in corners.

This LED CORNER profile can be also equipped with a cord suspension without further adaptation and used as stand-alone LED pendant lamp (or in conjunction with the PL10 cable duct).

Das PN19V3 LED ECK-Profil ist für LED Flexbänder mit einer maximalen Breite von 20 mm konzipiert und wird universell im Innenbereich eingesetzt.

Die eckförmige sowie die abgerundete LED Profilabdeckung Opal/satiniert (Lichtdurchlässigkeit 65 %) bestehen aus bruchsicherem und schwer brennbarem Polycarbonat (Klassifizierung Brennbarkeit UL94 V-2) und schaffen homogene LED Lichtverhältnisse mit hoher Verwertung der Lichtleistung. Die Innenhöhe (Abstand zwischen LED Chips und Abdeckung) ist für eine durchgängige Lichtlinie abgestimmt - keine Lichtpunkte!

Das PN19V3 LED ECK-Profil ist die ideale Lichtquelle für eine allgemeine LED Raum- und Objektbeleuchtung an Wänden und Decken. Der besondere Mehrwert ist das durchdachte Design. Das Profil ist asymmetrisch geformt. Mit der dazugehörigen Abdeckung erzielt man eine homogene Raum-/Objektbeleuchtung in zwei Richtungen. Dieses Profilsystem ist perfekt für die Montage in Ecken.

Dieses LED ECK-Profil kann zudem ohne weiterer Adaption (oder in Verbindung mit dem PL10 Kabelkanal) mit einer Seilabhängung versehen und als eigenständige LED Hängeleuchte eingesetzt werden.

GALAXY profiles
Perfect Light Lines



PN19V3 + C16

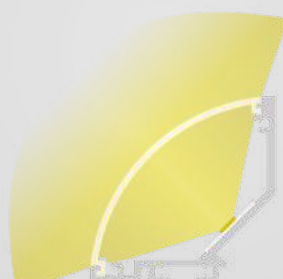

PN19V3 + C17

max.
20 mm

OEM



GALAXY profiles
Perfect Light Lines

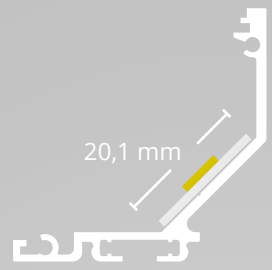

COVERS | ABDECKUNGEN

C16 65 % 200cm
8600023

C17 65 % 200cm
8600024

END CAPS | ENDKAPPEN

E52 E52
C16 8106075

E135 E135
C16 8123609

E55 E55
C17 8106077

PROFILE

PN19V3 200cm
8123359

Z10 8301504

Z11 8301505

Z50 8123360

Z53 8123401

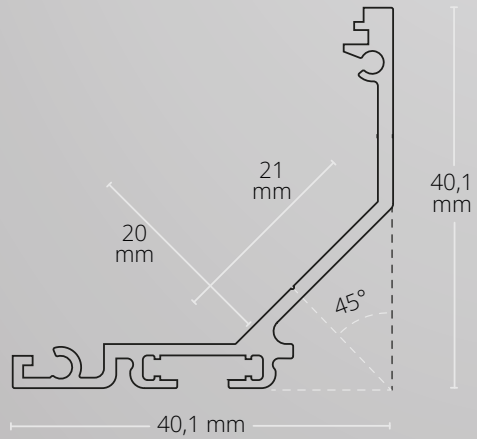

PN19V3 CORNER | ECK

LED Strips max. 20 mm
40,1 mm x 40,1 mm | 496 g/m

200 cm
8123359

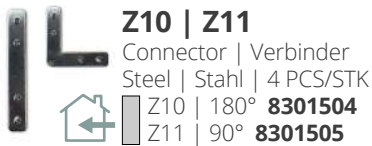

max.
20 mm

OEM



COVERS | ABDECKUNGEN

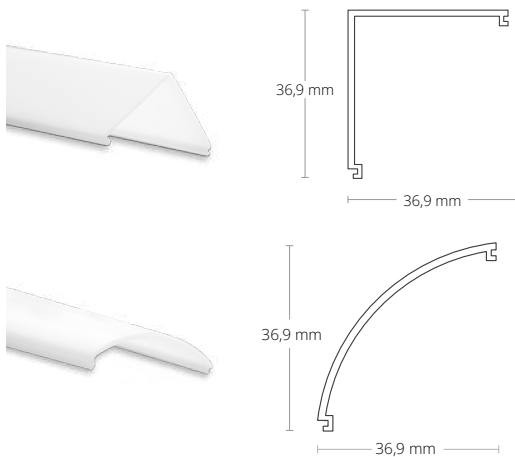

C16 opal | opal | 65 %
PC | 36,9 mm x 36,9 mm
200cm
8600023

C17 opal | opal | 65 %
PC | 36,9 mm x 36,9 mm
200cm
8600024

END CAPS | ENDKAPPEN

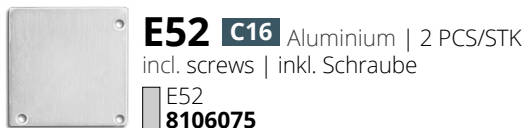

PN20V2

SURFACE | AUFBAU

200 cm

max. 20 mm

OEM

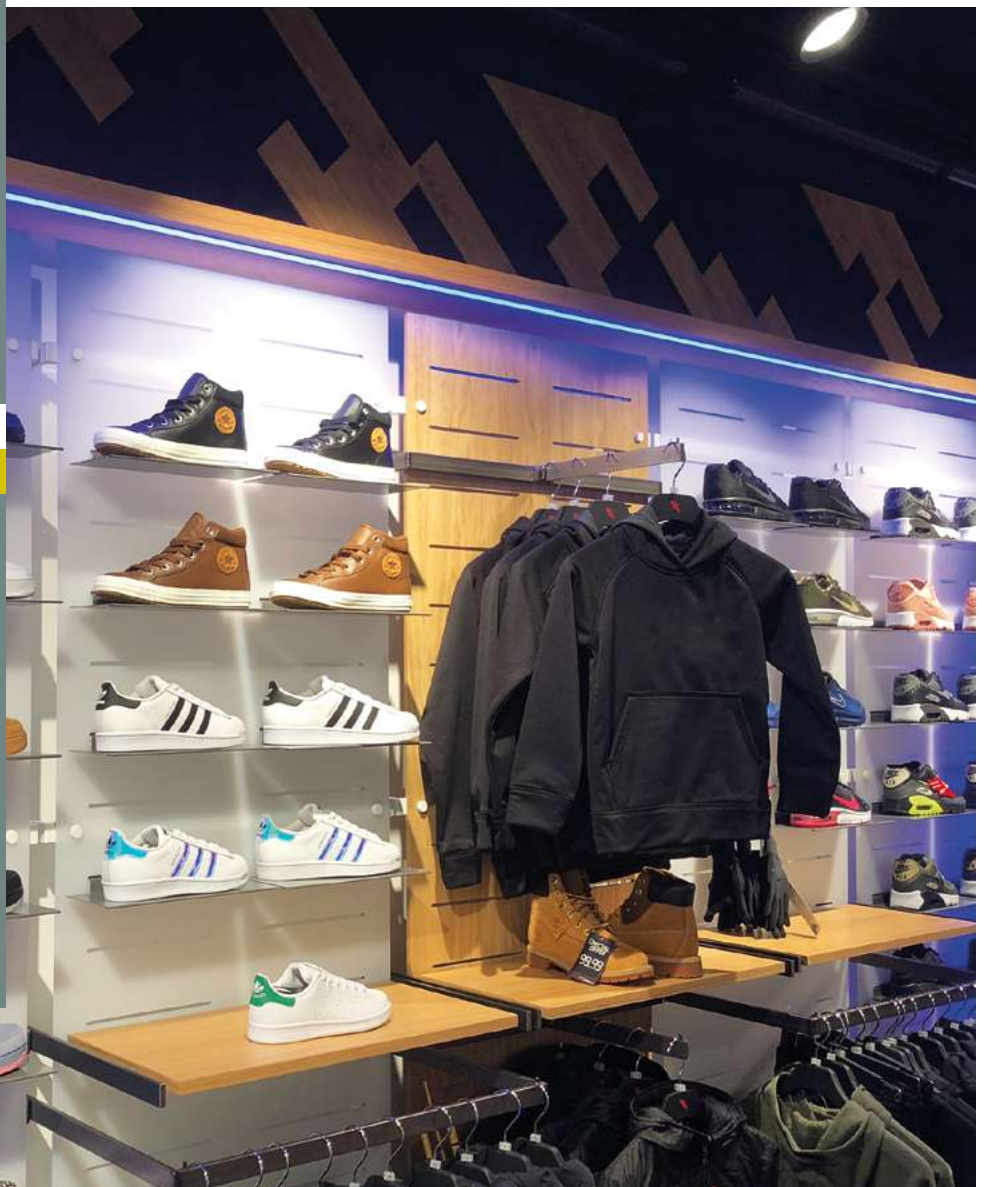

EXTENSION OF SERVICE LIFE
VERLÄNGERUNG LEBENSDAUER

MECHANICAL PROTECTION
MECHANISCHER SCHUTZ

COOLING
KÜHLUNG

HIGH LIGHT UTILISATION
HOHE LICHTVERWERTUNG

HOMOGENEOUS LIGHT
HOMOGENES LICHT

HOMOGENEOUS LIGHT with modular LED light solutions

- Homes
Wohnräume
- Offices, conference and presentation rooms
Büro-, Konferenz- und Präsentationsräume
- Waiting rooms
Ordinationen
- Business premises and sales floors
Geschäfts- und Verkaufsflächen
- Showrooms
- Hotel and gastronomy
Hotellerie und Gastronomie
- Foyers, corridors and connecting rooms
Foyers, Flure und Verbindungsräume
- Waiting and common rooms
Warte- und Aufenthaltsräume
- Commercial premises (e.g. hair salons)
Gewerbliche Dienstleistungsräumlichkeiten (z. B. Friseursalons etc.)
- Technology and supply rooms
Technik- und Versorgungsräume

Mounting/installation on/in wood Strips and plates, plasterboard, tiles, stone, granite, marble and metal surfaces
Montage/Einbau auf/in Holzleisten und -platten, Gipsplatten, Fliesen, Stein-, Granit-, Marmor- und Metalloberflächen



PN20V2

SURFACE | AUFBAU

high | hoch | LED Strips max. 20 mm

Silver/Silber
ANODIZED | ELOXIERT



max. 20 mm

max.
20 mm



OEM



The PN20 V2 LED SURFACE profile is supplied as standard in a length of 200 cm, is made of high-quality aluminium (anodised) and designed for use both as a SURFACE and RECESSED profile, as well as a standalone linear lighting system (in conjunction with the cable lock PL10 or the mounting profile PL10.1 - with and without wire suspension).

With the flat standard profile cover made of shatter-proof and flame-retardant polycarbonate (UL94 V-2 flammability classification - opal/satin finish - 65 % light transmission), the ALU profile is completely covered on the top side. LED stripes with a max. width of 20 mm can be glued in.

The PN20 V2 LED SURFACE profile has a very low internal height of only 8.6 mm. The cover is also available in 6 m!

Das PN20 V2 LED AUFBAU-Profil wird standardmäßig in der Länge 200 cm geliefert, ist aus hochwertigem Aluminium (eloxiert) gefertigt und für den Einsatz sowohl als AUFBAU- und EINBAU-Profil als auch als eigenständiges lineares Leuchtensystem (in Verbindung mit der Kabelschleuse PL10 oder dem Montageprofil PL10.1 mit und ohne Seilabhängung) konzipiert.

Mit der flachen Standard-Profilabdeckung aus bruchstärkerem und schwer brennbarem Polycarbonat (Klassifizierung Brennbarkeit UL94 V-2 - opal/satiniert - Lichtdurchlässigkeit 65 %) wird das ALU-Profil oberseitig komplett abgedeckt. Es können LED Flexbänder mit einer max. Breite von 20 mm eingeklebt werden.

Das PN20 V2 LED AUFBAU-Profil hat eine sehr geringe Innenhöhe von nur 8,6 mm. Die Abdeckung ist auch in 6 m verfügbar!

GALAXY profiles
Perfect Light Lines

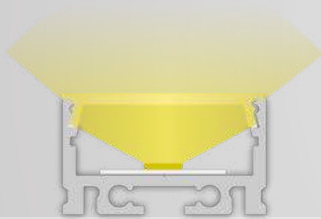

PN20V2 + C26

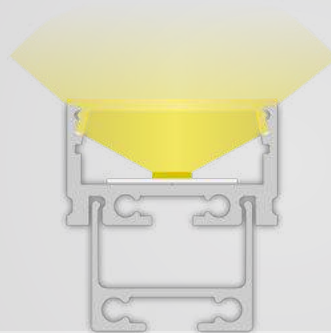

PN20V2 + PL10 + C26



PN20V2 + C26

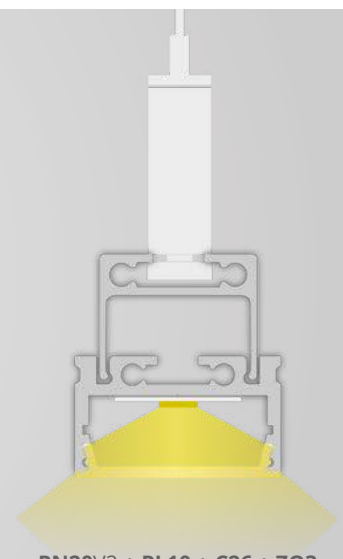

PN20V2 + PL10 + C26 + ZO3

175

- max. 20 mm
-
-
-
- OEM
-

GALAXY profiles
Perfect Light Lines

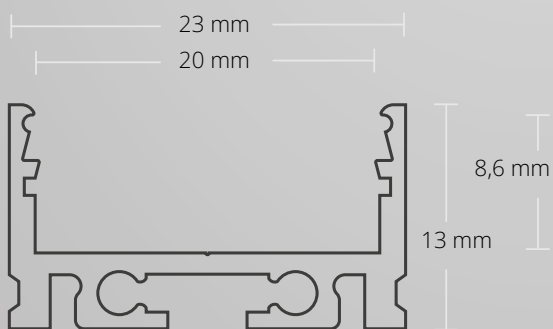
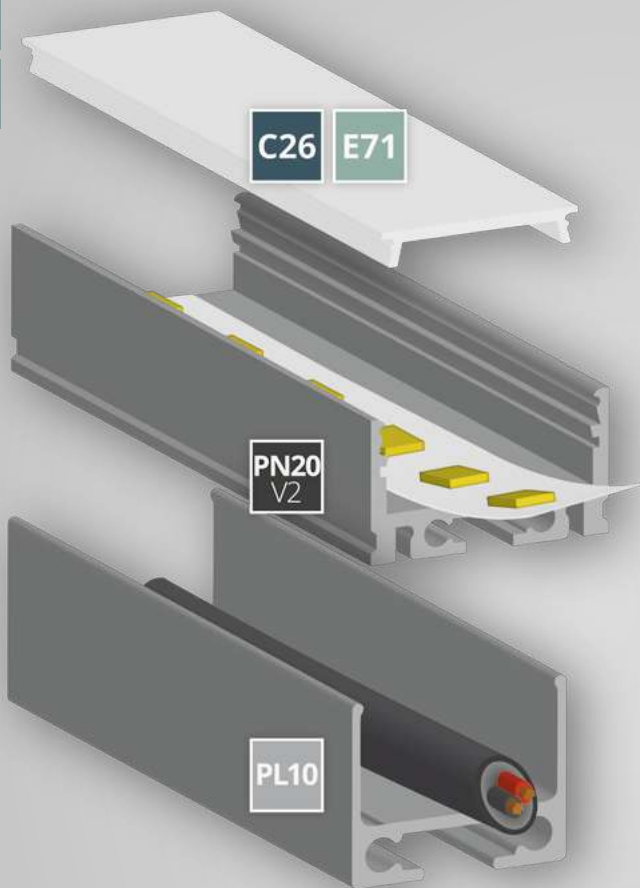
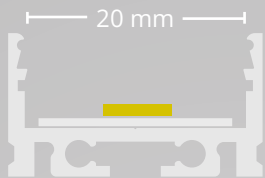

COVERS | ABDECKUNGEN

C26 65% 200cm 8600111 600cm 8600112

END CAPS | ENDKAPPEN

E71 E71 8102012

PROFILE

PN20 V2 200 cm 8102210

Z21 8102015

PL10.1
10 cm 8101085
200 cm 8101080

Z49 8301520

Z48 8301519

LINEAR LED PENDANT LAMP | LINEARE LED HÄNGELEUCHTE

PL10 200cm 8107012

Z10 8301504

Z11 8301505

Z03 8301502

Z05 8301501

PN20V2 SURFACE | AUFBAU

high | hoch | LED Strips max. 20 mm
23 mm x 13 mm | 210 g/m

200 cm
8102210

Z21
Mounting Clips
Montageklammer
Sheet steel | Stahlblech
8102015

PL10.1
Mounting Profile
Montageprofil
10 cm **8101085**
200 cm **8101080**

Z48 | Z49
Connector | Verbinder
Steel | Stahl | 4 PCS/STK
Z49 | 180° **8301520** Z48 | 90° **8301519**

max.
20 mm



CFM



COVERS | ABDECKUNGEN



C26 opal | opal | 65 %
PC | 23 mm x 3,9 mm
200cm **8600111** 600cm **8600112**

END CAPS | ENDKAPPEN



E71 Aluminium | 2 PCS/STK
incl. screws | inkl. Schraube

E71
8102012

LINEAR LED PENDANT LAMP | LINEARE LED HÄNGELEUCHE



PL10 universal duct | Universalkanal
for cable | für Kabel

200cm
8107012



Z10 | Z11 Connector | Verbinder
Steel | Stahl | 4 PCS/STK

Z10 | 180° **8301504** Z11 | 90° **8301505**



Z03 Hanging Wire System | Seilabhangung
Steel | Stahl | 1,5 m | Set | 75 kg

Z03
8301502



Z05 Gripper | Gelenkgripper
Steel | Stahl | 2 PCS/STK

Z05
8301501

PN21

RECESSED | EINBAU

200 cm

max. 20 mm

OEM



EXTENSION OF SERVICE LIFE
VERLÄNGERUNG LEBENSDAUER

MECHANICAL PROTECTION
MECHANISCHER SCHUTZ

COOLING
KÜHLUNG

HIGH LIGHT UTILISATION
HOHE LICHTVERWERTUNG

HOMOGENEOUS LIGHT
HOMOGENES LICHT

HOMOGENEOUS LIGHT with modular LED light solutions

- Homes
Wohnräume
- Offices, conference and presentation rooms
Büro-, Konferenz- und Präsentationsräume
- Waiting rooms
Ordinationen
- Business premises and sales floors
Geschäfts- und Verkaufsflächen
- Showrooms
- Hotel and gastronomy
Hotellerie und Gastronomie
- Foyers, corridors and connecting rooms
Foyers, Flure und Verbindungsräume
- Waiting and common rooms
Warte- und Aufenthaltsräume
- Commercial premises (e.g. hair salons)
Gewerbliche Dienstleistungsräumlichkeiten (z. B. Friseursalons etc.)
- Technology and supply rooms
Technik- und Versorgungsräume

Mounting/installation on/in wood Strips and plates, plasterboard, tiles, stone, granite, marble and metal surfaces
Montage/Einbau auf/in Holzleisten und -platten, Gipsplatten, Fliesen, Stein-, Granit-, Marmor- und Metalloberflächen



PN21

RECESSED | EINBAU

high/wings | hoch/Flügel | LED Strips max. 20 mm

Silver/Silber
ANODIZED | ELOXIERT



max. 20 mm

max.
20 mm



OEM



The PN21 LED RECESSED profile is supplied as standard in a length of 200 cm, is made of high-quality aluminium (anodised) and designed for use as an RECESSED profile (optionally with the additional PL10 or the mounting profile PL10.1).

With the flat standard profile cover made of shatter-proof and flame-retardant polycarbonate (UL94 V-2 flammability classification - opal/satin finish - 65 % light transmission), the ALU profile is completely covered on the top side. LED stripes with a max. width of 20 mm can be glued in.

The inside height of the PN21 is 15.1 mm. For this reason, even stronger LED strips can be used without one being aware of the individual points of light. The opal/satin finish produces a homogeneous light bar! The cover is also available in 6 m!

Das PN21 LED AUFBAU-Profil wird standardmäßig in der Länge 200 cm geliefert, ist aus hochwertigem Aluminium (eloxiert) gefertigt und für den Einsatz sowohl als AUFBAU- und EINBAU-Profil als auch als eigenständiges lineares Leuchtensystem (auch in Verbindung mit der Kabelschleuse PL10 oder dem Montageprofil PL10.1 – mit und ohne Seilabhängung) konzipiert.

Mit der flachen Standard-Profilabdeckung aus bruchstärkerem und schwer brennbarem Polycarbonat (Klassifizierung Brennbarkeit UL94 V-2 - opal/satiniert – Lichtdurchlässigkeit 65 %) wird das ALU-Profil oberseitig komplett abgedeckt. Es können LED Flexbänder mit einer max. Breite von 20 mm eingeklebt werden.

Die Innenhöhe des PN21 beträgt 15,1 mm. Aus diesem Grund können auch stärkere LED Strips verwendet werden, ohne dass man dabei die einzelnen Lichtpunkte wahrnimmt. Mit der opal/satinierten Abdeckung erhält man eine homogene Lichtleiste! Die Abdeckung ist auch in 6 m verfügbar!

GALAXY profiles
Perfect Light Lines

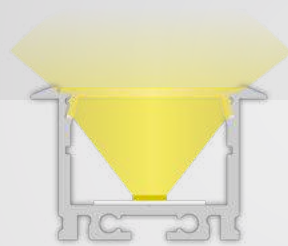

PN21 + C26

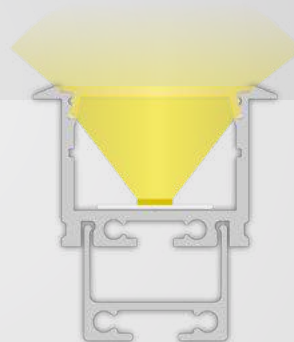

PN21 + PL10 + C26

max.
20 mm

OEM



GALAXY profiles
Perfect Light Lines

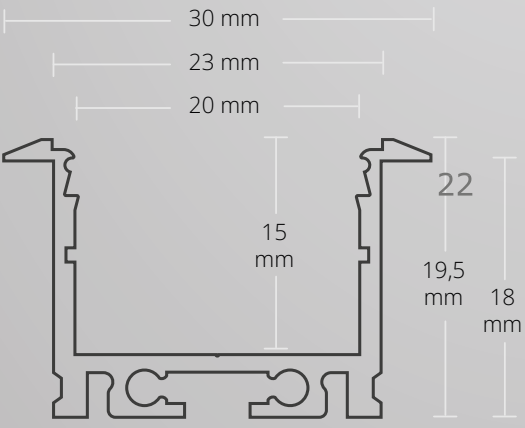
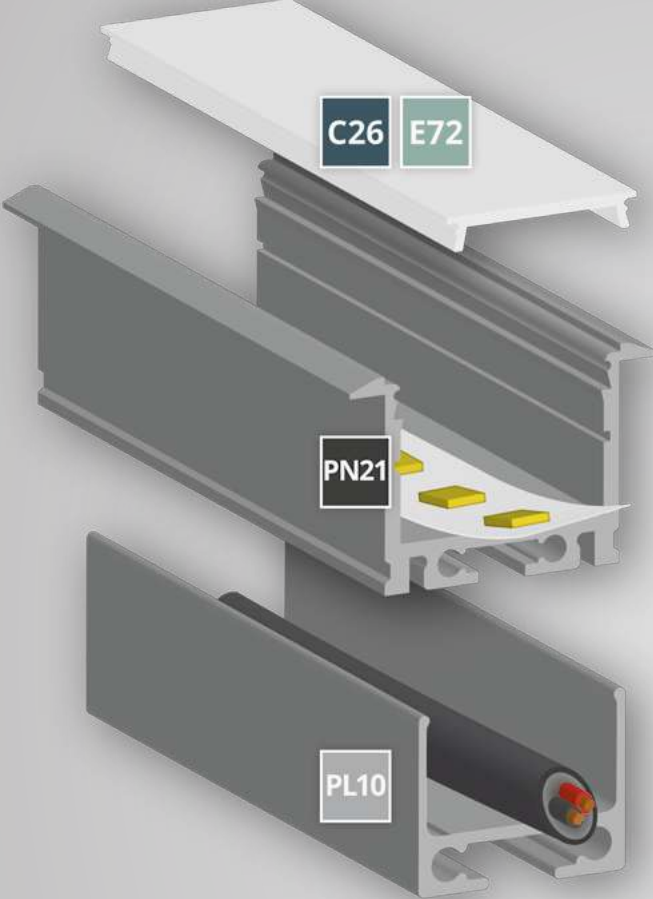
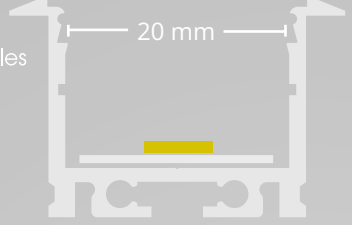

COVERS | ABDECKUNGEN

C26 65% 200cm 8600111 600cm 8600112

END CAPS | ENDKAPPEN

E72 E72 8102013

PROFILE

PN21 200 cm 8102211

Z21 8102015 PL10.1 10 cm 8101085 200 cm 8101080

Z49 8301520 Z48 8301519

Z44 8304038

LINEAR LED PENDANT LAMP | LINEARE LED HÄNGELEUCHE

PL10 200cm 8107012

Z10 8301504 Z11 8301505

PN21 RECESSED | EINBAU

high/wings | hoch/Flügel | LED Strips max. 20 mm
30 mm x 19,5 mm | 300 g/m

200 cm
8102211

**Z21**
Mounting Clips
Montageklammer
Sheet steel | Stahlblech
8102015

**PL10.1**
Mounting Profile
Montageprofil
10 cm **8101085**
200 cm **8101080**

**Z48 | Z49** Connector | Verbinder
Steel | Stahl | 4 PCS/STK
Z49 | 180° **8301520** Z48 | 90° **8301519**

**Z44** Spring-Gripper | Montagefeder
Stainless steel | Edelstahl
Z44 **8304038**

max.
20 mm



OEM



COVERS | ABDECKUNGEN



C26 opal | opal | 65 %
PC | 23 mm x 3,9 mm
200cm **8600111** 600cm **8600112**

END CAPS | ENDKAPPEN



E72 Aluminium | 2 PCS/STK
incl. screws | inkl. Schraube
E72 **8102013**

LINEAR LED PENDANT LAMP | LINEARE LED HÄNGELEUCHTE



PL10 universal duct | Universalkanal
for cable | für Kabel
200cm **8107012** 200cm **8107013** 200cm **8107014**

**Z10 | Z11** Connector | Verbinder
Steel | Stahl | 4 PCS/STK
Z10 | 180° **8301504** Z11 | 90° **8301505**

PN33

COOLING | KÜHLUNG

200 cm

max. 14 mm

OEM

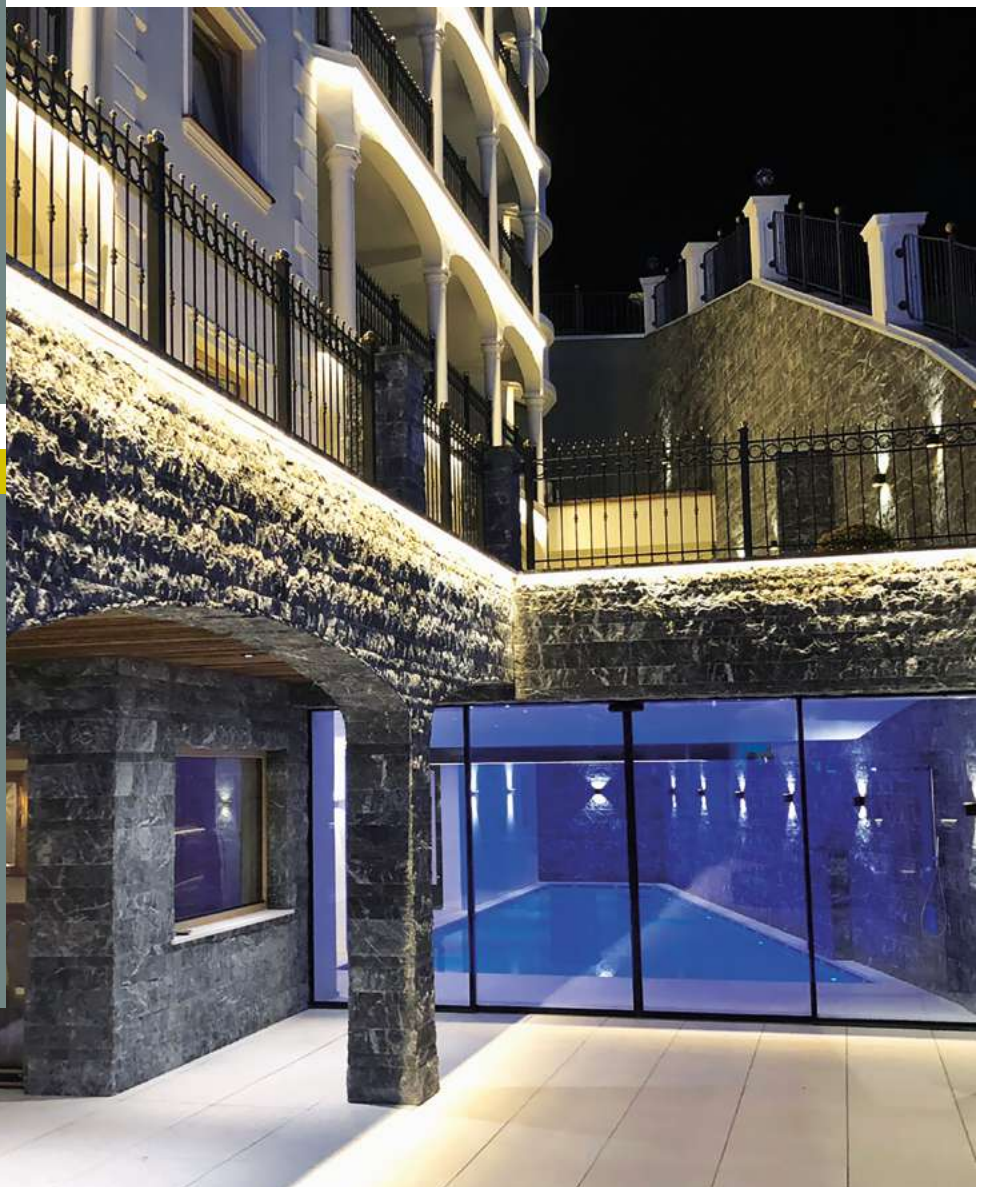

EXTENSION OF SERVICE LIFE
VERLÄNGERUNG LEBENSDAUER

MECHANICAL PROTECTION
MECHANISCHER SCHUTZ

COOLING
KÜHLUNG

HIGH LIGHT UTILISATION
HOHE LICHTVERWERTUNG

HOMOGENEOUS LIGHT
HOMOGENES LICHT

HOMOGENEOUS LIGHT with modular LED light solutions

- Wall, ceiling or floor mounting
Wand-, Decken- oder Bodenmontage
- Residential and office furniture
Wohn- und Büromöbel
- Furniture for business equipment
Möbel für Geschäftsausstattung
- Home accessories
Wohnaccessoires
- Mirrors | Spiegel
- Cabinet doors | Schranktüren
- Display cases | Vitrinen
- Shelves | Regale
- Balustrades | Balustraden
- Façades, balconies and terraces
Fassaden, Balkone und Terrassen
- Living spaces | Wohnräume
- Offices | Büroräume
- Hotel and gastronomy business
Hotellerie und Gastronomie
- Retail (shop and showcase windows)
Einzelhandel (Shop- und Schaufenster)
- Business areas and showrooms
Geschäftsflächen und Showrooms
- Barber / Beauty / body art studios
Friseur-/Beauty-/Body-Art-Studios
- Halls, foyers and corridors
Hallen, Foyers und Flure
- Wellness and indoor leisure facilities
Wellness- und Indoor-Freizeitanlagen
- Wet rooms | Nasszellen

Mounting/installation on/in wood Strips and plates, plasterboard, tiles, stone, granite, marble and metal surfaces
Montage/Einbau auf/in Holzleisten und -platten, Gipsplatten, Fliesen, Stein-, Granit-, Marmor- und Metalloberflächen



PN33

COOLING | KÜHLUNG

LED Strips max. 14 mm

Silver/Silber
ANODIZED | ELOXIERT



max. 14 mm

max.
14 mm

OEM



The PN33 cooling strip is designed for LED flexstrips with a maximum width of 15 mm which are placed centred along the groove and glued.

PN33 LED cooling strips by GALAXY® profiles are

- heat conducting.
- extend the life of the LED strips through this property and
- protect LED strips against mechanical influences.

LED cooling strips can be mounted on smooth surfaces with double-sided adhesive tape. Otherwise, they are fixed with screws on the structure.

Der PN33 Kühlstreifen ist für LED Flexbänder mit einer maximalen Breite von 14 mm konzipiert, die entlang der Nut mittig eingeklebt werden.

PN33 LED Kühlstreifen von GALAXY® profiles sind

- wärmeableitend,
- verlängern mit dieser Eigenschaft die Lebensdauer der LED Strips und
- schützen LED Strips vor mechanischen Einwirkungen.

LED Kühlstreifen können bei glatten Oberflächen auch mit einem beidseitigen Klebeband angebracht werden. Andernfalls werden sie mit Schrauben an der Substanz fixiert.

GALAXY profiles
Perfect Light Lines



PN33



PN33 + PO14

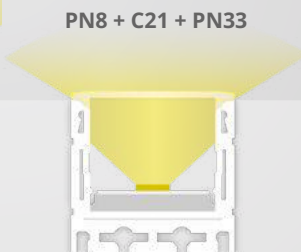

PN8 + C21 + PN33

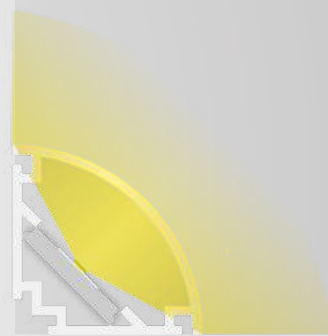

PN10 + PN33

max.
14 mm

GALAXY profiles
Perfect Light Lines

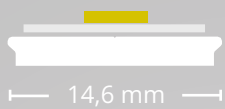

OEM



LED COOLING PROFILE | LED KÜHLSTREIFEN

PN33  200 cm
8105050

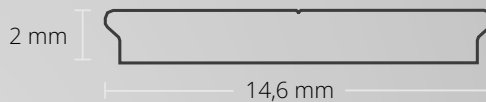
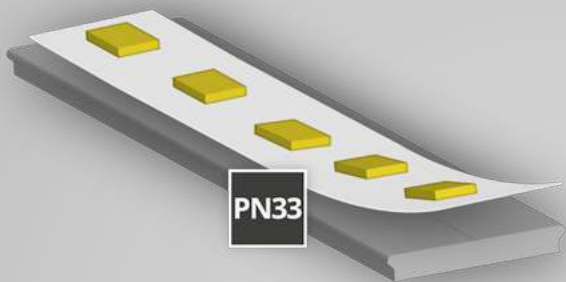

PN33 COOLING | KÜHLUNG

LED Strips max. 14 mm
14,6 mm x 2,0 mm | 77 g/m

200 cm
8105050

max.
14 mm

OEM



FP1

TILE | FLIESEN

200 cm | 250 cm | 300 cm

max. 12 mm

OEM

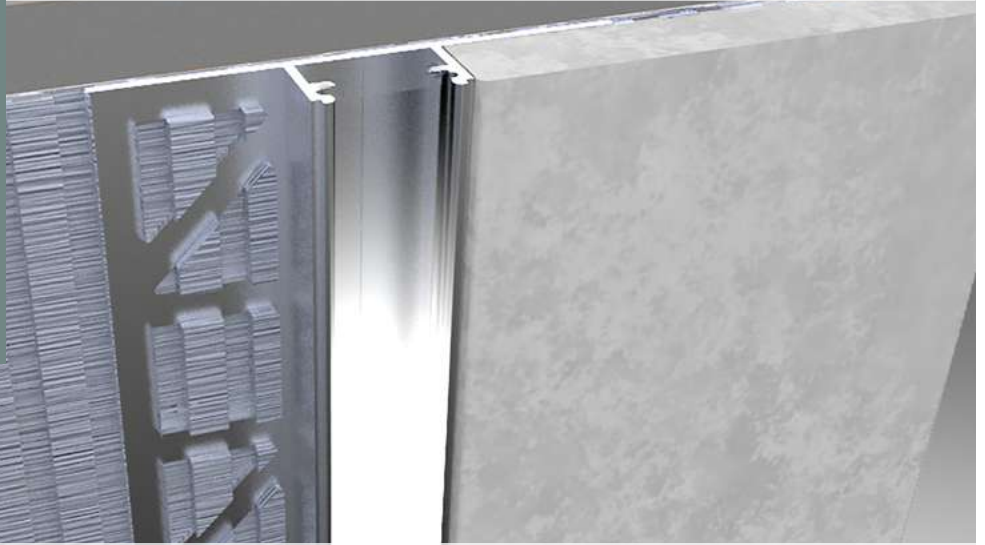

EXTENSION OF SERVICE LIFE
VERLÄNGERUNG LEBENSDAUER

MECHANICAL PROTECTION
MECHANISCHER SCHUTZ

COOLING
KÜHLUNG

HIGH LIGHT UTILISATION
HOHE LICHTVERWERTUNG

HOMOGENEOUS LIGHT
HOMOGENES LICHT

HOMOGENEOUS LIGHT with modular LED light solutions

- Bathrooms/WCs
Bad/WC
- Kitchens
Küche
- Utility rooms/cellars
Waschküche/Keller
- Technology rooms
Technikräume
- Spa and wellness areas
SPA- und Wellnessbereiche
- Swimming pools
Schwimm-/Hallenbäder
- Car washes
Autowaschanlagen/-waschstraßen
- Basically in any tile concept
Grundsätzlich in jedes Fliesenkonzept

Mounting/installation on/in wood Strips and plates, plasterboard, tiles, stone, granite, marble and metal surfaces

Montage/Einbau auf/in Holzleisten und -platten, Gipsplatten, Fliesen, Stein-, Granit-, Marmor- und Metalloberflächen

INSTALLATION INSTRUCTION INSTALLATIONS MONTAGE





FP1

TILE | FLIESEN

Middle | Mitte | LED Strips max. 12 mm

Silver/Silber
ANODIZED | ELOXIERT



max. 12 mm

max.
12 mm

OEM



Designed for tile concepts!

This MIDDLE FP1 LED TILE profile is available in the standard lengths of 200 cm, 250 cm and 300 cm, and is designed for LED stripes with a maximum width of 12 mm. This profile system has a large-area wings on both sides (20 mm wide), which are filled in with tile adhesive, thus integrating them into the tile concept. The tiles are glued on the wings. Due to its large surface, the FP1 LED TILE profile dissipates the heat generated very well.

These LED opal/satinised (65 % translucency), clear (85 % translucency), white/matt (translucency 75 %) or black matt (25 % translucency) are made of shatter-proof and flame-retardant polycarbonate (classification flammability UL94V-2), are flush-mounted and create homogeneous LED lighting conditions with high utilisation of the light output.

Important information:

The use in wet cells or outdoors is possible only in sealed form. Special protection against moisture and water is provided by silicone, which is applied to the joints for sealing purposes. Absolute watertightness is achieved for the LED profile systems by casting with Wepuran casting resin on polyurethane resin-basis (PUR).

When selecting the LED flex band, make sure that the protection class specified by the manufacturer (at least IP65) is maintained.

Design für Fliesenkonzepte!

Dieses FP1 LED FLIESEN-Profil MITTE ist in den Standardlängen von 200 cm, 250 cm und 300 cm erhältlich und ist für LED Flexbänder mit einer maximalen Breite von 12 mm konzipiert. Dieses Profilsystem hat beidseitig großflächige Flügel (20 mm breit), die mit Fliesenkleber verspachtelt und damit ins Fliesenkonzept integriert werden. Die Fliesen werden auf die Flügel geklebt. Das FP1 LED FLIESEN-Profil leitet aufgrund seiner großen Oberfläche die entstehende Wärme sehr gut ab.

Die LED Profilabdeckungen opal/satiniert (Lichtdurchlässigkeit 65 %), klar (Lichtdurchlässigkeit 85 %), weiß/matt (Lichtdurchlässigkeit 75 %) oder schwarz matt (Lichtdurchlässigkeit 25 %) bestehen aus bruchsicherem und schwer brennbarem Polycarbonat (Klassifizierung Brennbarkeit UL94V-2), schließen bündig ab und schaffen homogene LED Lichtverhältnisse mit hoher Verwertung der Lichtleistung.

Wichtiger Hinweis:

Der Einsatz in Nasszellen oder im Außenbereich ist ausschließlich nur in abgedichteter Form möglich. Besonderen Schutz vor Feuchtigkeit und Wasser bietet Silikon, das zum Abdichten auf die Verbindungsstellen aufgetragen wird. Absolute Wasserdichtheit erreicht man bei den LED Profilsystemen mit dem Vergießen mit Wepuran-Gießharz auf Polyurethanharzbasis (PUR).

Achten Sie bei der Wahl des LED Strips auf die herstellerseitig angegebene Schutzart (mindestens IP65).

GALAXY profiles
Perfect Light Lines

FP1 + C1

max.
12 mm

OEM



GALAXY profiles
Perfect Light Lines

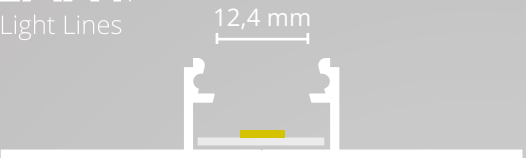

COVERS | ABDECKUNGEN

C1 65 %	200cm 8600004	250 cm 8600026	300 cm 8600080	600 cm 8600037
C2 85 %	200 cm 8600003	250 cm 8600135	300 cm 8600136	
C58 75 %	200 cm 8600154			
C32 25 %	200 cm 8600070	300 cm 8600103	600 cm 8600071	

END CAPS | ENDKAPPEN

E200	E200 81023001	E201	E201 81023002
-------------	------------------	-------------	------------------

PROTECTIVE COVER | SCHUTZCOVER

C1S	500 cm 8600065
------------	-------------------

PROFILE

FP1	200 cm 8102032
	250 cm 8102033
	300 cm 8102132

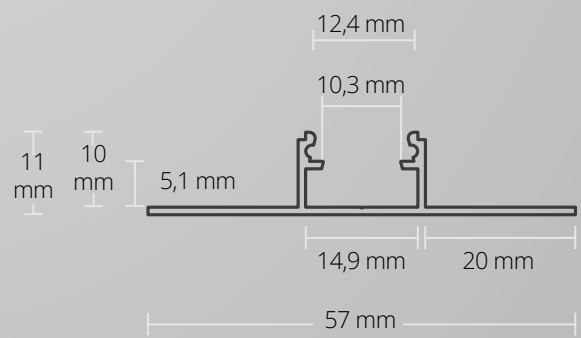

FP1 TILE | FLIESEN

Middle | Mitte | LED Strips max. 12 mm
57 mm x 11 mm | 150 g/m

200 cm **8102032** 250 cm **8102033** 300 cm **8102132**

max.
12 mm

OEM



COVERS | ABDECKUNGEN



C1 opal | opal | 65 %

PC | 13,8 mm x 4,4 mm

200cm **8600004** 250cm **8600026** 300cm **8600080** 600cm **8600037**

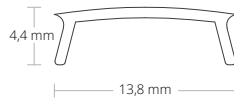

C2 clear | klar | 85 %

PC | 13,8 mm x 4,4 mm

200cm **8600003** 250cm **8600135** 300cm **8600136**



C58 white/matt | weiß/matt | 75 %

PC | 13,8 mm x 4,4 mm

200cm **8600154**



C32 black/matt | schwarz/matt | 25 %

PC | 13,8 mm x 4,4 mm

200cm **8600070** 300cm **8600103** 600cm **8600071**

END CAPS | ENDKAPPEN



E200 PVC | 1 PCS/STK

E200 **81023001**



E201 PVC | 1 PCS/STK | Cable/Kabel

E201 **81023002**

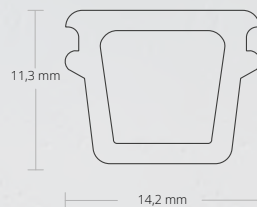

C1S Protective cover | Schutzcover

14,2 mm x 11,3 mm

500 cm **8600065**

The protective covers C1S and C10S soft are clicked into the aluminium profile for protection after the installation of drywall and tile profiles. The high-quality soft PVC is very robust and withstands the pressure of filling/plastering or painting. The protective cover prevents putty, glue, sealing material, silicone or paint from penetrating into the interior. Then the protective cover is removed, cleaned and is reusable several times over. Finally, the cover (PC) can be inserted into the profile.

Die Schutzcover C1S und C10S soft werden nach der Montage von Trockenbau- und Fliesenprofilen in das Alu-Profil zum Schutz eingeklickt. Das hochwertige Soft-PVC ist sehr robust und hält dem Druck beim Verspachteln/-putzen oder Streichen stand. Das Schutzcover verhindert, dass Spachtelmasse, Kleber, Dichtmaterial, Silikon oder Farbe in den Innenraum eindringt. Danach wird das Schutzcover abgenommen, gereinigt und ist vielfach wiederverwendbar. Abschließend kann die Abdeckung (PC) in das Profil eingesetzt werden.



FP2

TILE | FLIESEN

200 cm | 250 cm | 300 cm

max. 12 mm

OEM

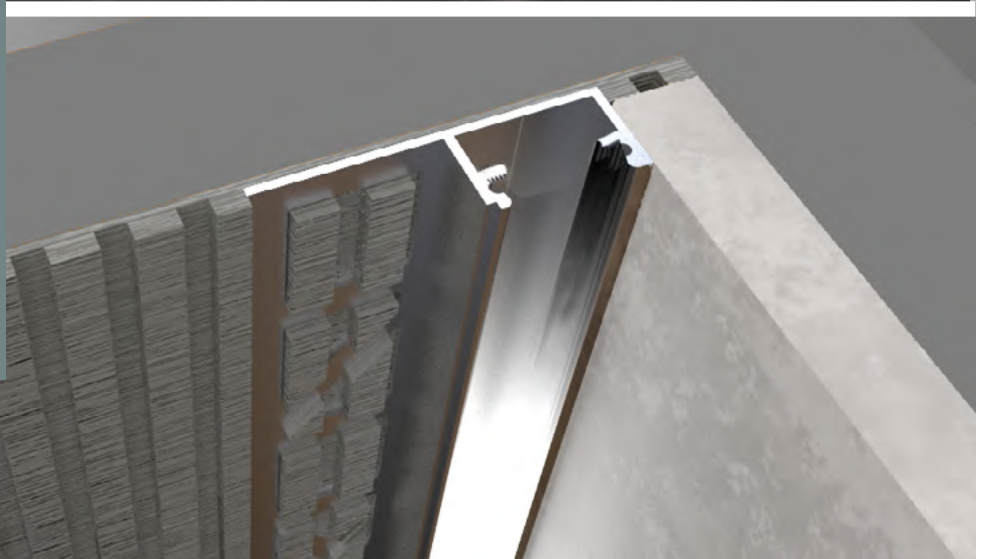

EXTENSION OF SERVICE LIFE
VERLÄNGERUNG LEBENSDAUER

MECHANICAL PROTECTION
MECHANISCHER SCHUTZ

COOLING
KÜHLUNG

HIGH LIGHT UTILISATION
HOHE LICHTVERWERTUNG

HOMOGENEOUS LIGHT
HOMOGENES LICHT

HOMOGENEOUS LIGHT with modular LED light solutions

- Bathrooms/WCs
Bad/WC
- Kitchens
Küche
- Utility rooms/cellars
Waschküche/Keller
- Technology rooms
Technikräume
- Spa and wellness areas
SPA- und Wellnessbereiche
- Swimming pools
Schwimm-/Hallenbäder
- Car washes
Autowaschanlagen/-waschstraßen
- Basically in any tile concept
Grundsätzlich in jedes Fliesenkonzept

Mounting/installation on/in wood Strips and plates, plasterboard, tiles, stone, granite, marble and metal surfaces
Montage/Einbau auf/in Holzleisten und -platten, Gipsplatten, Fliesen, Stein-, Granit-, Marmor- und Metalloberflächen



INSTALLATION INSTRUCTION
INSTALLATIONS MONTAGE







FP2

TILE | FLIESEN

Edge | Abschluss | LED Strips max. 12 mm

Silver/Silber
ANODIZED | ELOXIERT



max. 12 mm

max.
12 mm

OEM



Designed for tile concepts!

This EDGING FP2 LED TILE profile is available in the standard lengths of 200 cm, 250 cm and 300 cm, and is designed for LED stripes with a maximum width of 12 mm. This profile system has a large-area wing on one side, which is filled in with tile adhesive, thus integrating the aluminium profile into the tile concept. The FP2 LED TILE profile forms the luminous and flush finish of a tile surface.

These LED opal/satinised (65 % translucency), clear (85 % translucency), white/matt (translucency 75 %) or black matt (25 % translucency) are made of shatter-proof and flame-retardant polycarbonate (classification flammability UL94V-2), are flush-mounted and create homogeneous LED lighting conditions with high utilisation of the light output.

Important information:

The use in wet cells or outdoors is possible only in sealed form. Special protection against moisture and water is provided by silicone, which is applied to the joints for sealing purposes. Absolute watertightness is achieved for the LED profile systems by casting with Wepuran casting resin on polyurethane resin-basis (PUR).

When selecting the LED flex band, make sure that the protection class specified by the manufacturer (at least IP65) is maintained.

Design für Fliesenkonzepte!

Dieses FP2 LED FLIESEN-Profil ABSCHLUSS ist in den Standardlängen von 200 cm, 250 cm und 300 cm erhältlich und ist für LED Flexbänder mit einer maximalen Breite von 12 mm konzipiert. Dieses Profilsystem hat einseitig einen großflächigen Flügel, den man mit Fliesenkleber verspachtelt und damit das Alu-Profil ins Fliesenkonzept integriert. Das FP2 LED FLIESEN-Profil bildet den leuchtenden und bündigen Abschluss einer Fliesenfläche.

Die LED Profilabdeckungen opal/satiniert (Lichtdurchlässigkeit 65 %), klar (Lichtdurchlässigkeit 85 %), weiß/matt (Lichtdurchlässigkeit 75 %) oder schwarz matt (Lichtdurchlässigkeit 25 %) bestehen aus bruchsicherem und schwer brennbarem Polycarbonat (Klassifizierung Brennbarkeit UL94V-2), schließen bündig ab und schaffen homogene LED Lichtverhältnisse mit hoher Verwertung der Lichtleistung.

Wichtiger Hinweis:

Der Einsatz in Nasszellen oder im Außenbereich ist ausschließlich nur in abgedichteter Form möglich. Besonderen Schutz vor Feuchtigkeit und Wasser bietet Silikon, das zum Abdichten auf die Verbindungsstellen aufgetragen wird. Absolute Wasserdichtheit erreicht man bei den LED Profilsystemen mit dem Vergießen mit Wepuran-Gießharz auf Polyurethanharzbasis (PUR).

Achten Sie bei der Wahl des LED Strips auf die herstellerseitig angegebene Schutzart (mindestens IP65).

GALAXY profiles
Perfect Light Lines

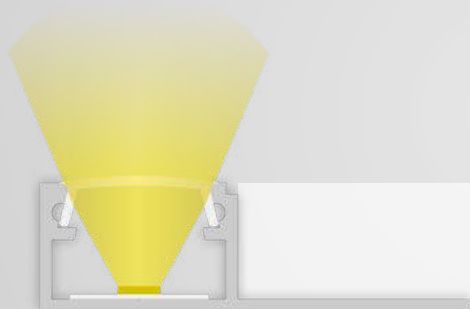

FP2 + C1

max.
12 mm

OEM



GALAXY profiles
Perfect Light Lines

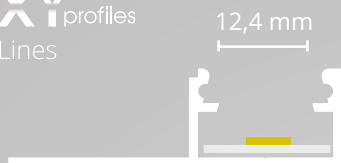

COVERS | ABDECKUNGEN

C1 65 %	200cm 8600004	250 cm 8600026	300 cm 8600080	600 cm 8600037
C2 85 %	200 cm 8600003	250 cm 8600135	300 cm 8600136	
C58 75 %	200 cm 8600154			
C32 25 %	200 cm 8600070	300 cm 8600103	600 cm 8600071	

END CAPS | ENDKAPPEN

E202	E202 81023003	E203	E203 81023004
-------------	------------------	-------------	------------------

PROTECTIVE COVER | SCHUTZCOVER

C1S	500 cm 8600065
------------	-------------------

PROFILE

FP2	200 cm 8102034
	250 cm 8102035
	300 cm 8102134

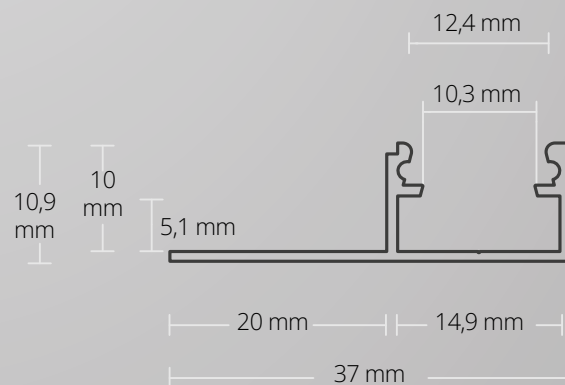

FP2 TILE | FLIESEN

Edge | Abschluss | LED Strips max. 12 mm

37 mm x 10,9 mm | 140 g/m

200 cm **8102034** 250 cm **8102035** 300 cm **8102134**

max.
12 mm

OEM



COVERS | ABDECKUNGEN



C1 opal | opal | 65 %

PC | 13,8 mm x 4,4 mm

200cm **8600004** 250cm **8600026** 300cm **8600080** 600cm **8600037**

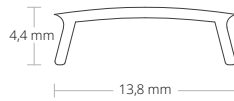

C2 clear | klar | 85 %

PC | 13,8 mm x 4,4 mm

200cm **8600003** 250cm **8600135** 300cm **8600136**



C58 white/matt | weiß/matt | 75 %

PC | 13,8 mm x 4,4 mm

200cm **8600154**



C32 black/matt | schwarz/matt | 25 %

PC | 13,8 mm x 4,4 mm

200cm **8600070** 300cm **8600103** 600cm **8600071**

END CAPS | ENDKAPPEN



E202 PVC | 1 PCS/STK

E202 **81023003**

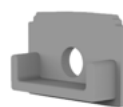

E203 PVC | 1 PCS/STK | Cable/Kabel

E203 **81023004**

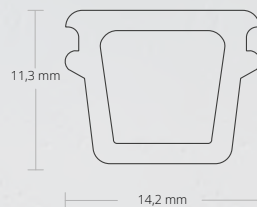

C1S Protective cover | Schutzcover

14,2 mm x 11,3 mm

500 cm **8600065**

The protective covers C1S and C10S soft are clicked into the aluminium profile for protection after the installation of drywall and tile profiles. The high-quality soft PVC is very robust and withstands the pressure of filling/plastering or painting. The protective cover prevents putty, glue, sealing material, silicone or paint from penetrating into the interior. Then the protective cover is removed, cleaned and is reusable several times over. Finally, the cover (PC) can be inserted into the profile.

Die Schutzcover C1S und C10S soft werden nach der Montage von Trockenbau- und Fliesenprofilen in das Alu-Profil zum Schutz eingeklickt. Das hochwertige Soft-PVC ist sehr robust und hält dem Druck beim Verspachteln/-putzen oder Streichen stand. Das Schutzcover verhindert, dass Spachtelmasse, Kleber, Dichtmaterial, Silikon oder Farbe in den Innenraum eindringt. Danach wird das Schutzcover abgenommen, gereinigt und ist vielfach wiederverwendbar. Abschließend kann die Abdeckung (PC) in das Profil eingesetzt werden.



FP3

TILE | FLIESEN

200 cm | 250 cm | 300 cm

max. 8 mm

OEM

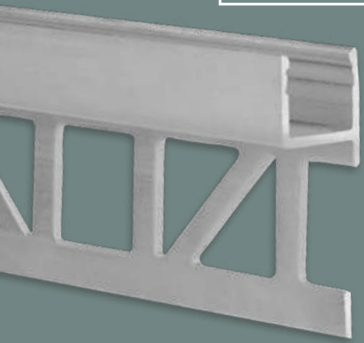

EXTENSION OF SERVICE LIFE
VERLÄNGERUNG LEBENSDAUER

MECHANICAL PROTECTION
MECHANISCHER SCHUTZ

COOLING
KÜHLUNG

HIGH LIGHT UTILISATION
HOHE LICHTVERWERTUNG

HOMOGENEOUS LIGHT
HOMOGENES LICHT

HOMOGENEOUS LIGHT with modular LED light solutions

- Bathrooms/WCs
Bad/WC
- Kitchens
Küche
- Utility rooms/cellars
Waschküche/Keller
- Technology rooms
Technikräume
- Spa and wellness areas
SPA- und Wellnessbereiche
- Swimming pools
Schwimm-/Hallenbäder
- Car washes
Autowaschanlagen/-waschstraßen
- Basically in any tile concept
Grundsätzlich in jedes Fliesenkonzept

Mounting/installation on/in wood Strips and plates, plasterboard, tiles, stone, granite, marble and metal surfaces
Montage/Einbau auf/in Holzleisten und -platten, Gipsplatten, Fliesen, Stein-, Granit-, Marmor- und Metalloberflächen



FP3

TILE | FLIESEN

Fliesenhöhe: 8 mm | Tile height: 8 mm | LED Strips max. 8 mm

 Silver/Silber
ANODIZED | ELOXIERT

 RAL 9003 White/Weiß
POWDER-COATED | PULVERBESCHICHTET



max. 8 mm

**max.
8 mm**

OEM



Designed for tile concepts!

This FP3 LED TILE profile is available in standard lengths of 200 cm, 250 cm and 300 cm and is designed for LED flex Strips with a maximum width of 8 mm. It can be used for a tile with the height of 8 mm. This profile system has a large-surface wing on one side that can be filled with tile adhesive, thus integrating the aluminium profile into the tile concept. The FP3 LED TILE profile forms the luminous and flush finish of a tiled surface.

The LED profile covers opal/satinised (65 % translucency) or black matt (25 % translucency) are made of shatter-proof and flame-retardant polycarbonate (classification flammability UL94V-2), are flush-mounted and create homogeneous LED lighting conditions with high utilisation of the light output.

Important information:

The use in wet cells or outdoors is possible only in sealed form. Special protection against moisture and water is provided by silicone, which is applied to the joints for sealing purposes. Absolute watertightness is achieved for the LED profile systems by casting with Wepuran casting resin on polyurethane resin-basis (PUR).

When selecting the LED flex band, make sure that the protection class specified by the manufacturer (at least IP65) is maintained.

Design für Fliesenkonzepte!

Dieses FP3 LED FLIESEN-Profil ist in den Standardlängen von 200 cm, 250 cm und 300 cm erhältlich und ist für LED Flexbänder mit einer maximalen Breite von 8 mm konzipiert. Es kann für eine Fliese mit der Höhe von 8 mm verwendet werden. Dieses Profilsystem hat einseitig einen großflächigen Flügel, den man mit Fliesenkleber verspachtelt und damit das Alu-Profil ins Fliesenkonzept integriert. Das FP3 LED FLIESEN-Profil bildet den leuchtenden und bündigen Abschluss einer Fliesenfläche.

Die LED Profilabdeckungen opal/satiniert (Lichtdurchlässigkeit 65 %) oder schwarz matt (Lichtdurchlässigkeit 25 %) bestehen aus bruchsicherem und schwer brennbarem Polycarbonat (Klassifizierung Brennbarkeit UL94V-2), schließen bündig ab und schaffen homogene LED Lichtverhältnisse mit hoher Verwertung der Lichtleistung.

Wichtiger Hinweis:

Der Einsatz in Nasszellen oder im Außenbereich ist ausschließlich nur in abgedichteter Form möglich. Besonderen Schutz vor Feuchtigkeit und Wasser bietet Silikon, das zum Abdichten auf die Verbindungsstellen aufgetragen wird. Absolute Wasserdichtheit erreicht man bei den LED Profilsystemen mit dem Vergießen mit Wepuran-Gießharz auf Polyurethanharzbasis (PUR).

Achten Sie bei der Wahl des LED Strips auf die herstellerseitig angegebene Schutzart (mindestens IP65).

GALAXY profiles
Perfect Light Lines

FP3 + C23

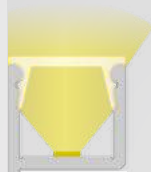

FP3 + C34



max.
8 mm

OEM



GALAXY profiles
Perfect Light Lines

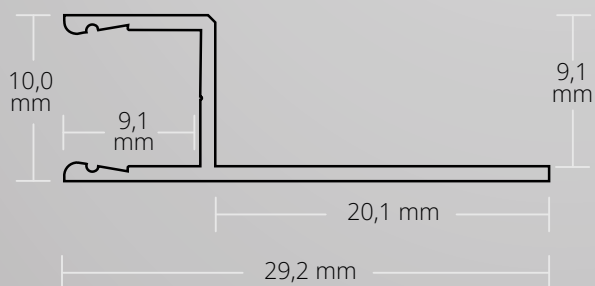
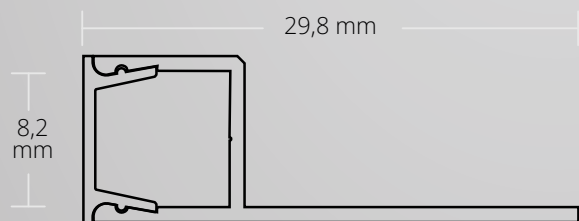
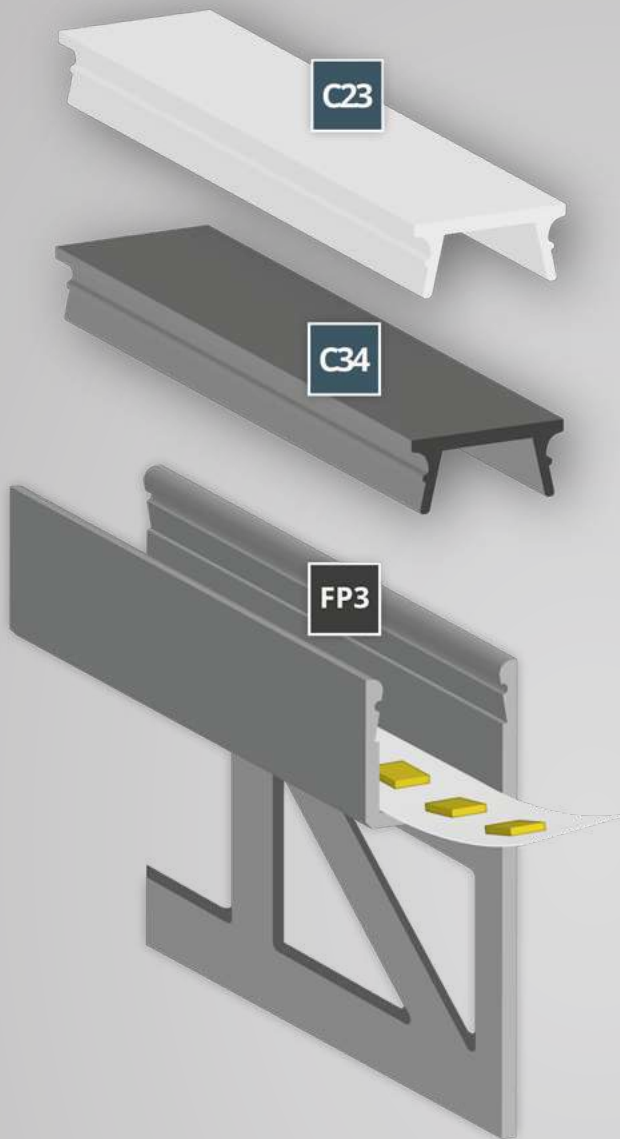

COVERS | ABDECKUNGEN

C23 65 % 200cm 8600046 300cm 8600116 600cm 8600047

C34 85 % 200cm 8600074 600cm 8600075

PROFILE

FP3 200 cm 8123174 200 cm 8123322
 250 cm 8123175
 300 cm 8123210

END CAPS | ENDKAPPEN

E218 E218 8102319 E218 8304022

E219 E219 8102320 E219 8304023



FP3 TILE | FLIESEN

Fliesenhöhe: 8 mm | Tile height: 8 mm | LED Strips max. 8 mm
10 mm x 29,2 mm | 86 g/m

- 200 cm 8123174
- 250 cm 8123175
- 300 cm 8123210
- 200 cm 8123322

max. 8 mm

OEM

COVERS | ABDECKUNGEN

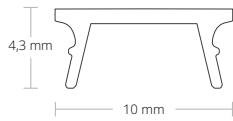

C23 opal | opal | 65 %
PC | 10,0 mm x 4,3 mm
200cm 300cm 600cm
8600046 8600116 8600047

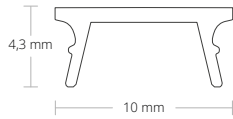

C34 black/matt | schwarz/matt | 25 %
PC | 10,0 mm x 4,3 mm
200cm 600cm
8600074 8600075

END CAPS | ENDKAPPEN



E218 PETG | 1 PCS/STK 
E218 8102319 E218 8304022



E219 PETG | 1 PCS/STK | Cable/Kabel 
E219 8102320 E219 8304023

FP4

TILE | FLIESEN

200 cm | 250 cm | 300 cm

max. 10 mm

OEM

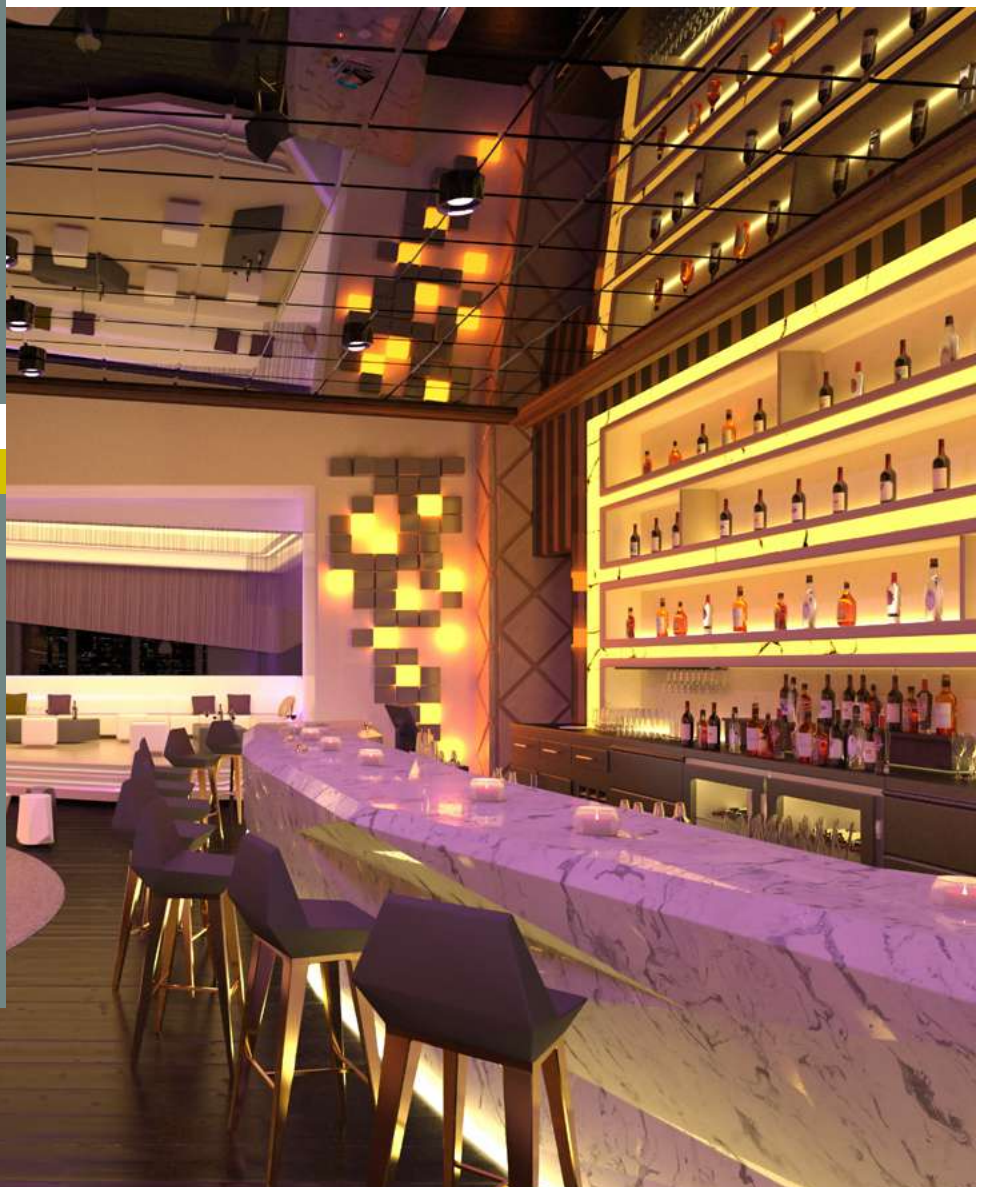

EXTENSION OF SERVICE LIFE
VERLÄNGERUNG LEBENSDAUER

MECHANICAL PROTECTION
MECHANISCHER SCHUTZ

COOLING
KÜHLUNG

HIGH LIGHT UTILISATION
HOHE LICHTVERWERTUNG

HOMOGENEOUS LIGHT
HOMOGENES LICHT

HOMOGENEOUS LIGHT with modular LED light solutions

- Bathrooms/WCs
Bad/WC
- Kitchens
Küche
- Utility rooms/cellars
Waschküche/Keller
- Technology rooms
Technikräume
- Spa and wellness areas
SPA- und Wellnessbereiche
- Swimming pools
Schwimm-/Hallenbäder
- Car washes
Autowaschanlagen/-waschstraßen
- Basically in any tile concept
Grundsätzlich in jedes Fliesenkonzept

Mounting/installation on/in wood Strips and plates, plasterboard, tiles, stone, granite, marble and metal surfaces
Montage/Einbau auf/in Holzleisten und -platten, Gipsplatten, Fliesen, Stein-, Granit-, Marmor- und Metalloberflächen



FP4

TILE | FLIESEN

Fliesenhöhe: 10 mm | Tile height: 10 mm | LED Strips max. 10 mm

 Silver/Silber
ANODIZED | ELOXIERT

 RAL 9003 White/Weiß
POWDER-COATED | PULVERBESCHICHTET



max. 10 mm



Designed for tile concepts!

This FP4 LED TILE profile is available in standard lengths of 200 cm, 250 cm and 300 cm and is designed for LED flex Strips with a maximum width of 10 mm. It can be used for a tile with the height of 10 mm. This profile system has a large-surface wing on one side that can be filled with tile adhesive, thus integrating the aluminium profile into the tile concept. The FP4 LED TILE profile forms the luminous and flush finish of a tiled surface.

The LED profile covers opal/satinised (65 % translucency) or black matt (25 % translucency) are made of shatter-proof and flame-retardant polycarbonate (classification flammability UL94V-2), are flush-mounted and create homogeneous LED lighting conditions with high utilisation of the light output.

Important information:

The use in wet cells or outdoors is possible only in sealed form. Special protection against moisture and water is provided by silicone, which is applied to the joints for sealing purposes. Absolute watertightness is achieved for the LED profile systems by casting with Wepuran casting resin on polyurethane resin-basis (PUR).

When selecting the LED flex band, make sure that the protection class specified by the manufacturer (at least IP65) is maintained.

Design für Fliesenkonzepte!

Dieses FP4 LED FLIESEN-Profil ist in den Standardlängen von 200 cm, 250 cm und 300 cm erhältlich und ist für LED Flexbänder mit einer maximalen Breite von 10 mm konzipiert. Es kann für eine Fliese mit der Höhe von 10 mm verwendet werden. Dieses Profilsystem hat einseitig einen großflächigen Flügel, den man mit Fliesenkleber verspachtelt und damit das Alu-Profil ins Fliesenkonzept integriert. Das FP4 LED FLIESEN-Profil bildet den leuchtenden und bündigen Abschluss einer Fliesenfläche.

Die LED Profilabdeckungen opal/satiniert (Lichtdurchlässigkeit 65 %) oder schwarz matt (Lichtdurchlässigkeit 25 %) bestehen aus bruchsicherem und schwer brennbarem Polycarbonat (Klassifizierung Brennbarkeit UL94V-2), schließen bündig ab und schaffen homogene LED Lichtverhältnisse mit hoher Verwertung der Lichtleistung.

Wichtiger Hinweis:

Der Einsatz in Nasszellen oder im Außenbereich ist ausschließlich nur in abgedichteter Form möglich. Besonderen Schutz vor Feuchtigkeit und Wasser bietet Silikon, das zum Abdichten auf die Verbindungsstellen aufgetragen wird. Absolute Wasserdichtheit erreicht man bei den LED Profilsystemen mit dem Vergießen mit Wepuran-Gießharz auf Polyurethanharzbasis (PUR).

Achten Sie bei der Wahl des LED Strips auf die herstellerseitig angegebene Schutzart (mindestens IP65).

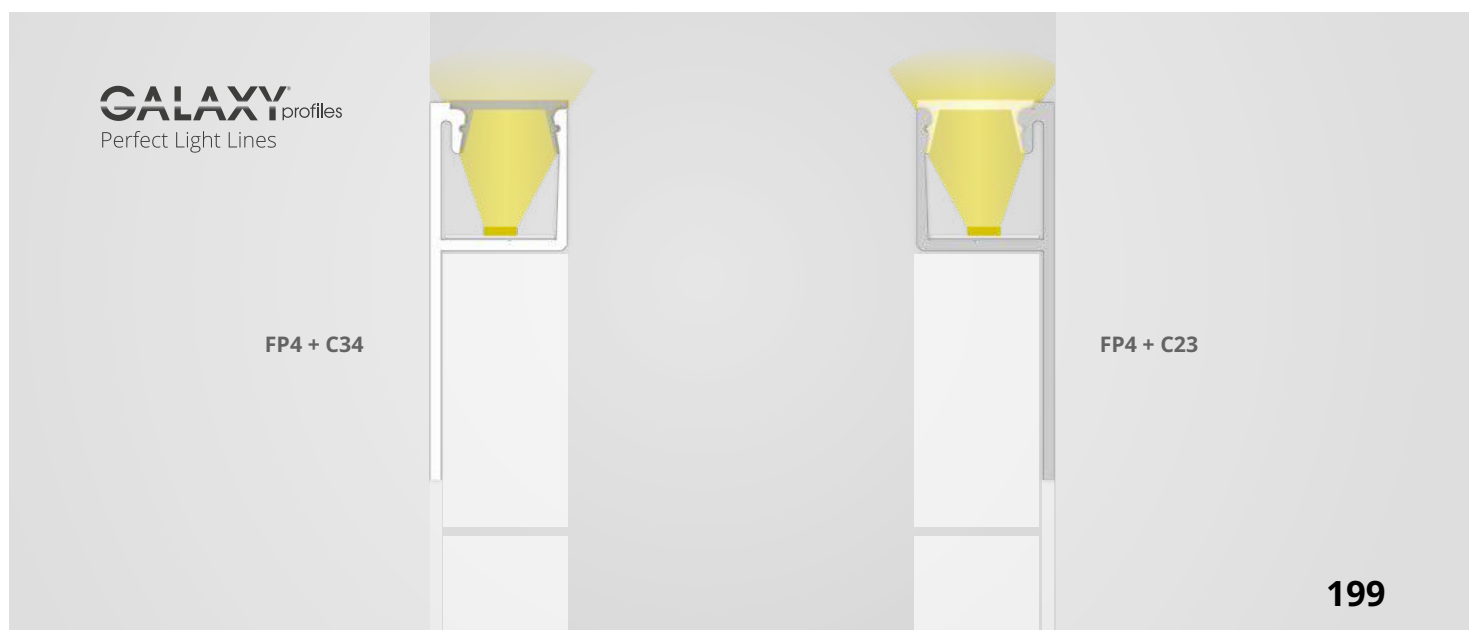

GALAXY profiles
Perfect Light Lines

FP4 + C34

FP4 + C23

max.
10 mm

OEM



GALAXY profiles
Perfect Light Lines

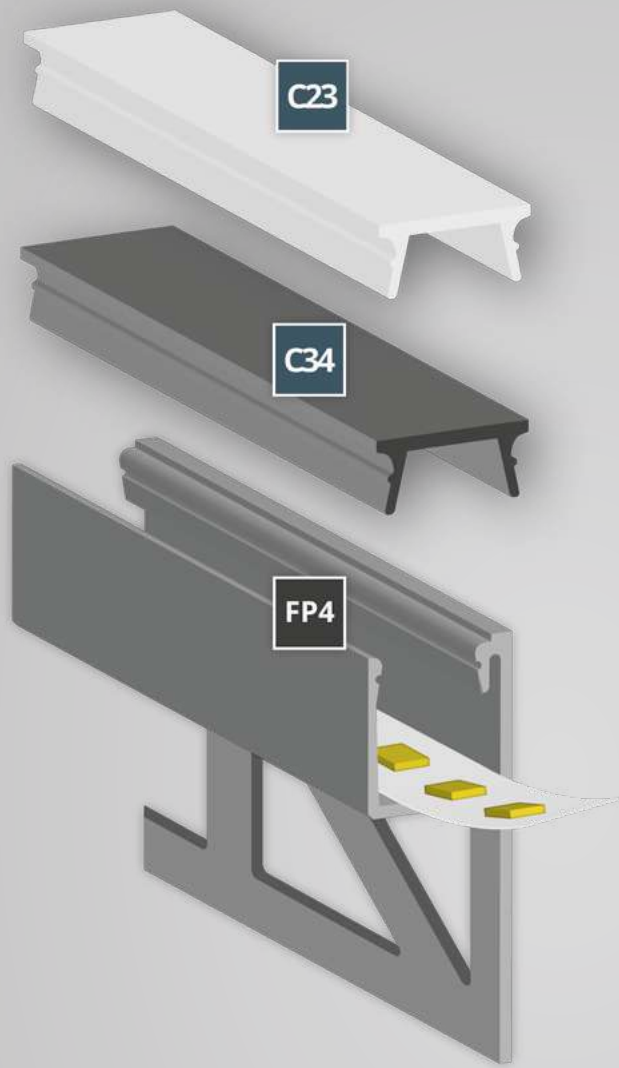

COVERS | ABDECKUNGEN

C23 65 % 200cm 300cm 600cm
 8600046 **8600116** **8600047**

C34 85 % 200cm 600cm
 8600074 **8600075**

PROFILE

FP4

200 cm 8123176	200 cm 8123320
250 cm 8123177	300 cm 8123321
300 cm 8123220	

END CAPS | ENDKAPPEN

E220 E220
8102321 E220
8304024

E221 E221
8102322 E221
8304025

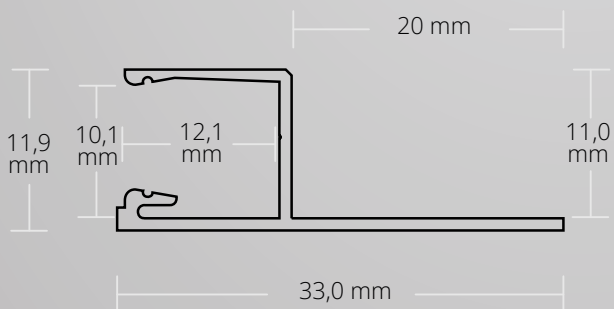



FP4 TILE | FLIESEN

Fliesenhöhe: 10 mm | Tile height: 10 mm | LED Strips max. 10 mm
11,9 mm x 33,0 mm | 129 g/m

200 cm
8123176

250 cm
8123177

300 cm
8123220

200 cm
8123320

300 cm
8123321

max.
10 mm

OEM

COVERS | ABDECKUNGEN

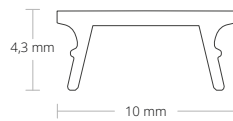

C23 opal | opal | 65 %

PC | 10,0 mm x 4,3 mm

200cm

8600046

300cm

8600116

600cm

8600047

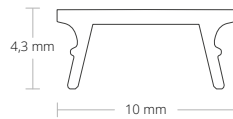

C34 black/matt | schwarz/matt | 25 %

PC | 10,0 mm x 4,3 mm

200cm

8600074

600cm

8600075

END CAPS | ENDKAPPEN



E220 PETG | 1 PCS/STK

E220
8102321

E220
8304024



E221 PETG | 1 PCS/STK | Cable/Kabel

E221
8102322

E221
8304025



FP5

TILE | FLIESEN

200 cm | 250 cm | 300 cm

max. 12 mm

OEM

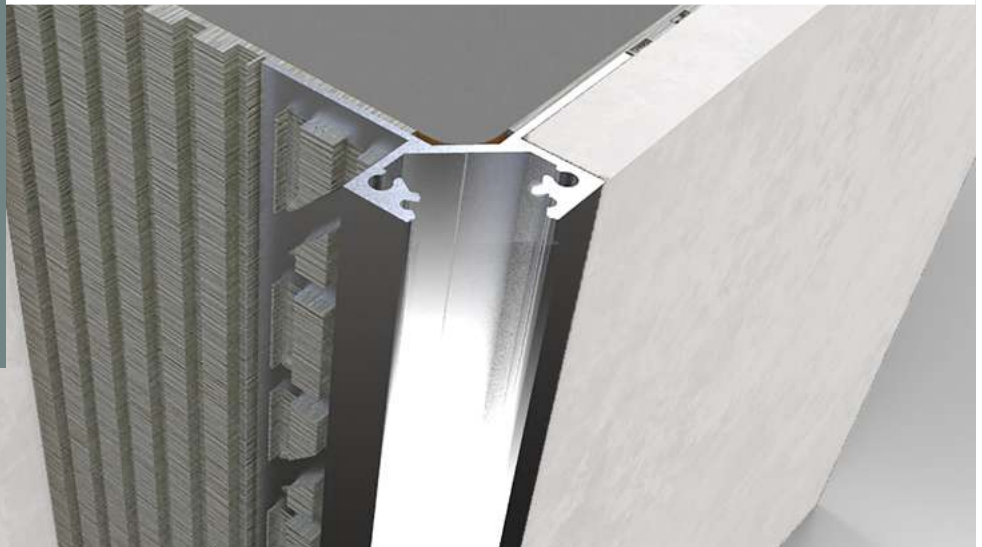
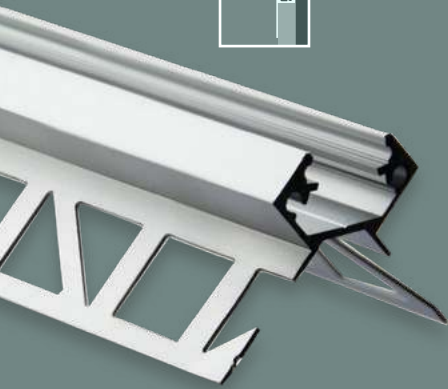

EXTENSION OF SERVICE LIFE
VERLÄNGERUNG LEBENSDAUER

MECHANICAL PROTECTION
MECHANISCHER SCHUTZ

COOLING
KÜHLUNG

HIGH LIGHT UTILISATION
HOHE LICHTVERWERTUNG

HOMOGENEOUS LIGHT
HOMOGENES LICHT

HOMOGENEOUS LIGHT with modular LED light solutions

- Bathrooms/WCs
Bad/WC
- Kitchens
Küche
- Utility rooms/cellars
Waschküche/Keller
- Technology rooms
Technikräume
- Spa and wellness areas
SPA- und Wellnessbereiche
- Swimming pools
Schwimm-/Hallenbäder
- Car washes
Autowaschanlagen/-waschstraßen
- Basically in any tile concept
Grundsätzlich in jedes Fliesenkonzept

Mounting/installation on/in wood Strips and plates, plasterboard, tiles, stone, granite, marble and metal surfaces
Montage/Einbau auf/in Holzleisten und -platten, Gipsplatten, Fliesen, Stein-, Granit-, Marmor- und Metalloberflächen



INSTALLATION INSTRUCTION
INSTALLATIONS MONTAGE





FP5

TILE | FLIESEN

Exterior corner | Außeneck | LED Strips max. 12 mm

Silver/Silber
ANODIZED | ELOXIERT



max. 12 mm



Designed for tile concepts!

This OUTER CORNER FP5 LED TILE profile is available in the standard lengths of 200 cm, 250 cm and 300 cm, and is designed for LED stripes with a maximum width of 12 mm. This profile system is filled in with tile adhesive on the rear, large-area wings (20 mm wide) on the outside in the vertical corners of a room and integrated into the tile concept.

These LED opal/satinised (65 % translucency), clear (85 % translucency), white/matt (translucency 75 %) or black matt (25 % translucency) are made of shatter-proof and flame-retardant polycarbonate (classification flammability UL94V-2), are flush-mounted and create homogeneous LED lighting conditions with high utilisation of the light output.

Important information:

The use in wet cells or outdoors is possible only in sealed form. Special protection against moisture and water is provided by silicone, which is applied to the joints for sealing purposes. Absolute watertightness is achieved for the LED profile systems by casting with Wepuran casting resin on polyurethane resin-basis (PUR).

When selecting the LED flex band, make sure that the protection class specified by the manufacturer (at least IP65) is maintained.

Design für Fliesenkonzepte!

Dieses FP5 LED FLIESEN-Profil AUSSENECK ist in den Standardlängen von 200 cm, 250 cm und 300 cm verfügbar und ist für LED Flexbänder mit einer maximalen Breite von 12 mm konzipiert. Dieses Profilsystem wird an den rückseitigen, großflächigen Flügeln (20 mm breit) außen an vertikale Ecken eines Raumes mit Fliesenkleber verspachtelt und in das Fliesenkonzept integriert.

Die LED Profilabdeckungen opal/satiniert (Lichtdurchlässigkeit 65 %), klar (Lichtdurchlässigkeit 85 %), weiß/matt (Lichtdurchlässigkeit 75 %) oder schwarz matt (Lichtdurchlässigkeit 25 %) bestehen aus bruchsicherem und schwer brennbarem Polycarbonat (Klassifizierung Brennbarkeit UL94V-2), schließen bündig ab und schaffen homogene LED Lichtverhältnisse mit hoher Verwertung der Lichtleistung.

Wichtiger Hinweis:

Der Einsatz in Nasszellen oder im Außenbereich ist ausschließlich nur in abgedichteter Form möglich. Besonderen Schutz vor Feuchtigkeit und Wasser bietet Silikon, das zum Abdichten auf die Verbindungsstellen aufgetragen wird. Absolute Wasserdichtheit erreicht man bei den LED Profilsystemen mit dem Vergießen mit Wepuran-Gießharz auf Polyurethanharzbasis (PUR).

Achten Sie bei der Wahl des LED Strips auf die herstellerseitig angegebene Schutzart (mindestens IP65).

GALAXY profiles
Perfect Light Lines

FP5 + C1

max.
12 mm

OEM



GALAXY profiles
Perfect Light Lines

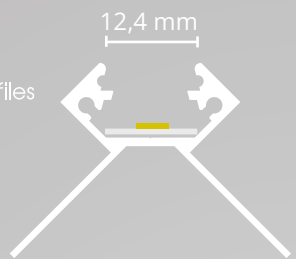

COVERS | ABDECKUNGEN

C1 65 %	200cm 8600004	250 cm 8600026	300 cm 8600080	600 cm 8600037
C2 85 %	200 cm 8600003	250 cm 8600135	300 cm 8600136	
C58 75 %	200 cm 8600154			
C32 25 %	200 cm 8600070	300 cm 8600103	600 cm 8600071	

END CAPS | ENDKAPPEN

E204	E204 81023005	E205	E205 81023006
-------------	------------------	-------------	------------------

PROTECTIVE COVER | SCHUTZCOVER

C1S	500 cm 8600065
------------	-------------------

PROFILE

FP5	200 cm 8102036	250 cm 8102037	300 cm 8102136
------------	-------------------	-------------------	-------------------

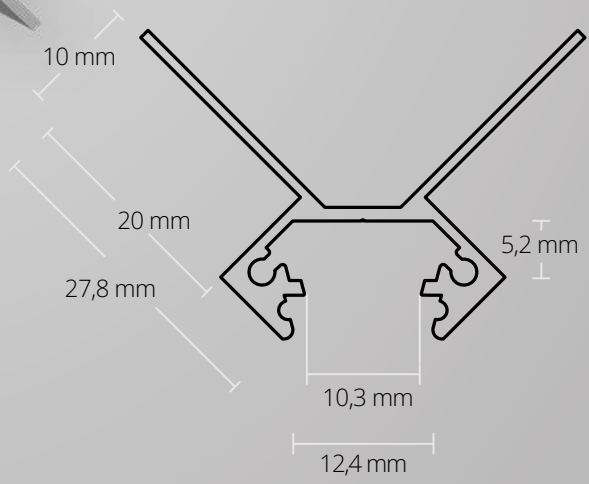

FP5 TILE | FLIESEN

Exterior corner | Außeneck | LED Strips max. 12 mm

27,8 mm x 27,8 mm | 224 g/m

200 cm **8102036**
 250 cm **8102037**
 300 cm **8102136**

max.
12 mm



OEM



COVERS | ABDECKUNGEN



C1 opal | opal | 65 %

PC | 13,8 mm x 4,4 mm

200cm **8600004** 250cm **8600026** 300cm **8600080** 600cm **8600037**



C2 clear | klar | 85 %

PC | 13,8 mm x 4,4 mm

200cm **8600003** 250cm **8600135** 300cm **8600136**



C58 white/matt | weiß/matt | 75 %

PC | 13,8 mm x 4,4 mm

200cm **8600154**

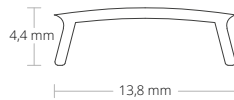

C32 black/matt | schwarz/matt | 25 %

PC | 13,8 mm x 4,4 mm

200cm **8600070** 300cm **8600103** 600cm **8600071**

END CAPS | ENDKAPPEN



E204 PETG | 1 PCS/STK

E204 **81023005**



E205 PETG | 1 PCS/STK | Cable/Kabel

E205 **81023006**

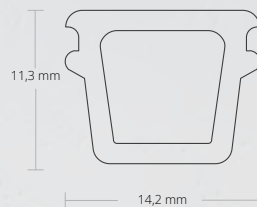

C1S Protective cover | Schutzcover

14,2 mm x 11,3 mm

500 cm **8600065**

The protective covers C1S and C10S soft are clicked into the aluminium profile for protection after the installation of drywall and tile profiles. The high-quality soft PVC is very robust and withstands the pressure of filling/plastering or painting. The protective cover prevents putty, glue, sealing material, silicone or paint from penetrating into the interior. Then the protective cover is removed, cleaned and is reusable several times over. Finally, the cover (PC) can be inserted into the profile.

Die Schutzcover C1S und C10S soft werden nach der Montage von Trockenbau- und Fliesenprofilen in das Alu-Profil zum Schutz eingeklickt. Das hochwertige Soft-PVC ist sehr robust und hält dem Druck beim Verspachteln/-putzen oder Streichen stand. Das Schutzcover verhindert, dass Spachtelmasse, Kleber, Dichtmaterial, Silikon oder Farbe in den Innenraum eindringt. Danach wird das Schutzcover abgenommen, gereinigt und ist vielfach wiederverwendbar. Abschließend kann die Abdeckung (PC) in das Profil eingesetzt werden.



FP8V2

TILE | FLIESEN

200 cm | 250 cm | 300 cm

max. 12 mm

OEM

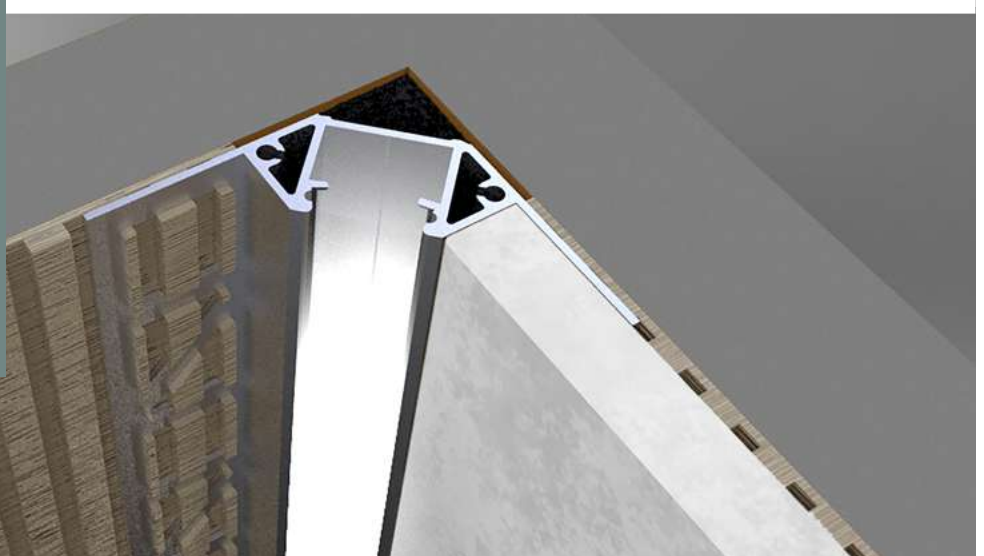
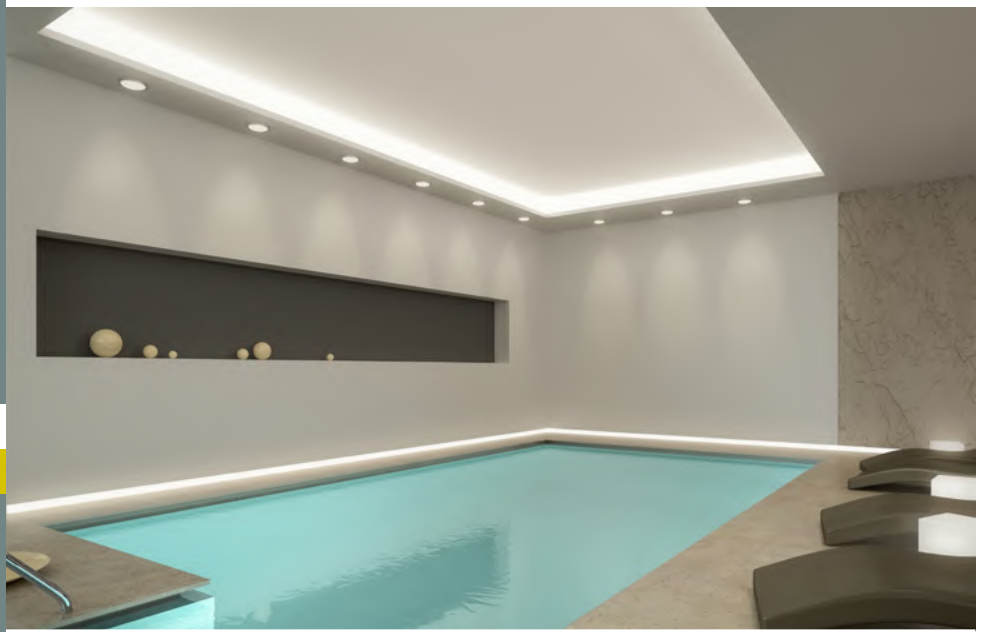
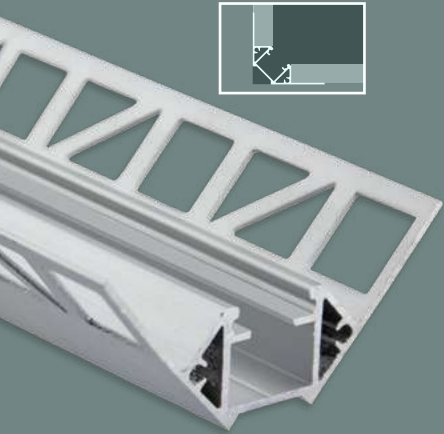
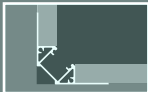

EXTENSION OF SERVICE LIFE
VERLÄNGERUNG LEBENSDAUER

MECHANICAL PROTECTION
MECHANISCHER SCHUTZ

COOLING
KÜHLUNG

HIGH LIGHT UTILISATION
HOHE LICHTVERWERTUNG

HOMOGENEOUS LIGHT
HOMOGENES LICHT

HOMOGENEOUS LIGHT with modular LED light solutions

- Bathrooms/WCs
Bad/WC
- Kitchens
Küche
- Utility rooms/cellars
Waschküche/Keller
- Technology rooms
Technikräume
- Spa and wellness areas
SPA- und Wellnessbereiche
- Swimming pools
Schwimm-/Hallenbäder
- Car washes
Autowaschanlagen/-waschstraßen
- Basically in any tile concept
Grundsätzlich in jedes Fliesenkonzept

Mounting/installation on/in wood Strips and plates, plaster-board, tiles, stone, granite, marble and metal surfaces
Montage/Einbau auf/in Holzleisten und -platten, Gipsplatten, Fliesen, Stein-, Granit-, Marmor- und Metalloberflächen

INSTALLATION INSTRUCTION
INSTALLATIONS MONTAGE



FP8V2

TILE | FLIESEN

Interior corner | Inneneck | LED Strips max. 12 mm

Silver/Silber
ANODIZED | ELOXIERT



max. 12 mm

max.
12 mm

OEM



Designed for tile concepts!

This INNER CORNER FP8 V2 LED TILE profile is available in the standard lengths of 200 cm, 250 cm and 300 cm, and is designed for LED stripes with a maximum width of 12 mm. In the back cavity of the aluminium profile, the connecting cables are protected and securely laid. This profile system is filled in with tile adhesive on the lateral, large-area wings (20 mm wide) in vertical corners of a room and thus integrated into the tile concept.

These LED opal/satinised (65 % translucency), clear (85 % translucency), white/matt (translucency 75 %) or black matt (25 % translucency) are made of shatter-proof and flame-retardant polycarbonate (classification flammability UL94V-2), are flush-mounted and create homogeneous LED lighting conditions with high utilisation of the light output.

Important information:

The use in wet cells or outdoors is possible only in sealed form. Special protection against moisture and water is provided by silicone, which is applied to the joints for sealing purposes. Absolute watertightness is achieved for the LED profile systems by casting with Wepuran casting resin on polyurethane resin-basis (PUR).

When selecting the LED flex band, make sure that the protection class specified by the manufacturer (at least IP65) is maintained.

Design für Fliesenkonzepte!

Dieses FP8 V2 LED FLIESEN-Profil INNENECK ist in den Standardlängen 200 cm, 250 cm und 300 cm verfügbar und ist für LED Flexbänder mit einer maximalen Breite von 12 mm konzipiert. Im rückseitigen Hohlraum des Alu-Profiles werden die Anschlussleitungen geschützt und sicher verlegt. Dieses Profilsystem wird an den seitlichen, großflächigen Flügeln (20 mm breit) in vertikale Ecken eines Raumes mit Fliesenkleber verspachtelt und damit in das Fliesenkonzept integriert.

Die LED Profilabdeckungen opal/satiniert (Lichtdurchlässigkeit 65 %), klar (Lichtdurchlässigkeit 85 %), weiß/matt (Lichtdurchlässigkeit 75 %) oder schwarz matt (Lichtdurchlässigkeit 25 %) bestehen aus bruchsicherem und schwer brennbarem Polycarbonat (Klassifizierung Brennbarkeit UL94V-2), schließen bündig ab und schaffen homogene LED Lichtverhältnisse mit hoher Verwertung der Lichtleistung.

Wichtiger Hinweis:

Der Einsatz in Nasszellen oder im Außenbereich ist ausschließlich nur in abgedichteter Form möglich. Besonderen Schutz vor Feuchtigkeit und Wasser bietet Silikon, das zum Abdichten auf die Verbindungsstellenaufgetragen wird. Absolute Wasserdichtheit erreicht man bei den LED Profilsystemen mit dem Vergießen mit Wepuran-Gießharz auf Polyurethanharzbasis (PUR).

Achten Sie bei der Wahl des LED Strips auf die herstellerseitig angegebene Schutzart (mindestens IP65).

GALAXY profiles
Perfect Light Lines

FP8 V2 + C1



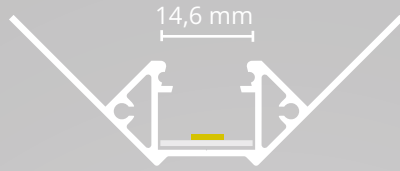

- max. 12 mm
- OEM
-



COVERS | ABDECKUNGEN

C1 65 %	200cm 8600004	250 cm 8600026	300 cm 8600080	600 cm 8600037
C2 85 %	200 cm 8600003	250 cm 8600135	300 cm 8600136	
C58 75 %	200 cm 8600154			
C32 25 %	200 cm 8600070	300 cm 8600103	600 cm 8600071	

END CAPS | ENDKAPPEN

E206	E206 81023007	E207	E207 81023008
-------------	------------------	-------------	------------------

PROTECTIVE COVER | SCHUTZCOVER

C1S	500 cm 8600065
------------	-------------------

PROFILE

FP8 V2	200 cm 8102230
	250 cm 8102231
	300 cm 8102232

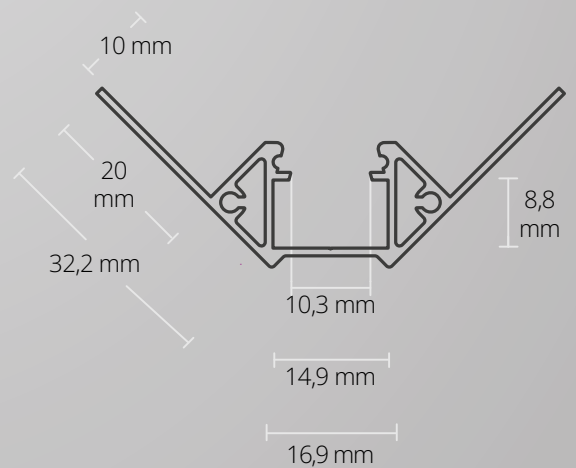



FP8V2 TILE | FLIESEN

Interior corner | Inneneck | LED Strips max. 12 mm
43 mm x 43 mm | 403 g/m

200 cm **8102230** 250 cm **8102231** 300 cm **8102232**

max.
12 mm



OEM



COVERS | ABDECKUNGEN



C1 opal | opal | 65 %

PC | 13,8 mm x 4,4 mm

200cm **8600004** 250cm **8600026** 300cm **8600080** 600cm **8600037**



C2 clear | klar | 85 %

PC | 13,8 mm x 4,4 mm

200cm **8600003** 250cm **8600135** 300cm **8600136**



C58 white/matt | weiß/matt | 75 %

PC | 13,8 mm x 4,4 mm

200cm **8600154**



C32 black/matt | schwarz/matt | 25 %

PC | 13,8 mm x 4,4 mm

200cm **8600070** 300cm **8600103** 600cm **8600071**

END CAPS | ENDKAPPEN

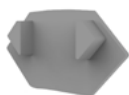

E206 PETG | 1 PCS/STK

E206 **81023007**



E207 PETG | 1 PCS/STK | Cable/Kabel

E207 **81023008**

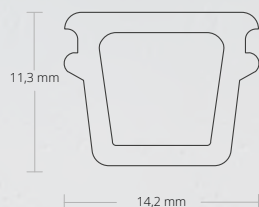

C1S Protective cover | Schutzcover

14,2 mm x 11,3 mm

500 cm **8600065**

The protective covers C1S and C10S soft are clicked into the aluminium profile for protection after the installation of drywall and tile profiles. The high-quality soft PVC is very robust and withstands the pressure of filling/plastering or painting. The protective cover prevents putty, glue, sealing material, silicone or paint from penetrating into the interior. Then the protective cover is removed, cleaned and is reusable several times over. Finally, the cover (PC) can be inserted into the profile.

Die Schutzcover C1S und C10S soft werden nach der Montage von Trockenbau- und Fliesenprofilen in das Alu-Profil zum Schutz eingeklickt. Das hochwertige Soft-PVC ist sehr robust und hält dem Druck beim Verspachteln/-putzen oder Streichen stand. Das Schutzcover verhindert, dass Spachtelmasse, Kleber, Dichtmaterial, Silikon oder Farbe in den Innenraum eindringt. Danach wird das Schutzcover abgenommen, gereinigt und ist vielfach wiederverwendbar. Abschließend kann die Abdeckung (PC) in das Profil eingesetzt werden.



PI3V2

RECESSED | EINBAU

200 cm

max. 13 mm

OEM

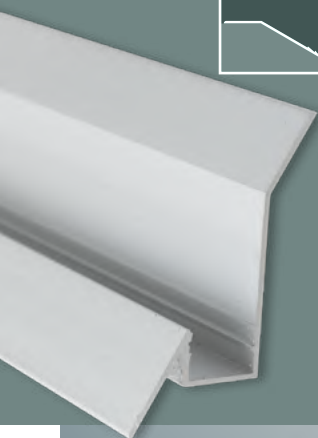

EXTENSION OF SERVICE LIFE
VERLÄNGERUNG LEBENSDAUER

MECHANICAL PROTECTION
MECHANISCHER SCHUTZ

COOLING
KÜHLUNG

HIGH LIGHT UTILISATION
HOHE LICHTVERWERTUNG

HOMOGENEOUS LIGHT
HOMOGENES LICHT

HOMOGENEOUS LIGHT with modular LED light solutions

- Wall, ceiling or floor mounting
Wand-, Decken- oder Bodenmontage
- Homes
Wohnräume
- Offices and reception areas
Büroräume und Empfangsbereiche
- Hotel and gastronomy
Hotellerie und Gastronomie
- Retail (shop or showroom windows)
Einzelhandel (Shop- und Schaufenster)
- Shop floors and showrooms
Geschäftsflächen und Showrooms
- Hair/beauty/body art studios
Friseur-/Beauty-/Body-Art-Studios
- Halls, foyers and corridors
Hallen, Foyers und Flure
- Common rooms
Aufenthaltsräume
- Waiting rooms
Ordnationen und Wartezimmer

Mounting/installation on/in wood Strips and plates, plasterboard, tiles, stone, granite, marble and metal surfaces
Montage/Einbau auf/in Holzleisten und -platten, Gipsplatten, Fliesen, Stein-, Granit-, Marmor- und Metalloberflächen



PI3V2

RECESSED | EINBAU

Indirect | indirekt | LED Strips max. 13 mm

Silver/Silber
ANODIZED | ELOXIERT



max. 13 mm

max.
13 mm

OEM



Indirect and glare-free - ideal for suspended ceilings, interior walls and drywall!

The PI3 V2 LED RECESSED Profile is 200cm long as standard and made from high-quality aluminium (anodised). This profile is especially slim in design, letting it very subtly blend into walls and ceilings. It is fixed into recesses with adhesive.

An LED flex strip up to a maximum of 13mm in width can be fixed into the cavity of the PI3 V2 LED RECESSED Profile with adhesive. This profile is especially well suited to atmospheric effect lighting or as general room lighting with the right high-performance LED flex strips.

Indirekt und blendfrei - ideal für Zwischendecken/-wände und Trockenbau!

Das PI3 V2 LED EINBAU-Profil hat eine Standardlänge von 200 cm und wird aus qualitativ hochwertigem Aluminium (eloxiert) gefertigt. Das Profil ist besonders schlank konzipiert und lässt sich sehr dezent in Wände und Decken einfügen. Es wird in die Aussparungen eingeklebt.

Im Innenraum des PI3 V2 LED EINBAU-Profiles wird ein LED Strip mit einer maximalen Breite von 13 mm eingeklebt. Dieses Profil eignet sich besonders als inszenierende Effektbeleuchtung oder mit entsprechend leistungsstarken LED Flexbändern als allgemeine Raumbeleuchtung.

GALAXY profiles
Perfect Light Lines

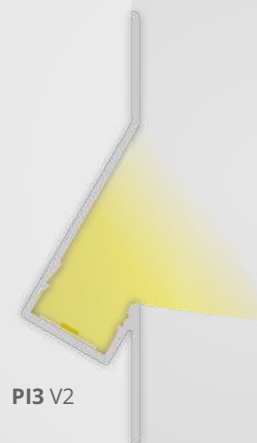

PI3 V2

- max. 13 mm
- OEM
- Water drop icon

GALAXY profiles
Perfect Light Lines

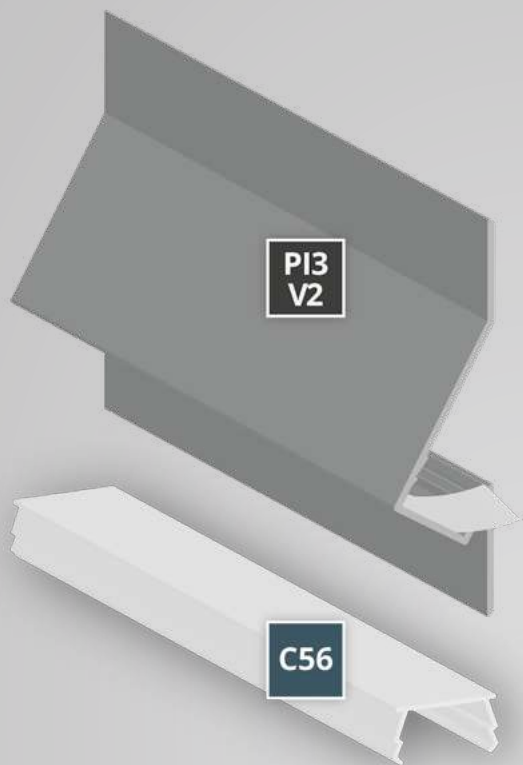

COVERS | ABDECKUNGEN

C56 65 % 200cm
8600133

PROFILE

PI3 200 cm
V2 8108001

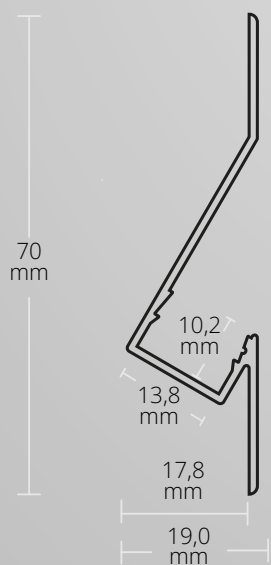



PI3V2 RECESSED | EINBAU
Indirect | indirekt | LED Strips max. 13 mm
19,0 mm x 70 mm | 329 g/m

200 cm
8108001

max.
13 mm



OEM



COVERS | ABDECKUNGEN

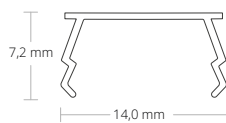

C56 opal | opal | 65 %
PC | 14,0 mm x 7,2 mm
200cm
8600133



TBP1

DRYWALL | TROCKENBAU

200 cm

max. 6 mm

OEM



EXTENSION OF SERVICE LIFE
VERLÄNGERUNG LEBENSDAUER

MECHANICAL PROTECTION
MECHANISCHER SCHUTZ

COOLING
KÜHLUNG

HIGH LIGHT UTILISATION
HOHE LICHTVERWERTUNG

HOMOGENEOUS LIGHT
HOMOGENES LICHT

HOMOGENEOUS LIGHT with modular LED light solutions

- Homes
Wohnräume
- Offices, conference and presentation rooms
Büro-, Konferenz- und Präsentationsräume
- Waiting rooms
Ordinationen
- Business premises and sales floors
Geschäfts- und Verkaufsflächen
- Showrooms
- Hotel and gastronomy
Hotellerie und Gastronomie
- Foyers, corridors and connecting rooms
Foyers, Flure und Verbindungsräume
- Waiting and common rooms
Warte- und Aufenthaltsräume
- Commercial premises (e.g. hair salons)
Gewerbliche Dienstleistungsräumlichkeiten (z. B. Friseursalons etc.)

Mounting/installation on/in plasterboard
Montage/Einbau auf/in Gipsplatten



INSTALLATION INSTRUCTION
INSTALLATIONS MONTAGE







TBP1

DRYWALL | TROCKENBAU

LED Strips max. 6 mm

Silver/Silber
ANODIZED | ELOXIERT

RAL 9005 Black/Schwarz
POWDER-COATED | PULVERBESCHICHTET



max. 6 mm

max.
6 mm

OEM



Sustainable light integration into the architecture

These innovative LED aluminium profiles are the perfect solution for comprehensive lighting concepts in modern drywall construction. Light source and architectural design element in one!

The TBP1 LED drywall profile comes as standard in a length of 200 cm, is made of high quality aluminium (anodised) and also available in black (RAL 9005 - powder coated). It is designed for LED strips with a max. width of 6 mm and is installed in the false ceiling as a shadow gap. The profile can be integrated directly into the frame construction. The gypsum boards are inserted flush into the guide of the profile.

For a homogeneous and glare-free light line, the flat standard profile cover made of unbreakable and flame-retardant polycarbonate (UL94 V-2 flammability rating - opal/satin finish - light transmittance 65 %) is clicked into the ALU profile. The cover is also available in 600 cm.

Nachhaltige Licht-Integration in die Architektur

Diese innovativen LED Alu-Profile sind die perfekte Lösung für ganzheitliche Beleuchtungskonzepte im modernen Trockenbau. Lichtquelle und architektonisches Designelement in einem!

Das TBP1 LED Trockenbau-Profil wird standardmäßig in der Länge 200 cm geliefert, ist aus hochwertigem Aluminium (eloxiert) gefertigt und auch in der Farbe Schwarz (RAL 9005 - pulverbeschichtet) verfügbar. Es ist für LED Strips mit einer max. Breite von 6 mm konzipiert und wird als Schattenfuge in der Zwischendecke verbaut. Das Profil kann direkt in die Rahmenkonstruktion integriert werden. Die Gipsplatten werden bündig in die Führung des Profils eingeschoben.

Für eine homogene und blendfreie Lichtlinie wird die flache Standard-Profilabdeckung aus bruchsicherem und schwer brennbarem Polycarbonat (Klassifizierung Brennbarkeit UL94 V-2 - opal/satiniert - Lichtdurchlässigkeit 65 %) in das ALU-Profil eingeklickt. Das Cover ist auch in 600 cm verfügbar.

GALAXY profiles
Perfect Light Lines

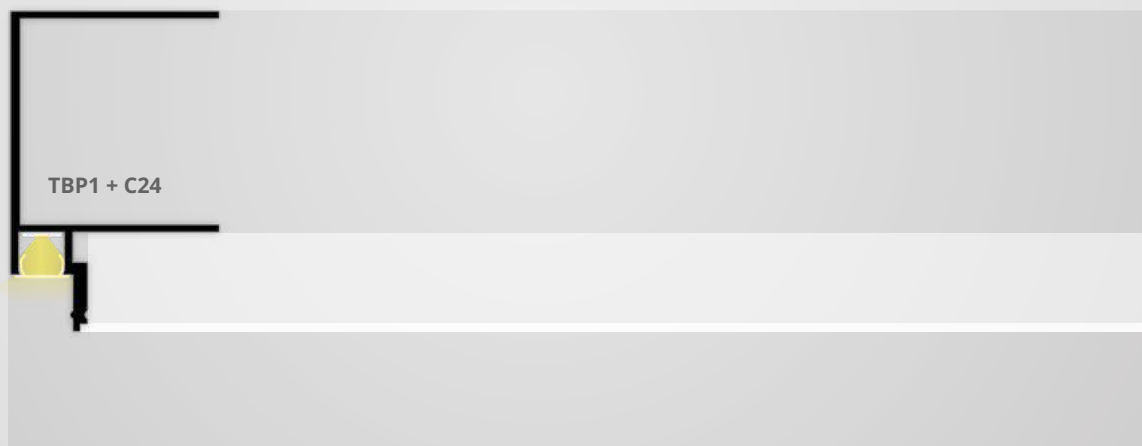

max.
6 mm

GALAXY profiles
Perfect Light Lines

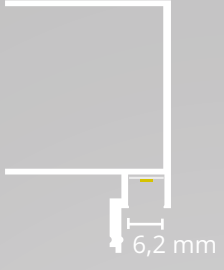

OEM

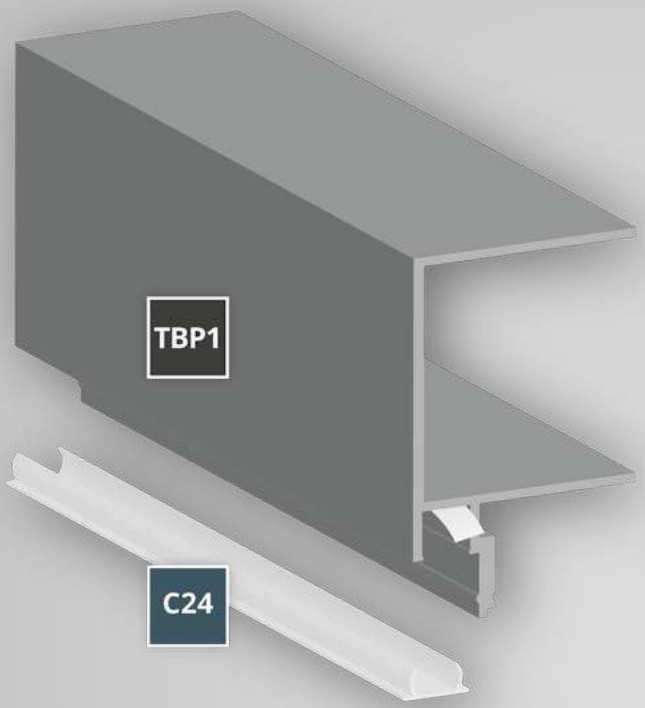

COVERS | ABDECKUNGEN

C24 65 % 200cm 600 cm
 8600106 8600107

PROFILE

TBP1 200 cm 200cm
 8102050 8102056

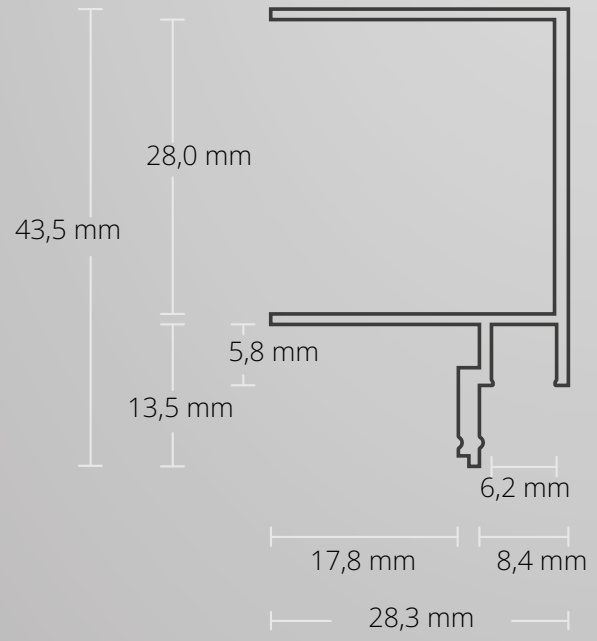



TBP1 DRYWALL | TROCKENBAU

LED Strips max. 6 mm
28,3 mm x 43,5 mm | 327 g/m

200 cm
8102050

200 cm
8102056

max.
6 mm



OEM



COVERS | ABDECKUNGEN

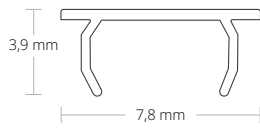

C24 opal | opal | 65 %
PC | 7,8 mm x 3,9 mm
200cm 600cm
8600106 **8600107**

TBP2

200 cm | 300 cm

max. 11 mm

OEM

TBP2.1

200 cm

max. 11 mm

OEM

**DRYWALL
TROCKENBAU**

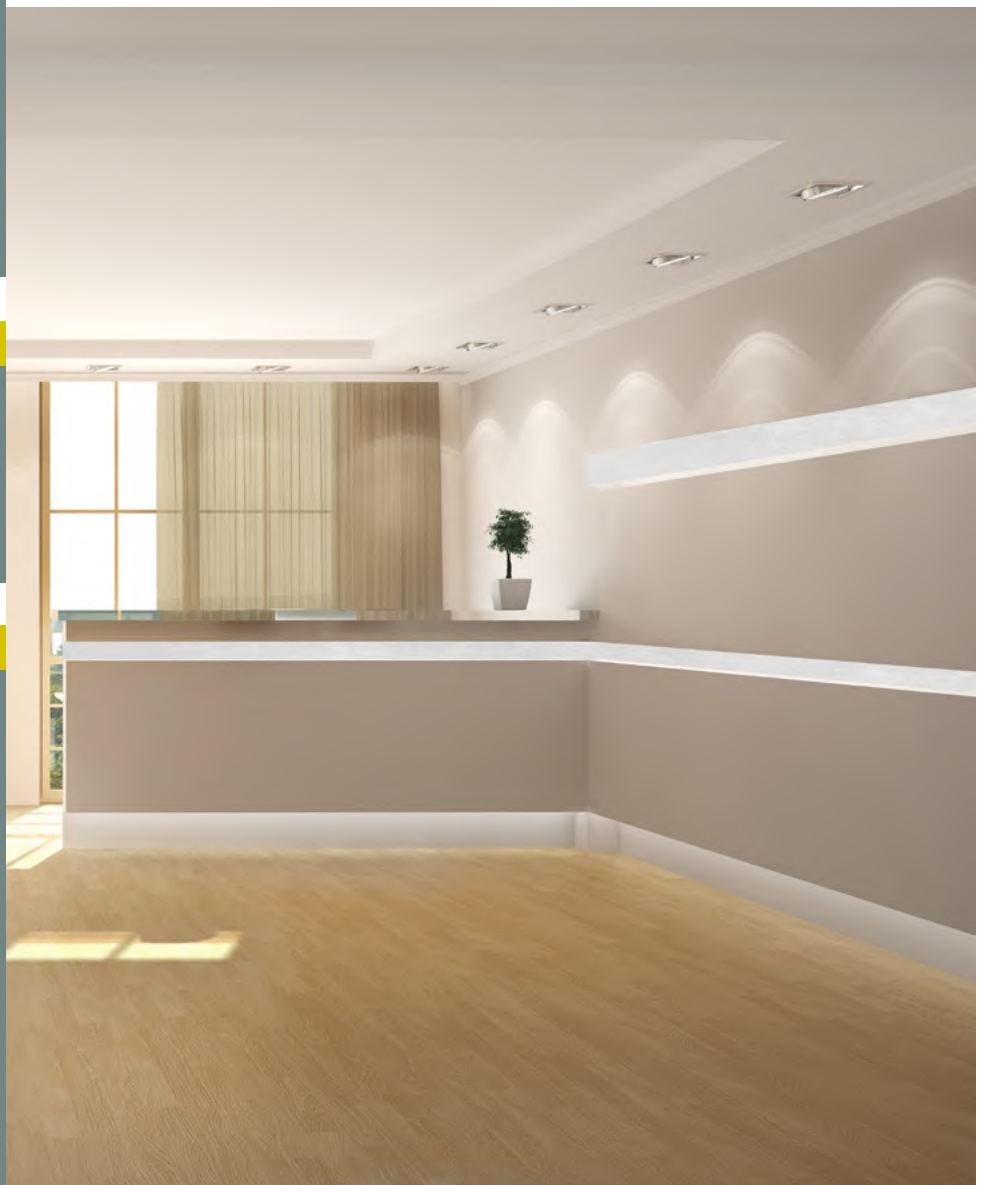

EXTENSION OF SERVICE LIFE
VERLÄNGERUNG LEBENSDAUER

MECHANICAL PROTECTION
MECHANISCHER SCHUTZ

COOLING
KÜHLUNG

HIGH LIGHT UTILISATION
HOHE LICHTVERWERTUNG

HOMOGENEOUS LIGHT
HOMOGENES LICHT

HOMOGENEOUS LIGHT with modular LED light solutions

- Homes
Wohnräume
- Offices, conference and presentation rooms
Büro-, Konferenz- und Präsentationsräume
- Waiting rooms
Ordinationen
- Business premises and sales floors
Geschäfts- und Verkaufsflächen
- Showrooms
- Hotel and gastronomy
Hotellerie und Gastronomie
- Foyers, corridors and connecting rooms
Foyers, Flure und Verbindungsräume
- Waiting and common rooms
Warte- und Aufenthaltsräume
- Commercial premises (e.g. hair salons)
Gewerbliche Dienstleistungsräumlichkeiten (z. B. Friseursalons etc.)

Mounting/installation on/in plasterboard
Montage/Einbau auf/in Gipsplatten

INSTALLATION INSTRUCTION
INSTALLATIONS MONTAGE



TBP2

DRYWALL | TROCKENBAU

LED Strips max. 11 mm

Silver/Silber
ANODIZED | ELOXIERT

RAL 9003 White/Weiß
POWDER-COATED | PULVERBESCHICHTET



max. 11 mm

max.
11 mm

OEM



Sustainable light integration into the architecture

These innovative LED aluminium profiles are the perfect solution for comprehensive lighting concepts in modern drywall construction. Light source and architectural design element in one!

The TBP2 LED drywall profile comes as standard in a length of 200 cm and is made of high quality aluminium (anodised). It is designed for LED strips with a max. width of 11 mm and ideally suited for the professional realisation of cove lighting solutions. The profile can be filled in and plastered and can be integrated directly into the frame construction. The gypsum boards are flush with the profile.

For a homogeneous and glare-free light line, the flat standard profile cover made of unbreakable and flame-retardant polycarbonate (UL94 V-2 flammability rating - opal/satin finish - light transmittance 65 %) is clicked into the ALU profile. The cover is also available in 300 cm.

The result is sustainable indirect LED lighting!

Nachhaltige Licht-Integration in die Architektur

Diese innovativen LED Alu-Profilen sind die perfekte Lösung für ganzheitliche Beleuchtungskonzepte im modernen Trockenbau. Lichtquelle und architektonisches Designelement in einem!

Das TBP2 LED Trockenbau-Profil wird standardmäßig in der Länge 200 cm geliefert und ist aus hochwertigem Aluminium (eloxiert) gefertigt. Es ist für LED Strips mit einer max. Breite von 11 mm konzipiert und ideal für die professionelle Realisierung von Vouten-Lichtlösungen geeignet. Das Profil kann verspachtelt und verputzt werden und lässt sich direkt in die Rahmenkonstruktion integrieren. Die Gipsplatten schließen bündig am Profil ab.

Für eine homogene und blendfreie Lichtlinie wird die flache Standard-Profilabdeckung aus bruchsicherem und schwer brennbarem Polycarbonat (Klassifizierung Brennbarkeit UL94 V-2 - opal/satiniert - Lichtdurchlässigkeit 65 %) in das ALU-Profil eingeklickt. Das Cover ist auch in 300 cm verfügbar.

Das Resultat ist eine nachhaltige indirekte LED Beleuchtung!

GALAXY profiles
Perfect Light Lines



max.
11 mm

OEM



GALAXY profiles
Perfect Light Lines

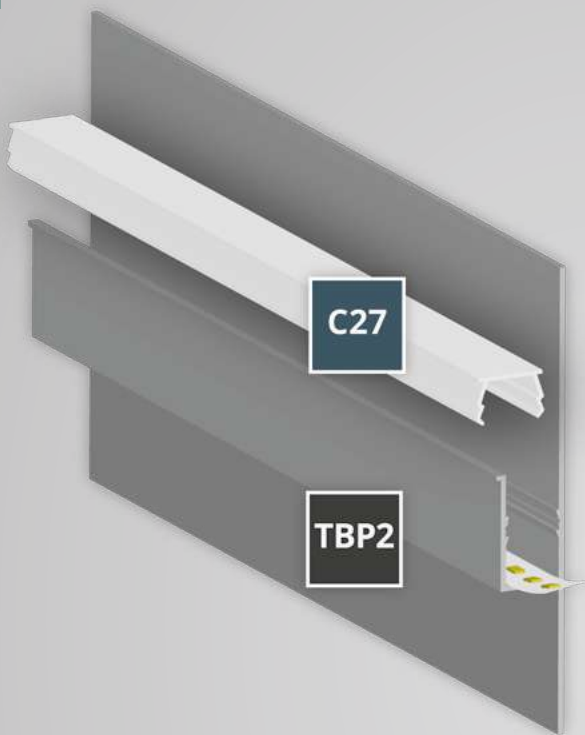

COVERS | ABDECKUNGEN

C27 65 % 200cm 300cm
8600084 8600113

PROFILE

TBP2 200 cm 300 cm 200cm 300cm
8102040 8102140 8103040 8103140

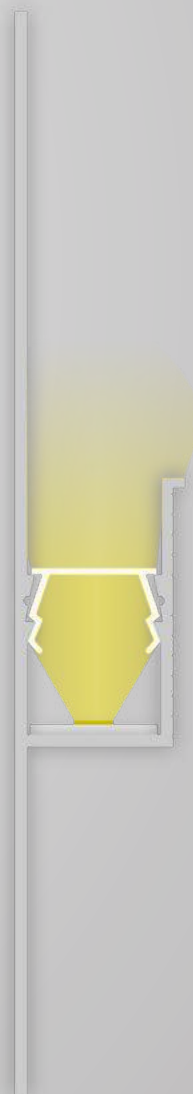
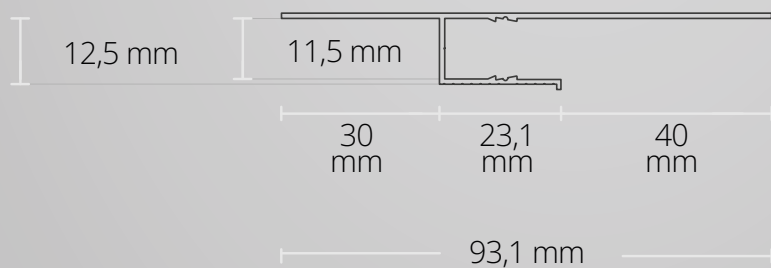



TBP2 DRYWALL | TROCKENBAU

LED Strips max. 11 mm

12,5 mm x 93,1 mm | 433 g/m

200 cm
8102040

300 cm
8102140

200 cm
8103040

300 cm
8103140

max.
11 mm

OEM



COVERS | ABDECKUNGEN

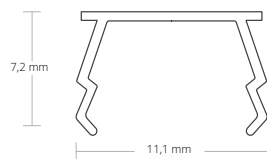

C27 opal | opal | 65 %

PC | 11,1 mm x 7,2 mm

200cm 300cm

8600084 8600113

- max. 11 mm
- OEM
- 

GALAXY profiles
Perfect Light Lines

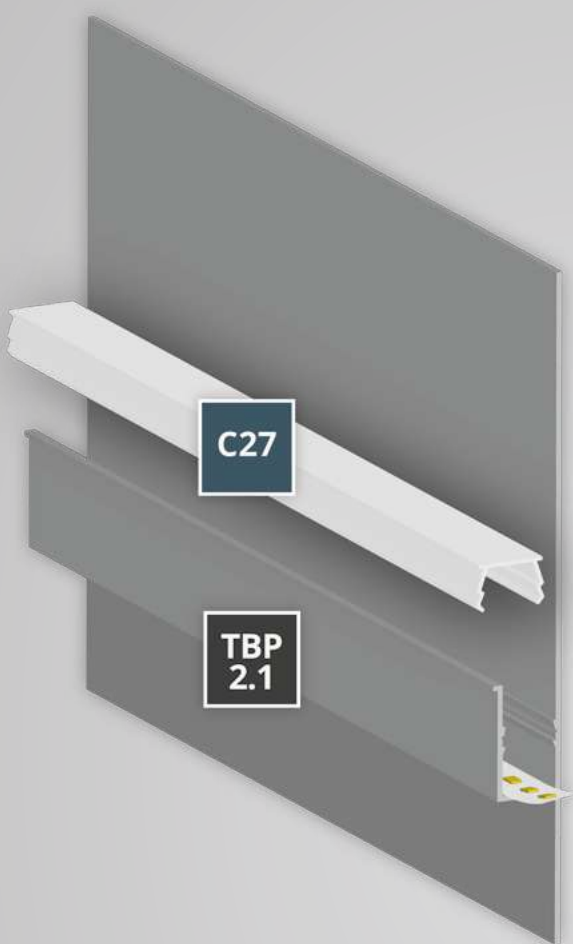

COVERS | ABDECKUNGEN

C27 65 % 200cm 300cm
8600084 8600113

PROFILE

TBP2.1 200 cm 200cm
8102041 8103041

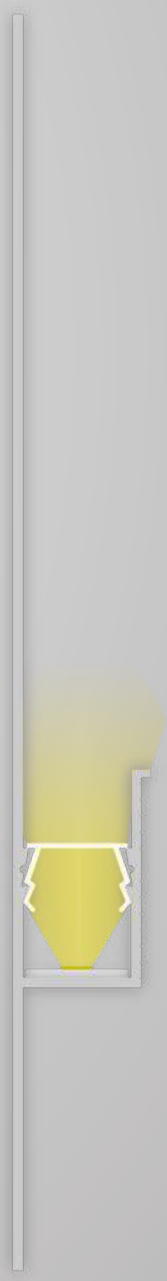
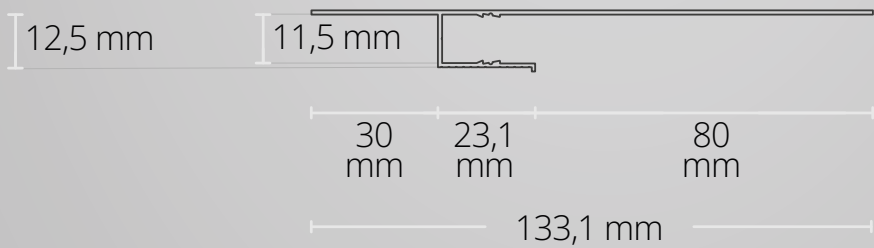



TBP2.1 DRYWALL | TROCKENBAU

LED Strips max. 11 mm

12,5 mm x 133,1 m | 600 g/m

200 cm
8102041

200 cm
8103041

max.
11 mm

OEM



COVERS | ABDECKUNGEN

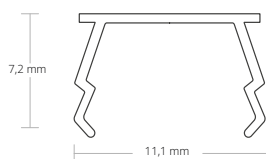

C27 opal | opal | 65 %

PC | 11,1 mm x 7,2 mm

200cm

300cm

8600084

8600113

TBP3

DRYWALL | TROCKENBAU

200 cm | 300 cm

max. 14 mm

OEM

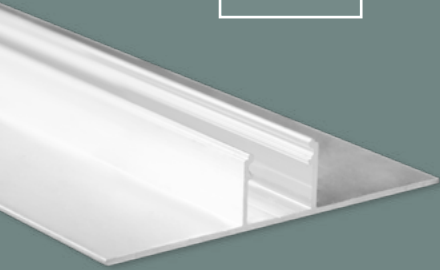

EXTENSION OF SERVICE LIFE
VERLÄNGERUNG LEBENSDAUER

MECHANICAL PROTECTION
MECHANISCHER SCHUTZ

COOLING
KÜHLUNG

HIGH LIGHT UTILISATION
HOHE LICHTVERWERTUNG

HOMOGENEOUS LIGHT
HOMOGENES LICHT

HOMOGENEOUS LIGHT with modular LED light solutions

- Homes
Wohnräume
- Offices, conference and presentation rooms
Büro-, Konferenz- und Präsentationsräume
- Waiting rooms
Ordinationen
- Business premises and sales floors
Geschäfts- und Verkaufsflächen
- Showrooms
- Hotel and gastronomy
Hotellerie und Gastronomie
- Foyers, corridors and connecting rooms
Foyers, Flure und Verbindungsräume
- Waiting and common rooms
Warte- und Aufenthaltsräume
- Commercial premises (e.g. hair salons)
Gewerbliche Dienstleistungsräumlichkeiten (z. B. Friseursalons etc.)

Mounting/installation on/in plasterboard
Montage/Einbau auf/in Gipsplatten

INSTALLATION INSTRUCTION
INSTALLATIONS MONTAGE

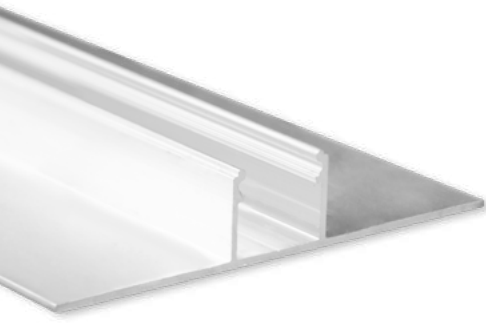

TBP3

DRYWALL | TROCKENBAU

LED Strips max. 14 mm

Silver/Silber
ANODIZED | ELOXIERT



max. 14 mm

max.
14 mm

OEM



Sustainable light integration into the architecture

These innovative LED aluminium profiles are the perfect solution for comprehensive lighting concepts in modern drywall construction. Light source and architectural design element in one!

The TBP3 LED drywall profile comes as standard in a length of 200 cm and 300 cm, is made of high quality aluminium (anodised). It is designed for LED strips with a max. width of 14 mm. For a homogeneous and glare-free light line, the flat standard profile cover made of unbreakable and flame-retardant polycarbonate (UL94 V-2 flammability rating - opal/satinised (65 % translucency), clear (85 % translucency), white/matt (translucency 75 %) or black matt (25 % translucency) is clicked into the ALU profile. The cover's wings cover the aluminium in the process. The profile is no longer visible.

The profile can be mounted horizontally and vertically with the gypsum boards. (Filling in and plastering possible). The gypsum boards are flush with the profile.

The result is sustainable indirect LED lighting!

Nachhaltige Licht-Integration in die Architektur

Diese innovativen LED Alu-Profile sind die perfekte Lösung für ganzheitliche Beleuchtungskonzepte im modernen Trockenbau. Lichtquelle und architektonisches Designelement in einem!

Das TBP3 LED Trockenbau-Profil wird standardmäßig in der Länge 200 cm und 300 cm geliefert und ist aus hochwertigem Aluminium (eloxiert) gefertigt. Es ist für LED Strips mit einer max. Breite von 14 mm konzipiert. Für eine homogene und blendfreie Lichtlinie wird die flache Standard-Profilabdeckung aus bruchsicherem und schwer brennbarem Polycarbonat (Klassifizierung Brennbarkeit UL94 V-2 - opal/satinisiert (Lichtdurchlässigkeit 65 %), klar (Lichtdurchlässigkeit 85 %), weiß/matt (Lichtdurchlässigkeit 75 %) oder schwarz matt (Lichtdurchlässigkeit 25 %) in das ALU-Profil eingeklickt. Dabei bedecken die Flügel des Covers das Aluminium. Das Profil ist nicht mehr sichtbar.

Das Profil kann horizontal und vertikal mit den Gipsplatten verbaut werden. (Verspachteln und Verputzen möglich). Die Gipsplatten schließen bündig am Profil ab.

Das Resultat ist eine nachhaltige indirekte LED Beleuchtung!

GALAXY profiles
Perfect Light Lines



TBP3 + C32

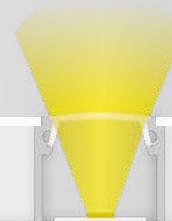

TBP3 + C2

max.
14 mm

OEM



GALAXY profiles
Perfect Light Lines

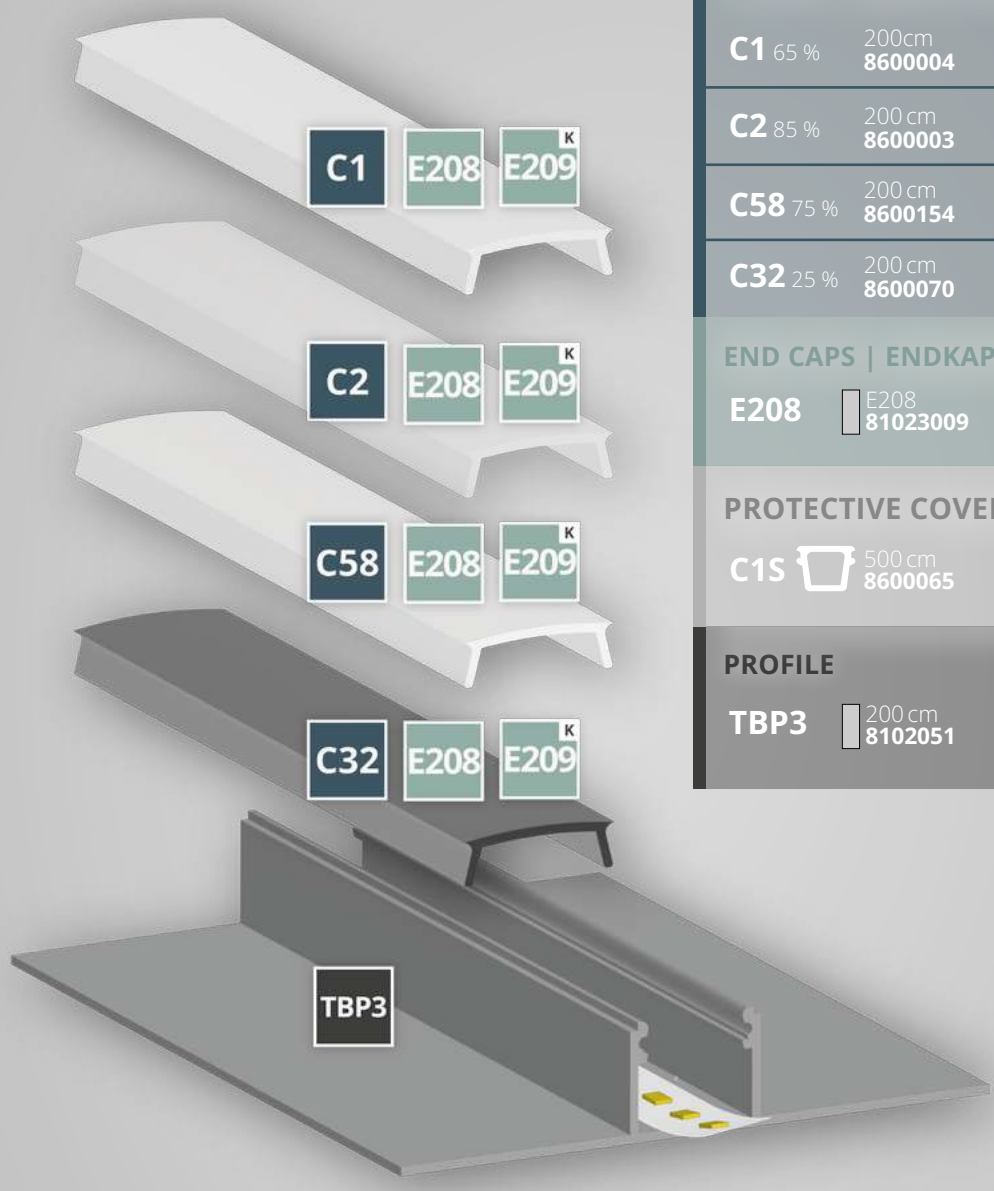
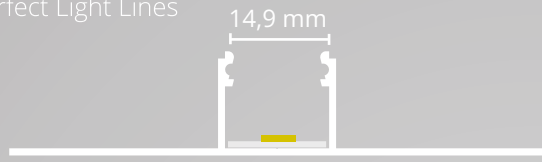

COVERS | ABDECKUNGEN

C1 65 %	200cm 8600004	250 cm 8600026	300 cm 8600080	600 cm 8600037
C2 85 %	200 cm 8600003	250 cm 8600135	300 cm 8600136	
C58 75 %	200 cm 8600154			
C32 25 %	200 cm 8600070	300 cm 8600103	600 cm 8600071	

END CAPS | ENDKAPPEN

E208	E208 81023009	E209	E209 81023010
-------------	------------------	-------------	------------------

PROTECTIVE COVER | SCHUTZCOVER

C1S	500 cm 8600065
------------	-------------------

PROFILE

TBP3	200 cm 8102051	300 cm 8102151
-------------	-------------------	-------------------

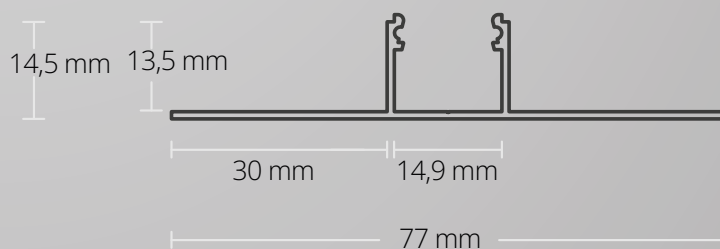

TBP3 DRYWALL | TROCKENBAU

LED Strips max. 14 mm
77 mm x 14,5 mm | 283 g/m

200 cm **8102051** | 300 cm **8102151**

max.
14 mm

OEM



COVERS | ABDECKUNGEN



C1 opal | opal | 65 %

PC | 13,8 mm x 4,4 mm

200cm **8600004** | 250cm **8600026** | 300cm **8600080** | 600cm **8600037**



C2 clear | klar | 85 %

PC | 13,8 mm x 4,4 mm

200cm **8600003** | 250cm **8600135** | 300cm **8600136**



C58 white/matt | weiß/matt | 75 %

PC | 13,8 mm x 4,4 mm

200cm **8600154**



C32 black/matt | schwarz/matt | 25 %

PC | 13,8 mm x 4,4 mm

200cm **8600070** | 300cm **8600103** | 600cm **8600071**

END CAPS | ENDKAPPEN



E208 PETG | 1 PCS/STK

E208 **81023009**



E209 PETG | 1 PCS/STK | Cable/Kabel

E209 **81023010**

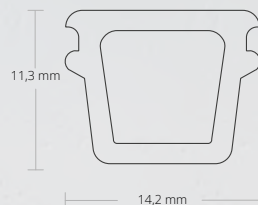

C1S Protective cover | Schutzcover

14,2 mm x 11,3 mm

500 cm **8600065**

The protective covers C1S and C10S soft are clicked into the aluminium profile for protection after the installation of drywall and tile profiles. The high-quality soft PVC is very robust and withstands the pressure of filling/plastering or painting. The protective cover prevents putty, glue, sealing material, silicone or paint from penetrating into the interior. Then the protective cover is removed, cleaned and is reusable several times over. Finally, the cover (PC) can be inserted into the profile.

Die Schutzcover C1S und C10S soft werden nach der Montage von Trockenbau- und Fliesenprofilen in das Alu-Profil zum Schutz eingeklickt. Das hochwertige Soft-PVC ist sehr robust und hält dem Druck beim Verspachteln/-putzen oder Streichen stand. Das Schutzcover verhindert, dass Spachtelmasse, Kleber, Dichtmaterial, Silikon oder Farbe in den Innenraum eindringt. Danach wird das Schutzcover abgenommen, gereinigt und ist vielfach wiederverwendbar. Abschließend kann die Abdeckung (PC) in das Profil eingesetzt werden.



TBP4

DRYWALL | TROCKENBAU

200 cm | 300 cm

max. 14 mm

OEM

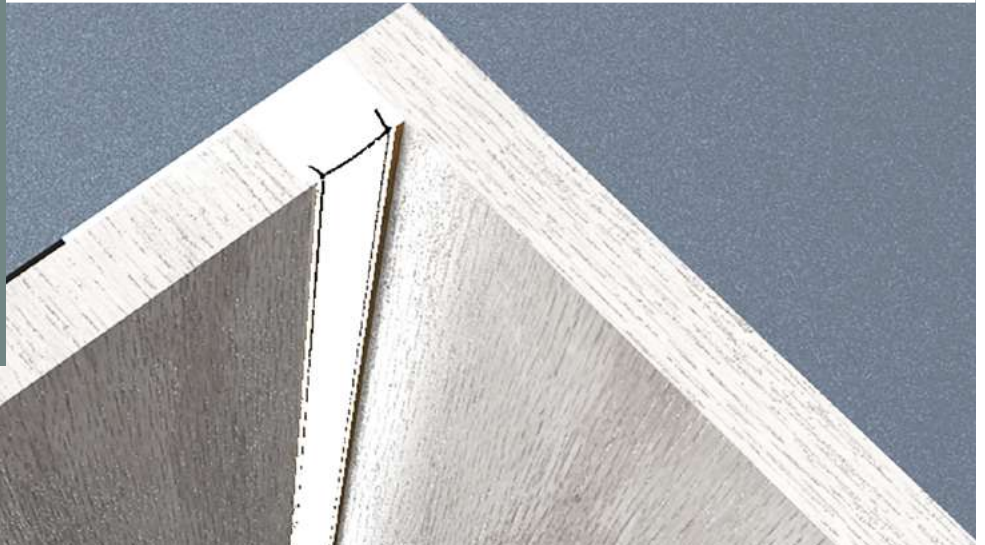
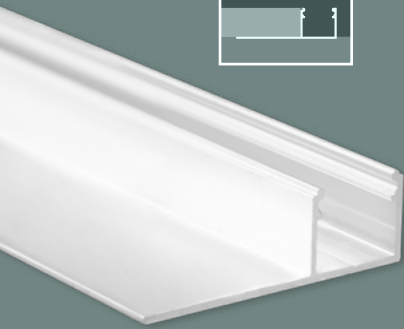

EXTENSION OF SERVICE LIFE
VERLÄNGERUNG LEBENSDAUER

MECHANICAL PROTECTION
MECHANISCHER SCHUTZ

COOLING
KÜHLUNG

HIGH LIGHT UTILISATION
HOHE LICHTVERWERTUNG

HOMOGENEOUS LIGHT
HOMOGENES LICHT

HOMOGENEOUS LIGHT with modular LED light solutions

- Homes
Wohnräume
- Offices, conference and presentation rooms
Büro-, Konferenz- und Präsentationsräume
- Waiting rooms
Ordinationen
- Business premises and sales floors
Geschäfts- und Verkaufsflächen
- Showrooms
- Hotel and gastronomy
Hotellerie und Gastronomie
- Foyers, corridors and connecting rooms
Foyers, Flure und Verbindungsräume
- Waiting and common rooms
Warte- und Aufenthaltsräume
- Commercial premises (e.g. hair salons)
Gewerbliche Dienstleistungsräumlichkeiten (z. B. Friseursalons etc.)

Mounting/installation on/in plasterboard
Montage/Einbau auf/in Gipsplatten

INSTALLATION INSTRUCTION
INSTALLATIONS MONTAGE



TBP4

DRYWALL | TROCKENBAU

LED Strips max. 14 mm

Silver/Silber
ANODIZED | ELOXIERT



max. 14 mm

max.
14 mm

OEM



Sustainable light integration into the architecture

These innovative LED aluminium profiles are the perfect solution for comprehensive lighting concepts in modern drywall construction. Light source and architectural design element in one!

The TBP4 LED drywall profile comes as standard in a length of 200 cm and is made of high quality aluminium (anodised). It is designed for LED strips with a max. width of 14 mm. For a homogeneous and glare-free light line, the flat standard profile cover made of unbreakable and flame-retardant polycarbonate (UL94 V-2 flammability rating - opal/satinised (65 % translucency), clear (85 % translucency), white/matt (translucency 75 %) or black matt (25 % translucency) is clicked into the ALU profile. The cover's wings cover the aluminium in the process. The profile is no longer visible.

The profile is placed behind the gypsum boards and can be considered a corner protection profile as it is the final element of the ceiling or wall drywall construction (Filling in and plastering possible). The gypsum boards are flush with the profile.

The result is sustainable indirect LED lighting!

Nachhaltige Licht-Integration in die Architektur

Diese innovativen LED Alu-Profile sind die perfekte Lösung für ganzheitliche Beleuchtungskonzepte im modernen Trockenbau. Lichtquelle und architektonisches Designelement in einem!

Das TBP4 LED Trockenbau-Profil wird standardmäßig in der Länge 200 cm geliefert und ist aus hochwertigem Aluminium (eloxiert) gefertigt. Es ist für LED Strips mit einer max. Breite von 14 mm konzipiert. Für eine homogene und blendfreie Lichtlinie wird die flache Standard-Profilabdeckung aus bruchsicherem und schwer brennbarem Polycarbonat (Klassifizierung Brennbarkeit UL94 V-2 - opal/satiniert (Lichtdurchlässigkeit 65 %), klar (Lichtdurchlässigkeit 85 %), weiß/matt (Lichtdurchlässigkeit 75 %) oder schwarz matt (Lichtdurchlässigkeit 25 %) in das ALU-Profil eingeklickt. Dabei bedecken die Flügel des Covers das Aluminium. Das Profil ist nicht mehr sichtbar.

Das Profil wird hinter den Gipsplatten angebracht und kann als Eckschutz-Profil angesehen werden, da es das abschließende Element der Decken- oder Wand-Trockenbaukonstruktion darstellt (Verspachteln und Verputzen möglich). Die Gipsplatten schließen bündig am Profil ab.

Das Resultat ist eine nachhaltige indirekte LED Beleuchtung!

GALAXY profiles
Perfect Light Lines

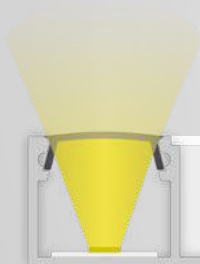

TBP4 + C32

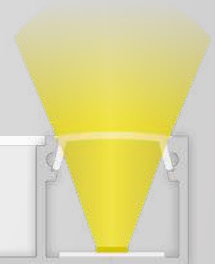

TBP4 + C2

GALAXY profiles
Perfect Light Lines

14,9 mm



max.
14 mm

OEM



COVERS | ABDECKUNGEN

C1 65 % 200cm 8600004 250 cm 8600026 300 cm 8600080 600 cm 8600037

C2 85 % 200 cm 8600003 250 cm 8600135 300 cm 8600136

C58 75 % 200 cm 8600154

C32 25 % 200 cm 8600070 300 cm 8600103 600 cm 8600071

END CAPS | ENDKAPPEN

E210 E210 81023011 **E211** E211 81023012

PROTECTIVE COVER | SCHUTZCOVER

C1S 500 cm 8600065

PROFILE

TBP4 200 cm 8102042 300 cm 8102142

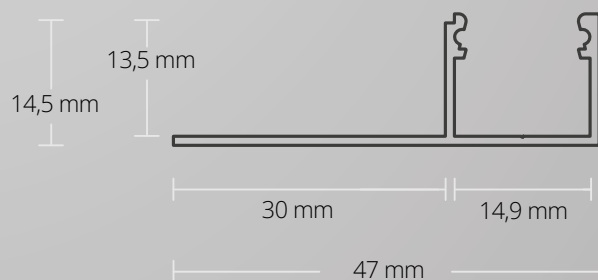

TBP4 DRYWALL | TROCKENBAU

LED Strips max. 14 mm
47 mm x 14,5 mm | 209 g/m

200 cm **8102042** 300 cm **8102142**

max.
14 mm

OEM



COVERS | ABDECKUNGEN



C1 opal | opal | 65 %

PC | 13,8 mm x 4,4 mm

200cm **8600004**

250cm **8600026**

300cm **8600080**

600cm **8600037**



C2 clear | klar | 85 %

PC | 13,8 mm x 4,4 mm

200cm **8600003**

250cm **8600135**

300cm **8600136**



C58 white/matt | weiß/matt | 75 %

PC | 13,8 mm x 4,4 mm

200cm **8600154**



C32 black/matt | schwarz/matt | 25 %

PC | 13,8 mm x 4,4 mm

200cm **8600070**

300cm **8600103**

600cm **8600071**

END CAPS | ENDKAPPEN



E210 PETG | 1 PCS/STK

E210 **81023011**



E211 PETG | 1 PCS/STK | Cable/Kabel

E211 **81023012**

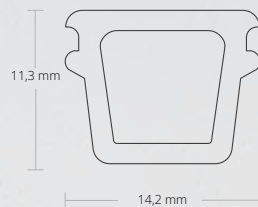

C1S Protective cover | Schutzcover

14,2 mm x 11,3 mm

500 cm **8600065**

The protective covers C1S and C10S soft are clicked into the aluminium profile for protection after the installation of drywall and tile profiles. The high-quality soft PVC is very robust and withstands the pressure of filling/plastering or painting. The protective cover prevents putty, glue, sealing material, silicone or paint from penetrating into the interior. Then the protective cover is removed, cleaned and is reusable several times over. Finally, the cover (PC) can be inserted into the profile.

Die Schutzcover C1S und C10S soft werden nach der Montage von Trockenbau- und Fliesenprofilen in das Alu-Profil zum Schutz eingeklickt. Das hochwertige Soft-PVC ist sehr robust und hält dem Druck beim Verspachteln/-putzen oder Streichen stand. Das Schutzcover verhindert, dass Spachtelmasse, Kleber, Dichtmaterial, Silikon oder Farbe in den Innenraum eindringt. Danach wird das Schutzcover abgenommen, gereinigt und ist vielfach wiederverwendbar. Abschließend kann die Abdeckung (PC) in das Profil eingesetzt werden.



TBP5

DRYWALL | TROCKENBAU

200 cm

max. 20 mm

OEM

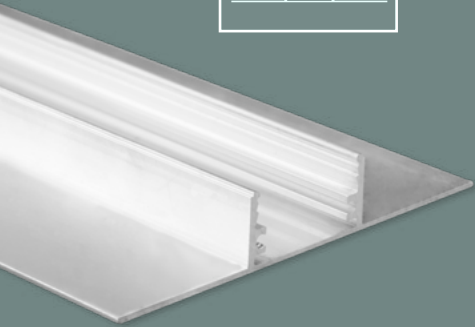

EXTENSION OF SERVICE LIFE
VERLÄNGERUNG LEBENSDAUER

MECHANICAL PROTECTION
MECHANISCHER SCHUTZ

COOLING
KÜHLUNG

HIGH LIGHT UTILISATION
HOHE LICHTVERWERTUNG

HOMOGENEOUS LIGHT
HOMOGENES LICHT

HOMOGENEOUS LIGHT with modular LED light solutions

- Homes
Wohnräume
- Offices, conference and presentation rooms
Büro-, Konferenz- und Präsentationsräume
- Waiting rooms
Ordinationen
- Business premises and sales floors
Geschäfts- und Verkaufsflächen
- Showrooms
- Hotel and gastronomy
Hotellerie und Gastronomie
- Foyers, corridors and connecting rooms
Foyers, Flure und Verbindungsräume
- Waiting and common rooms
Warte- und Aufenthaltsräume
- Commercial premises (e.g. hair salons)
Gewerbliche Dienstleistungsräumlichkeiten (z. B. Friseursalons etc.)

Mounting/installation on/in plasterboard
Montage/Einbau auf/in Gipsplatten

INSTALLATION INSTRUCTION
INSTALLATIONS MONTAGE



TBP5

DRYWALL | TROCKENBAU

LED Strips max. 20 mm

Silver/Silber
ANODIZED | ELOXIERT



max. 20 mm

max.
20 mm

OEM



Sustainable light integration into the architecture

These innovative LED aluminium profiles are the perfect solution for comprehensive lighting concepts in modern drywall construction. Light source and architectural design element in one!

The TBP5 LED drywall profile comes as standard in length of 200 cm and is made of high quality aluminium (anodised). It is designed for LED strips with a max. width of 20 mm. The low height of the profile significantly increases the beam angle of the bonded LED Strips. The large surface dissipates the heat of the LED chips excellently - thus strong strips can also be used. The profile is filled in or glued. The gypsum boards are mounted flush.

The wide range of profile covers made of shatter-proof and flame-retardant polycarbonate (UL94 V-2 classification for flammability) offers a wide range of homogeneous and glare-free light lines. Select from opal/satin (light transmission 65 %), frosted (75 %) and clear (85 %) profile covers in flat, round or high design and clicked into the ALU profile. At the same time the aluminium of the profile is covered. The profile is no longer visible.

The result is sustainable indirect LED lighting!

Nachhaltige Licht-Integration in die Architektur

Diese innovativen LED Alu-Profile sind die perfekte Lösung für ganzheitliche Beleuchtungskonzepte im modernen Trockenbau. Lichtquelle und architektonisches Designelement in einem!

Das TBP5 LED Trockenbau-Profil wird standardmäßig in der Länge 200 cm geliefert und ist aus hochwertigem Aluminium (eloxiert) gefertigt. Es ist für LED Strips mit einer max. Breite von 20 mm konzipiert. Die niedrige Höhe des Profils erhöht maßgeblich den Abstrahlwinkel der eingeklebten LED Strips. Die große Oberfläche leitet die Wärme der LED Chips ausgezeichnet ab – somit können auch starke Strips eingesetzt werden. Das Profil wird verspachtelt oder verklebt. Die Gipsplatten schließen bündig ab.

Variantenreiche homogene und blendfreie Lichtlinien bietet das große Sortiment an Profilabdeckungen aus bruchsicherem und schwer brennbarem Polycarbonat (Klassifizierung Brennbarkeit UL94 V-2). Wählbar sind opal/satinierte (Lichtdurchlässigkeit 65 %), frosted (75 %) und klare (85 %) Profilabdeckungen in flacher, runder oder hoher Ausführung und werden in das ALU-Profil eingeklickt. Dabei wird das Aluminium des Profils bedeckt. Das Profil ist nicht mehr sichtbar.

Das Resultat ist eine nachhaltige indirekte LED Beleuchtung!

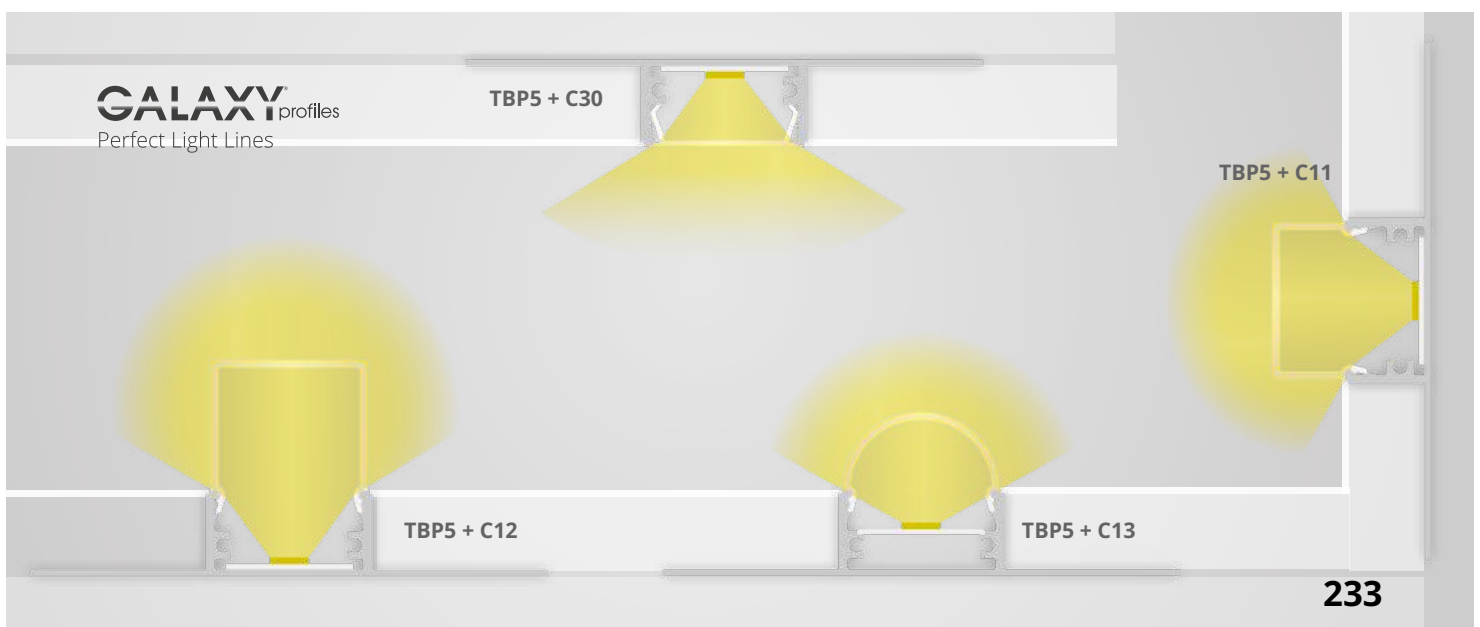

max.
20 mm

OEM



GALAXY profiles
Perfect Light Lines

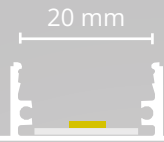

COVERS | ABDECKUNGEN

C30 65 % 200 cm 300 cm
8600077 8600081

C47 75 % 200 cm
8600099

C11 65 % 200 cm 300 cm
8600018 8600134

C35 85 % 200 cm
8600063

C12 65 % 200 cm
8600019

C31 85 % 200 cm
8600068

C13 65 % 200 cm
8600020

END CAPS | ENDKAPPEN

E43  E43 8201011  E43 8201015  E43 8201016

E212  E212 81023013 **E213**  E213 81023014

C30 **C47**

E44  E44 8202011  E44 8202012  E44 8202013

C11 **C35**

E45  E45 8203011  E45 8203012  E45 8203013

C12 **C31**

E46  E46 8204011  E46 8204012  E46 8204013

C13

PROTECTIVE COVER | SCHUTZCOVER

C10S  500 cm
8600066

PROFILE

TBP5  200 cm 8102043  300 cm 8102143

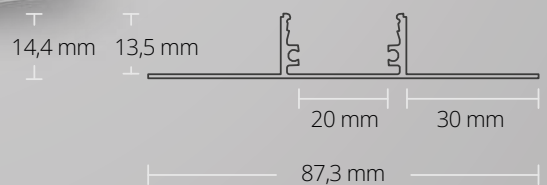

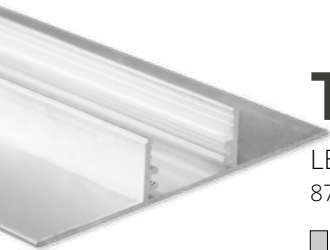

TBP5 DRYWALL | TROCKENBAU

LED Strips max. 20 mm
87,3 mm x 14,4 mm | 383 g/m

200 cm
8102043

300 cm
8102143

max.
20 mm



OEM



COVERS | ABDECKUNGEN

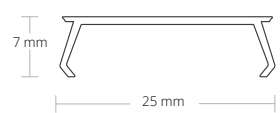

C30 opal | opal | 65 %
PC | 25mm x 7 mm
200cm 300cm
8600077 **8600081**

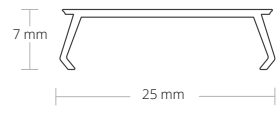

C47 weiß/matt | white/matt | 75 %
PC | 25mm x 7 mm
200cm
8600099

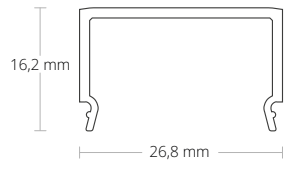

C11 opal | opal | 65 %
PC | 26,8 mm x 16,2 mm
200cm 300cm
8600018 **8600134**

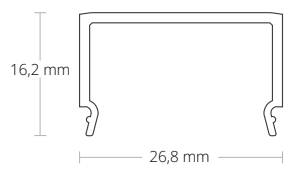

C35 clear | klar | 85 %
PC | 26,8 mm x 16,2 mm
200cm
8600063

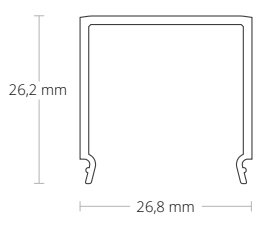

C12 opal | opal | 65 %
PC | 26,8 mm x 26,2 mm
200cm
8600019

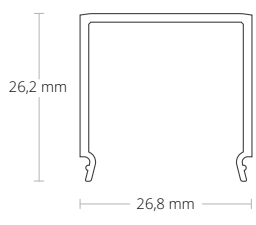

C31 clear | klar | 85 %
PC | 26,8 mm x 26,2 mm
200cm
8600068

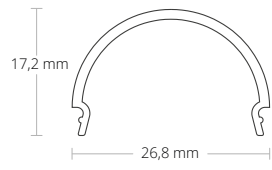

C13 opal | opal | 65 %
PC | 26,8 mm x 17,2 mm
200cm
8600020

max.
20 mm

OEM

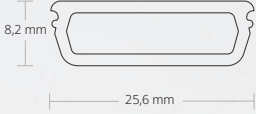
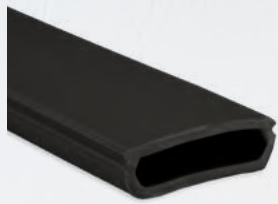
C10S Protective cover | Schutzcover

25,6 mm x 8,2 mm

500 cm
8600066

The protective covers C1S and C10S soft are clicked into the aluminium profile for protection after the installation of drywall and tile profiles. The high-quality soft PVC is very robust and withstands the pressure of filling/plastering or painting. The protective cover prevents putty, glue, sealing material, silicone or paint from penetrating into the interior. Then the protective cover is removed, cleaned and is reusable several times over. Finally, the cover (PC) can be inserted into the profile.

Die Schutzcover C1S und C10S soft werden nach der Montage von Trockenbau- und Fliesenprofilen in das Alu-Profil zum Schutz eingeklickt. Das hochwertige Soft-PVC ist sehr robust und hält dem Druck beim Verspachteln/-putzen oder Streichen stand. Das Schutzcover verhindert, dass Spachtelmasse, Kleber, Dichtmaterial, Silikon oder Farbe in den Innenraum eindringt. Danach wird das Schutzcover abgenommen, gereinigt und ist vielfach wiederverwendbar. Abschließend kann die Abdeckung (PC) in das Profil eingesetzt werden.



END CAPS | ENDKAPPEN



E212 PVC | 1 PCS/STK
C30 C47
E212
81023013



E213 PVC | 1 PCS/STK | Cable/Kabel
C30 C47
E213
81023014



E43 ALUMINIUM | 2 PCS/STK
C30 C47
incl. screws | inkl. Schraube
E43 E43 E43
8201011 8201015 8201016



E44 ALUMINIUM | 2 PCS/STK
C11 C35
incl. screws | inkl. Schraube
E44 E44 E44
8202011 8202012 8202013



E45 ALUMINIUM | 2 PCS/STK
C12 C31
incl. screws | inkl. Schraube
E45 E45 E45
8203011 8203012 8203013



E46 ALUMINIUM | 2 PCS/STK
C13
incl. screws | inkl. Schraube
E46 E46 E46
8204011 8204012 8204013

max.
20 mm



OEM



TBP6

DRYWALL | TROCKENBAU

200 cm | 300 cm

max. 14 mm

OEM

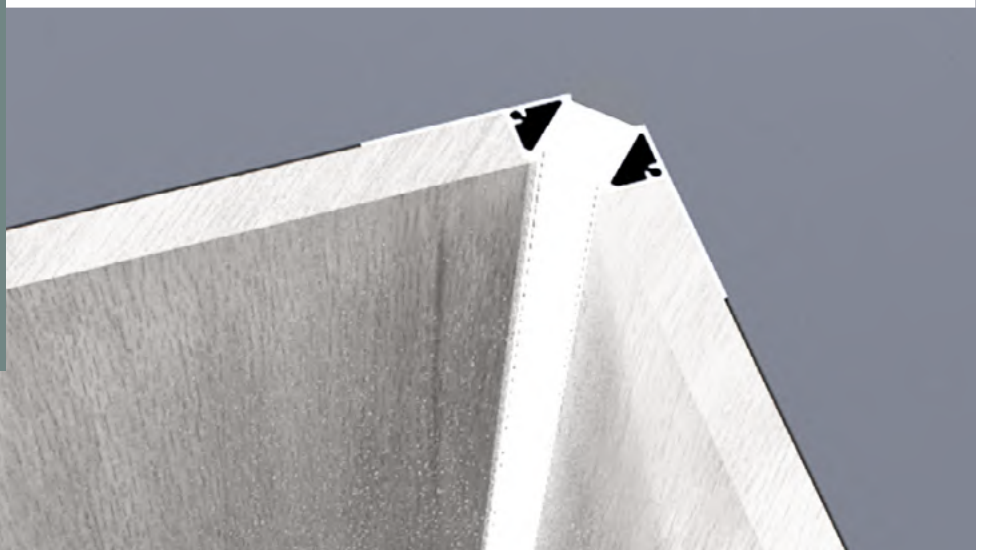
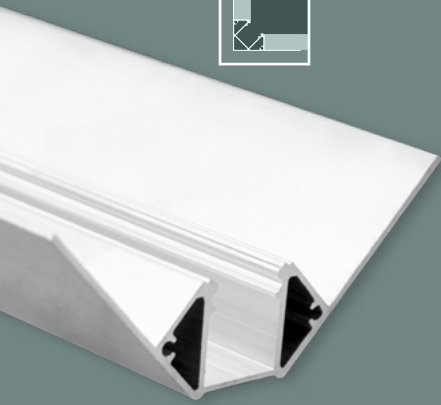

EXTENSION OF SERVICE LIFE
VERLÄNGERUNG LEBENSDAUER

MECHANICAL PROTECTION
MECHANISCHER SCHUTZ

COOLING
KÜHLUNG

HIGH LIGHT UTILISATION
HOHE LICHTVERWERTUNG

HOMOGENEOUS LIGHT
HOMOGENES LICHT

HOMOGENEOUS LIGHT with modular LED light solutions

- Homes
Wohnräume
- Offices, conference and presentation rooms
Büro-, Konferenz- und Präsentationsräume
- Waiting rooms
Ordinationen
- Business premises and sales floors
Geschäfts- und Verkaufsflächen
- Showrooms
- Hotel and gastronomy
Hotellerie und Gastronomie
- Foyers, corridors and connecting rooms
Foyers, Flure und Verbindungsräume
- Waiting and common rooms
Warte- und Aufenthaltsräume
- Commercial premises (e.g. hair salons)
Gewerbliche Dienstleistungsräumlichkeiten (z. B. Friseursalons etc.)

Mounting/installation on/in plasterboard
Montage/Einbau auf/in Gipsplatten

INSTALLATION INSTRUCTION
INSTALLATIONS MONTAGE



TBP6

DRYWALL | TROCKENBAU

LED Strips max. 14 mm

Silver/Silber
ANODIZED | ELOXIERT



max. 14 mm

max.
14 mm

OEM



Sustainable light integration into the architecture

These innovative LED aluminium profiles are the perfect solution for comprehensive lighting concepts in modern drywall construction. Light source and architectural design element in one!

The TBP6 LED drywall profile comes as standard in a length of 200 cm and is made of high quality aluminium (anodised). It is designed for LED strips with a max. width of 14 mm and is installed horizontally or vertically on the inside of corners. The profile has laterally 30 mm wide wings, which are filled in or glued under the plasterboard. The gypsum boards are mounted flush.

The profile covers are made of shatter-proof and flame-retardant polycarbonate (flammability classification UL94 V-2). Selectable: opal/satinised (65 % translucency), clear (85 % translucency), white/matt (translucency 75 %) or black matt (25 %). After clicking in the cover, the profile is no longer visible.

The result is sustainable indirect LED lighting!

Nachhaltige Licht-Integration in die Architektur

Diese innovativen LED Alu-Profile sind die perfekte Lösung für ganzheitliche Beleuchtungskonzepte im modernen Trockenbau. Lichtquelle und architektonisches Designelement in einem!

Das TBP6 LED Trockenbau-Profil wird standardmäßig in der Länge 200 cm geliefert und ist aus hochwertigem Aluminium (eloxiert) gefertigt. Es ist für LED Strips mit einer max. Breite von 14 mm konzipiert und wird horizontal oder vertikal auf der Innenseite von Ecken verbaut. Das Profil hat seitlich 30 mm breite Flügel, die unter den Gipsplatten verspachtelt oder verklebt werden. Die Gipsplatten schließen bündig ab.

Die Profilabdeckungen sind aus bruchsicherem und schwer brennbarem Polycarbonat (Klassifizierung Brennbarkeit UL94 V-2). Wählbar: opal/satiniert (Lichtdurchlässigkeit 65 %), klar (Lichtdurchlässigkeit 85 %), weiß/matt (Lichtdurchlässigkeit 75 %) oder schwarz matt (Lichtdurchlässigkeit 25 %). Nach dem Einklicken der Abdeckung ist das Profil nicht mehr sichtbar.

Das Resultat ist eine nachhaltige indirekte LED Beleuchtung!

GALAXY profiles
Perfect Light Lines

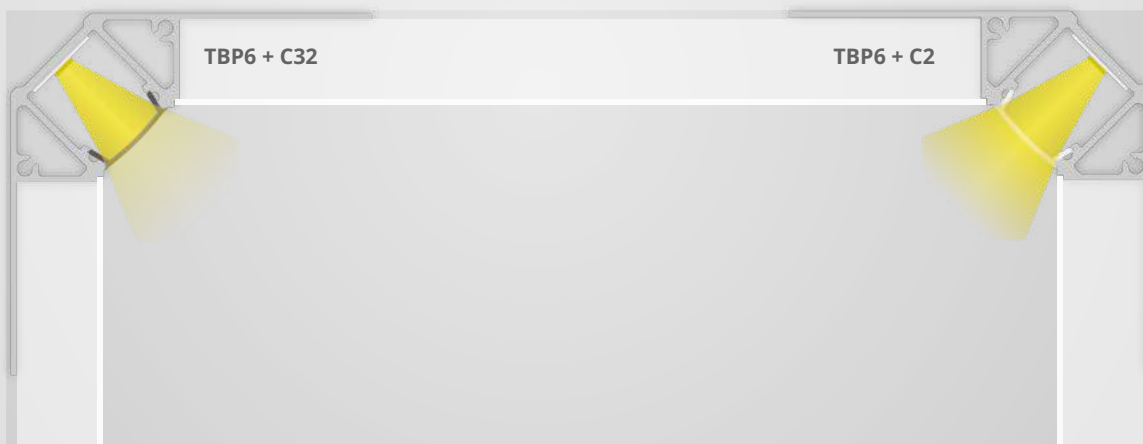

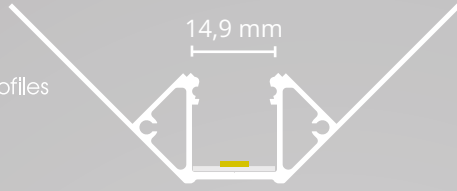

max.
14 mm

OEM



COVERS | ABDECKUNGEN

C1 65 % 200cm **8600004** 250 cm **8600026** 300 cm **8600080** 600 cm **8600037**

C2 85 % 200 cm **8600003** 250 cm **8600135** 300 cm **8600136**

C58 75 % 200 cm **8600154**

C32 25 % 200 cm **8600070** 300 cm **8600103** 600 cm **8600071**

END CAPS | ENDKAPPEN

E214 **E214** **81023015** **E215** **E215** **81023016**

PROTECTIVE COVER | SCHUTZCOVER

C1S 500 cm **8600065**

PROFILE

TBP6 200 cm **8102044** 300 cm **8102144**

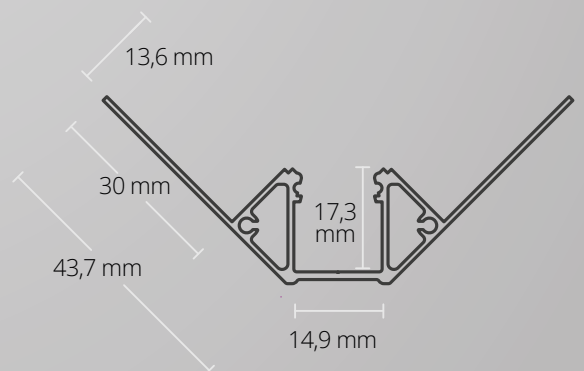



TBP6 DRYWALL | TROCKENBAU

LED Strips max. 14 mm
79,6 mm x 31,7 mm | 471 g/m

200 cm
8102044

300 cm
8102144

max.
14 mm

OEM

COVERS | ABDECKUNGEN



C1 opal | opal | 65 %

PC | 13,8 mm x 4,4 mm

200cm
8600004

250cm
8600026

300cm
8600080

600cm
8600037



C2 clear | klar | 85 %

PC | 13,8 mm x 4,4 mm

200cm
8600003

250cm
8600135

300cm
8600136



C58 white/matt | weiß/matt | 75 %

PC | 13,8 mm x 4,4 mm

200cm
8600154

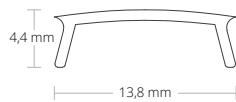

C32 black/matt | schwarz/matt | 25 %

PC | 13,8 mm x 4,4 mm

200cm
8600070

300cm
8600103

600cm
8600071

END CAPS | ENDKAPPEN



E214 PETG | 1 PCS/STK

E214
81023015



E215 PETG | 1 PCS/STK | Cable/Kabel

E215
81023016

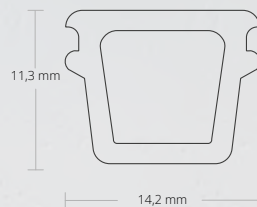

C1S Protective cover | Schutzcover

14,2 mm x 11,3 mm

500 cm
8600065

The protective covers C1S and C10S soft are clicked into the aluminium profile for protection after the installation of drywall and tile profiles. The high-quality soft PVC is very robust and withstands the pressure of filling/plastering or painting. The protective cover prevents putty, glue, sealing material, silicone or paint from penetrating into the interior. Then the protective cover is removed, cleaned and is reusable several times over. Finally, the cover (PC) can be inserted into the profile.

Die Schutzcover C1S und C10S soft werden nach der Montage von Trockenbau- und Fliesenprofilen in das Alu-Profil zum Schutz eingeklickt. Das hochwertige Soft-PVC ist sehr robust und hält dem Druck beim Verspachteln/-putzen oder Streichen stand. Das Schutzcover verhindert, dass Spachtelmasse, Kleber, Dichtmaterial, Silikon oder Farbe in den Innenraum eindringt. Danach wird das Schutzcover abgenommen, gereinigt und ist vielfach wiederverwendbar. Abschließend kann die Abdeckung (PC) in das Profil eingesetzt werden.



TBP7

DRYWALL | TROCKENBAU

200 cm | 300 cm

max. 12 mm

OEM



EXTENSION OF SERVICE LIFE
VERLÄNGERUNG LEBENSDAUER

MECHANICAL PROTECTION
MECHANISCHER SCHUTZ

COOLING
KÜHLUNG

HIGH LIGHT UTILISATION
HOHE LICHTVERWERTUNG

HOMOGENEOUS LIGHT
HOMOGENES LICHT

HOMOGENEOUS LIGHT with modular LED light solutions

- Homes
Wohnräume
- Offices, conference and presentation rooms
Büro-, Konferenz- und Präsentationsräume
- Waiting rooms
Ordinationen
- Business premises and sales floors
Geschäfts- und Verkaufsflächen
- Showrooms
- Hotel and gastronomy
Hotellerie und Gastronomie
- Foyers, corridors and connecting rooms
Foyers, Flure und Verbindungsräume
- Waiting and common rooms
Warte- und Aufenthaltsräume
- Commercial premises (e.g. hair salons)
Gewerbliche Dienstleistungsräumlichkeiten (z. B. Friseursalons etc.)

Mounting/installation on/in plasterboard
Montage/Einbau auf/in Gipsplatten

**INSTALLATION INSTRUCTION
INSTALLATIONS MONTAGE**

TBP7
DRYWALL



TBP7

DRYWALL | TROCKENBAU

LED Strips max. 12 mm

Silver/Silber
ANODIZED | ELOXIERT



max. 12 mm

max.
12 mm

OEM

Sustainable light integration into the architecture

These innovative LED aluminium profiles are the perfect solution for comprehensive lighting concepts in modern drywall construction. Light source and architectural design element in one!

The TBP7 LED drywall profile comes as standard in a length of 200 cm and 300 cm and is made of high quality aluminium (anodised). It is designed for LED strips with a max. width of 12 mm and is installed horizontally or vertically on the outside of corners. The profile has laterally 30 mm wide wings, which are filled in or glued under the plasterboard. The gypsum boards are mounted flush. Due to the generous internal dimensions, strong LEDs can also be used - homogeneity is maintained.

The profile covers are made of shatter-proof and flame-retardant polycarbonate (flammability classification UL94 V-2). Selectable: opal/satinised (65 % translucency), clear (85 % translucency), white/matt (75 % translucency) or black matt (25 % translucency). After clicking in the cover, the profile is no longer visible.

The result is sustainable indirect LED lighting!

Nachhaltige Licht-Integration in die Architektur

Diese innovativen LED Alu-Profile sind die perfekte Lösung für ganzheitliche Beleuchtungskonzepte im modernen Trockenbau. Lichtquelle und architektonisches Designelement in einem!

Das TBP7 LED Trockenbau-Profil wird standardmäßig in der Länge 200 cm und 300 cm geliefert und ist aus hochwertigem Aluminium (eloxiert) gefertigt. Es ist für LED Strips mit einer max. Breite von 12 mm konzipiert und wird horizontal oder vertikal auf der Außenseite von Ecken verbaut. Das Profil hat seitlich 30 mm breite Flügel, die unter die Gipsplatten verspachtelt oder verklebt werden. Die Gipsplatten schließen bündig ab. Aufgrund des großzügigen Innenmaßes können auch starke LEDs eingesetzt werden – die Homogenität bleibt erhalten.

Die Profilabdeckungen sind aus bruchsicherem und schwer brennbarem Polycarbonat (Klassifizierung Brennbarkeit UL94 V-2). Wählbar: opal/satiniert (Lichtdurchlässigkeit 65 %), klar (Lichtdurchlässigkeit 85 %), weiß/matt (Lichtdurchlässigkeit 75 %) oder schwarz matt (Lichtdurchlässigkeit 25 %). Nach dem Einklicken der Abdeckung ist das Profil nicht mehr sichtbar.

Das Resultat ist eine nachhaltige indirekte LED Beleuchtung!

GALAXY profiles
Perfect Light Lines

TBP7 + C32

TBP7 + C2

- max. 12 mm
- OEM
- Water drop icon

GALAXY profiles
Perfect Light Lines

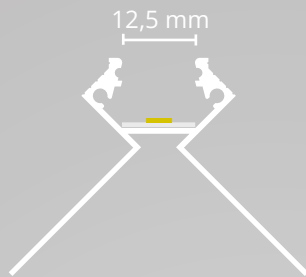

C1 E216 E217^K

C2 E216 E217^K

C58 E216 E217^K

C32 E216 E217^K

TBP7

COVERS | ABDECKUNGEN

C1 65 %	200cm 8600004	250 cm 8600026	300 cm 8600080	600 cm 8600037
C2 85 %	200 cm 8600003	250 cm 8600135	300 cm 8600136	
C58 75 %	200 cm 8600154			
C32 25 %	200 cm 8600070	300 cm 8600103	600 cm 8600071	

END CAPS | ENDKAPPEN

E216 E216 81023017 **E217** E217 81023018

PROTECTIVE COVER | SCHUTZCOVER

C1S 500 cm 8600065

PROFILE

TBP7 200 cm 8102045 300 cm 8102145

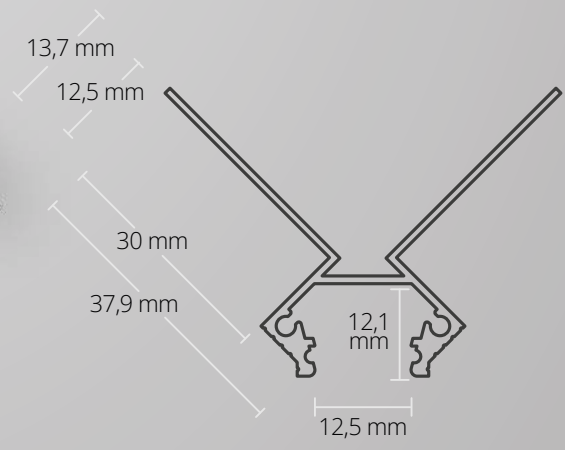

TBP7 DRYWALL | TROCKENBAU

LED Strips max. 12 mm
37,9 mm x 13,7 mm | 344 g/m

200 cm
8102045

300 cm
8102145

max.
12 mm

OEM



COVERS | ABDECKUNGEN



C1 opal | opal | 65 %

PC | 13,8 mm x 4,4 mm

200cm
8600004

250cm
8600026

300cm
8600080

600cm
8600037



C2 clear | klar | 85 %

PC | 13,8 mm x 4,4 mm

200cm
8600003

250cm
8600135

300cm
8600136



C58 white/matt | weiß/matt | 75 %

PC | 13,8 mm x 4,4 mm

200cm
8600154

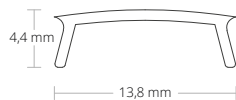

C32 black/matt | schwarz/matt | 25 %

PC | 13,8 mm x 4,4 mm

200cm
8600070

300cm
8600103

600cm
8600071

END CAPS | ENDKAPPEN



E216 PETG | 1 PCS/STK

E216
81023017



E217 PETG | 1 PCS/STK | Cable/Kabel

E217
81023018

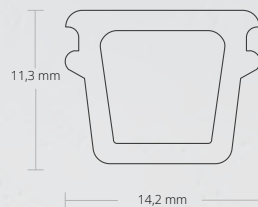

C1S Protective cover | Schutzcover

14,2 mm x 11,3 mm

500 cm
8600065

The protective covers C1S and C10S soft are clicked into the aluminium profile for protection after the installation of drywall and tile profiles. The high-quality soft PVC is very robust and withstands the pressure of filling/plastering or painting. The protective cover prevents putty, glue, sealing material, silicone or paint from penetrating into the interior. Then the protective cover is removed, cleaned and is reusable several times over. Finally, the cover (PC) can be inserted into the profile.

Die Schutzcover C1S und C10S soft werden nach der Montage von Trockenbau- und Fliesenprofilen in das Alu-Profil zum Schutz eingeklickt. Das hochwertige Soft-PVC ist sehr robust und hält dem Druck beim Verspachteln/-putzen oder Streichen stand. Das Schutzcover verhindert, dass Spachtelmasse, Kleber, Dichtmaterial, Silikon oder Farbe in den Innenraum eindringt. Danach wird das Schutzcover abgenommen, gereinigt und ist vielfach wiederverwendbar. Abschließend kann die Abdeckung (PC) in das Profil eingesetzt werden.



TBP10

DRYWALL | TROCKENBAU

200 cm

max. 11 mm

OEM

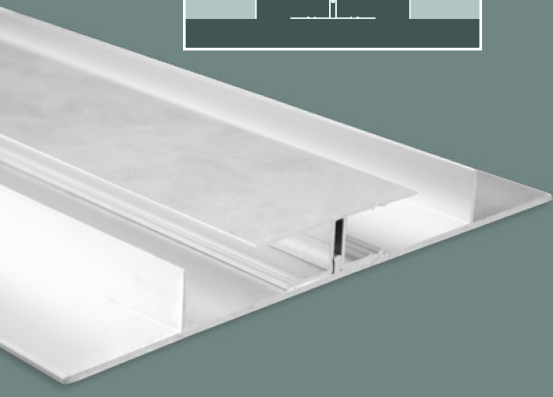

EXTENSION OF SERVICE LIFE
VERLÄNGERUNG LEBENSDAUER

MECHANICAL PROTECTION
MECHANISCHER SCHUTZ

COOLING
KÜHLUNG

HIGH LIGHT UTILISATION
HOHE LICHTVERWERTUNG

HOMOGENEOUS LIGHT
HOMOGENES LICHT

HOMOGENEOUS LIGHT with modular LED light solutions

- Homes
Wohnräume
- Offices, conference and presentation rooms
Büro-, Konferenz- und Präsentationsräume
- Waiting rooms
Ordinationen
- Business premises and sales floors
Geschäfts- und Verkaufsflächen
- Showrooms
- Hotel and gastronomy
Hotellerie und Gastronomie
- Foyers, corridors and connecting rooms
Foyers, Flure und Verbindungsräume
- Waiting and common rooms
Warte- und Aufenthaltsräume
- Commercial premises (e.g. hair salons)
Gewerbliche Dienstleistungsräumlichkeiten (z. B. Friseursalons etc.)

Mounting/installation on/in plasterboard
Montage/Einbau auf/in Gipsplatten



INSTALLATION INSTRUCTION
INSTALLATIONS MONTAGE







TBP10

DRYWALL | TROCKENBAU

LED Strips max. 11 mm

Silver/Silber
ANODIZED | ELOXIERT



max. 11 mm



Sustainable light integration into the architecture

These innovative LED aluminium profiles are the perfect solution for comprehensive lighting concepts in modern drywall construction. Light source and architectural design element in one!

The TBP10 LED drywall profile system consists of two light components (base plate and luminaire module) and is supplied as standard in a length of 200 cm. The lighting components are made of high-quality aluminium (anodised) (also available in black / RAL9005 and white / RAL9003 - powder-coated). The central luminaire module is designed for LED strips on both sides (lateral radiation), each with a max. width of 11 mm.

Laterally, the base plate has 30 mm wide wings, which are connected to the gypsum boards. The luminaire module is inserted into the base plate.

The profile cover (opal/satin - light transmission 65 %) is made of shatter-proof and flame-retardant polycarbonate (flammability classification UL94 V-2).

The result is sustainable indirect LED lighting!

Nachhaltige Licht-Integration in die Architektur

Diese innovativen LED Alu-Profile sind die perfekte Lösung für ganzheitliche Beleuchtungskonzepte im modernen Trockenbau. Lichtquelle und architektonisches Designelement in einem!

Das TBP10 LED Trockenbau-Profilsystem besteht aus zwei Lichtbauelementen (Grundplatte und Leuchtenmodul) und wird standardmäßig in der Länge 200 cm geliefert. Die Lichtbauelemente sind aus hochwertigem Aluminium (eloxiert) gefertigt. Das zentrale Leuchtenmodul ist beidseitig (seitliche Abstrahlung) für LED Strips mit je einer max. Breite von 11 mm konzipiert.

Die Grundplatte hat seitlich 30 mm breite Flügel, die mit den Gipsplatten verbunden werden. Das Leuchtenmodul wird in die Grundplatte gesteckt.

Die Profilabdeckung (opal/satiniert - Lichtdurchlässigkeit 65 %) ist aus bruchsicherem und schwer brennbarem Polycarbonat (Klassifizierung Brennbarkeit UL94 V-2).

Das Resultat ist eine nachhaltige indirekte LED Beleuchtung!

GALAXY profiles
Perfect Light Lines

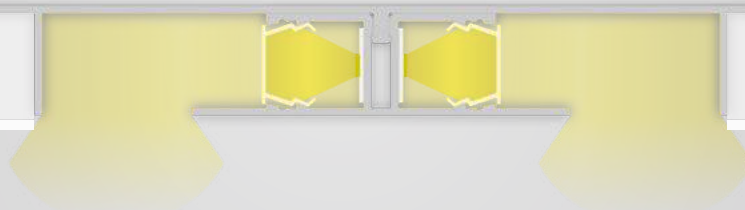

TBP10 + TBP8 + C27 + C27

max.
11 mm

OEM

GALAXY profiles
Perfect Light Lines



COVERS | ABDECKUNGEN

C27 65 % 200cm 8600084 300cm 8600113

PROFILE

TBP10 200 cm 8102047

TBP8 200 cm 8102046

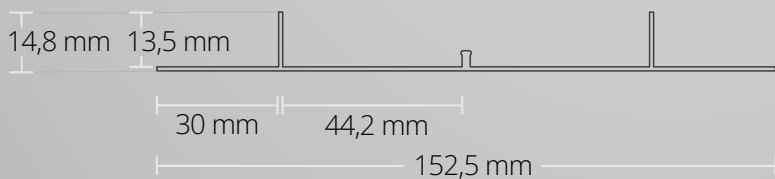
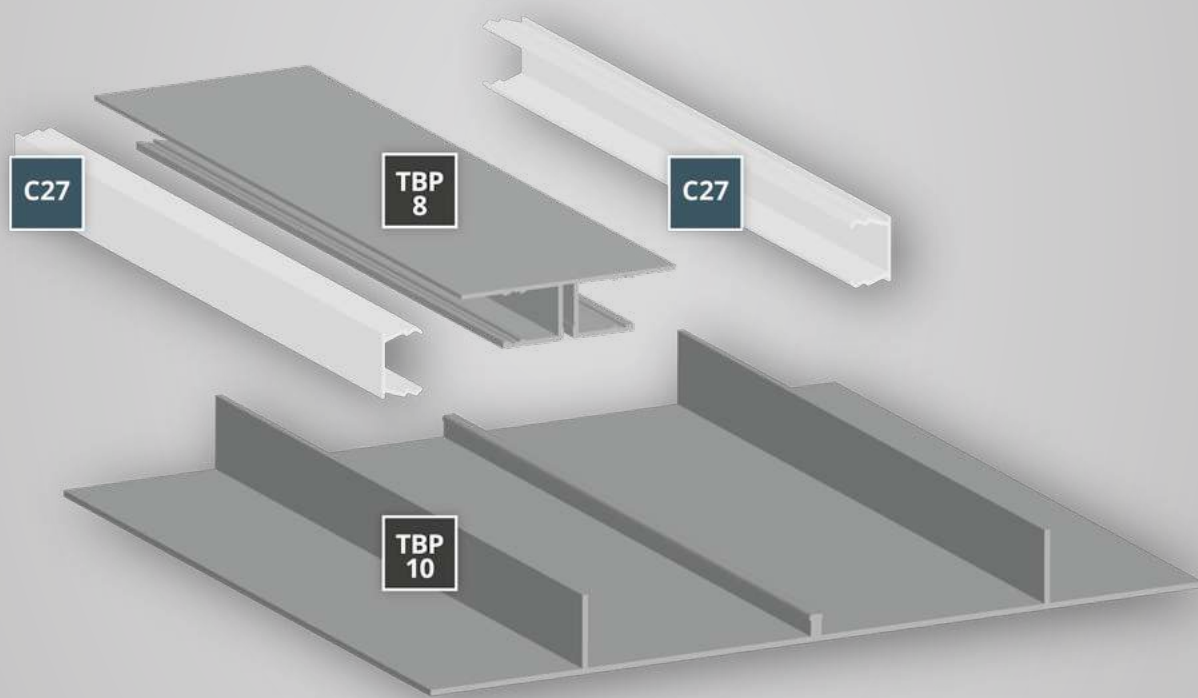

TBP10

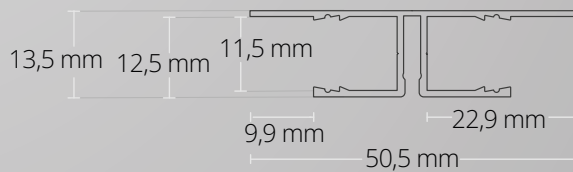

TBP8

TBP10 DRYWALL | TROCKENBAU

LED Strips max. 11 mm

TBP 10 152,5 mm x 14,8 mm | 716 g/m

TBP 8 50,5 mm x 13,5 mm | 273 g/m



TBP10

200 cm
8102047

TBP8

200 cm
8102046

max.
11 mm

OEM



COVERS | ABDECKUNGEN

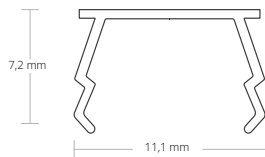

C27 opal | opal | 65 %

PC | 11,1 mm x 7,2 mm

200cm 300cm
8600084 **8600113**

TBP11

DRYWALL | TROCKENBAU

200 cm

max. 11 mm

OEM

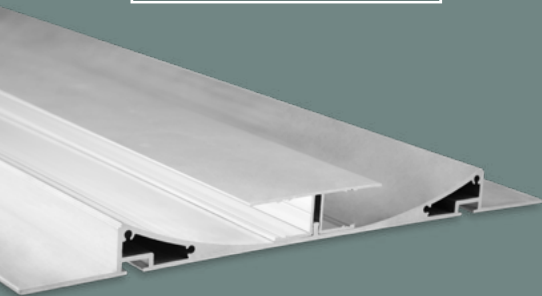

EXTENSION OF SERVICE LIFE
VERLÄNGERUNG LEBENSDAUER

MECHANICAL PROTECTION
MECHANISCHER SCHUTZ

COOLING
KÜHLUNG

HIGH LIGHT UTILISATION
HOHE LICHTVERWERTUNG



HOMOGENEOUS LIGHT
HOMOGENES LICHT

HOMOGENEOUS LIGHT with modular LED light solutions

- Homes
Wohnräume
- Offices, conference and presentation rooms
Büro-, Konferenz- und Präsentationsräume
- Waiting rooms
Ordinationen
- Business premises and sales floors
Geschäfts- und Verkaufsflächen
- Showrooms
- Hotel and gastronomy
Hotellerie und Gastronomie
- Foyers, corridors and connecting rooms
Foyers, Flure und Verbindungsräume
- Waiting and common rooms
Warte- und Aufenthaltsräume
- Commercial premises (e.g. hair salons)
Gewerbliche Dienstleistungsräumlichkeiten (z. B. Friseursalons etc.)

Mounting/installation on/in plasterboard
Montage/Einbau auf/in Gipsplatten

INSTALLATION INSTRUCTION
INSTALLATIONS MONTAGE





TBP11

DRYWALL | TROCKENBAU

LED Strips max. 11 mm

Silver/Silber
ANODIZED | ELOXIERT

RAL 9003 White/Weiß
POWDER-COATED | PULVERBESCHICHTET

RAL 9005 Black/Schwarz
POWDER-COATED | PULVERBESCHICHTET

max.
11 mm

OEM



max. 11 mm

Sustainable light integration into the architecture

These innovative LED aluminium profiles are the perfect solution for comprehensive lighting concepts in modern drywall construction. Light source and architectural design element in one!

The TBP11 LED drywall profile system consists of two light components (base plate and luminaire module) and is supplied as standard in a length of 200 cm. The lighting components are made of high-quality aluminium (anodized) (also available in black / white - powder-coated). The central luminaire module is designed for LED strips on both sides (lateral radiation), each with a max. width of 11 mm.

Laterally, the base plate has 30 mm wide wings, which are connected to the gypsum boards. The luminaire module is inserted into the base plate.

The profile cover (opal/satin - light transmission 65 %) is made of shatter-proof and flame-retardant polycarbonate (flammability classification UL94 V-2).

The result is sustainable indirect LED lighting!

Nachhaltige Licht-Integration in die Architektur

Diese innovativen LED Alu-Profile sind die perfekte Lösung für ganzheitliche Beleuchtungskonzepte im modernen Trockenbau. Lichtquelle und architektonisches Designelement in einem!

Das TBP11 LED Trockenbau-Profilsystem besteht aus zwei Lichtbauelementen (Grundplatte und Leuchtenmodul) und wird standardmäßig in der Länge 200 cm geliefert. Die Lichtbauelemente sind aus hochwertigem Aluminium (eloxiert) gefertigt (auch in Schwarz/Weiß verfügbar - pulverbeschichtet). Das zentrale Leuchtenmodul ist beidseitig (seitliche Abstrahlung) für LED Strips mit je einer max. Breite von 11 mm konzipiert.

Die Grundplatte hat seitlich 30 mm breite Flügel, die mit den Gipsplatten verbunden werden. Das Leuchtenmodul wird in die Grundplatte gesteckt.

Die Profilabdeckung (opal/satiniert - Lichtdurchlässigkeit 65 %) ist aus bruchsicherem und schwer brennbarem Polycarbonat (Klassifizierung Brennbarkeit UL94 V-2).

Das Resultat ist eine nachhaltige indirekte LED Beleuchtung!

GALAXY profiles
Perfect Light Lines

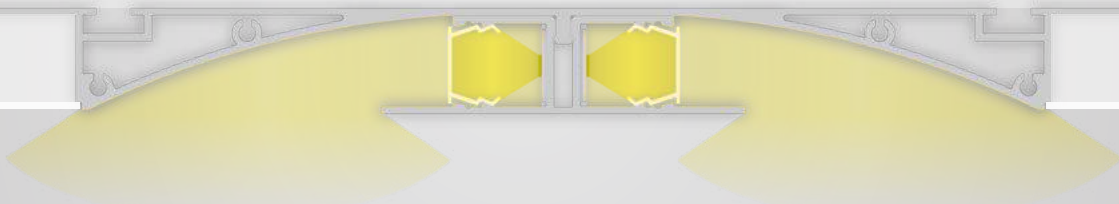

TBP11 + TBP8 + C27 + C27

max.
11 mm

OEM



GALAXY profiles
Perfect Light Lines



COVERS | ABDECKUNGEN

C27 65 % 200cm 300cm
8600084 8600113

PROFILE

TBP11 200 cm 200 cm 200cm
8102048 8103048 8102054

TBP8 200 cm 200 cm 200cm
8102046 8103046 8102052

 Z10
8301504

 Z11
8301505

 Z53
8123401

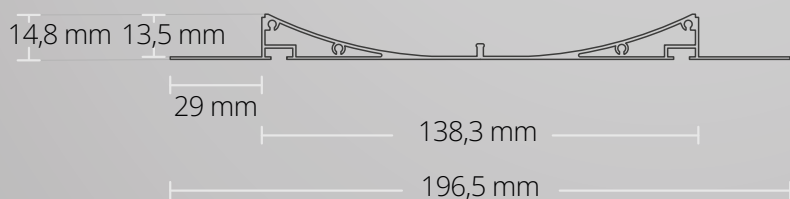
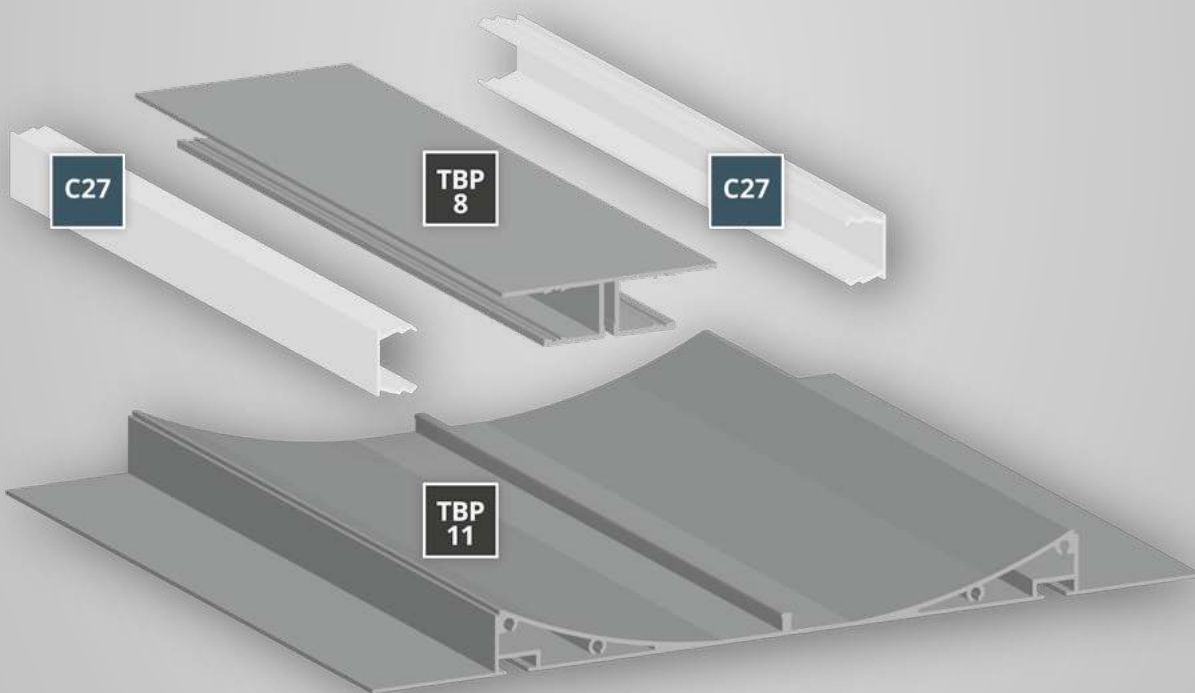

TBP11



TBP8

TBP11 DRYWALL | TROCKENBAU

LED Strips max. 11 mm

TBP 11 96,5 mm x 14,8 mm | 1545 g/m

TBP 8 50,5 mm x 13,5 mm | 273 g/m



TBP11

200 cm
8102048

200 cm
8103048

200 cm
8102054

TBP8

200 cm
8102046

200 cm
8103046

200 cm
8102052



Z10 | Z11

Connector | Verbinder
Steel | Stahl | 4 PCS/STK

Z10 | 180° **8301504**

Z11 | 90° **8301505**



Z53

Connector | Verbinder
flexibel 180°- 45°

2PCS/STK | Steel | Stahl

8123401



COVERS | ABDECKUNGEN

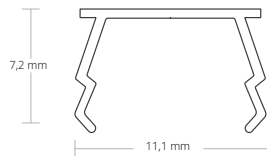

C27 opal | opal | 65 %

PC | 11,1 mm x 7,2 mm

200cm 300cm

8600084 8600113

max.
11 mm

OEM



TBP12

DRYWALL | TROCKENBAU

200 cm

max. 11 mm

OEM



EXTENSION OF SERVICE LIFE
VERLÄNGERUNG LEBENSDAUER

MECHANICAL PROTECTION
MECHANISCHER SCHUTZ

COOLING
KÜHLUNG

HIGH LIGHT UTILISATION
HOHE LICHTVERWERTUNG

HOMOGENEOUS LIGHT
HOMOGENES LICHT

HOMOGENEOUS LIGHT with modular LED light solutions

- Homes
Wohnräume
- Offices, conference and presentation rooms
Büro-, Konferenz- und Präsentationsräume
- Waiting rooms
Ordinationen
- Business premises and sales floors
Geschäfts- und Verkaufsflächen
- Showrooms
- Hotel and gastronomy
Hotellerie und Gastronomie
- Foyers, corridors and connecting rooms
Foyers, Flure und Verbindungsräume
- Waiting and common rooms
Warte- und Aufenthaltsräume
- Commercial premises (e.g. hair salons)
Gewerbliche Dienstleistungsräumlichkeiten (z. B. Friseursalons etc.)

Mounting/installation on/in plasterboard
Montage/Einbau auf/in Gipsplatten

INSTALLATION INSTRUCTION
INSTALLATIONS MONTAGE



TBP12

DRYWALL | TROCKENBAU

LED Strips max. 11 mm

 Silver/Silber
ANODIZED | ELOXIERT

 RAL 9003 White/Weiß
POWDER-COATED | PULVERBESCHICHTET

 RAL 9005 Black/Schwarz
POWDER-COATED | PULVERBESCHICHTET

max.
11 mm

OEM



max. 11 mm

Sustainable light integration into the architecture

These innovative LED aluminium profiles are the perfect solution for comprehensive lighting concepts in modern drywall construction. Light source and architectural design element in one!

The TBP12 LED drywall profile system is a full-featured luminaire module and comes as standard with a length of 200 cm. It is made of high-quality aluminium (anodised) (also available in black / white - powder-coated) and can be equipped with LED strips with a max. width of 11 mm.

The side wings (30 mm wide) are connected to the plasterboard (glued / filled in). The profile cover (opal/satin - light transmission 65 %) is made of shatter-proof and flame-retardant polycarbonate (flammability classification UL94 V-2) - available in 200 cm and 300 cm length.

The result is sustainable indirect LED lighting!

Nachhaltige Licht-Integration in die Architektur

Diese innovativen LED Alu-Profile sind die perfekte Lösung für ganzheitliche Beleuchtungskonzepte im modernen Trockenbau. Lichtquelle und architektonisches Designelement in einem!

Das TBP12 LED Trockenbau-Profilssystem ist ein vollwertiges Leuchtenmodul und wird standardmäßig in der Länge 200 cm geliefert. Es wird aus hochwertigem Aluminium (eloxiert) gefertigt (auch in Schwarz/Weiß verfügbar - pulverbeschichtet) und kann mit LED Strips mit max. Breite von 11 mm bestückt werden.

Die seitlichen Flügel (30 mm breit) werden mit den Gipsplatten verbunden (verklebt/verspachtelt). Die Profilverabdeckung (opal/satiniert - Lichtdurchlässigkeit 65 %) ist aus bruchsicherem und schwer brennbarem Polycarbonat (Klassifizierung Brennbarkeit UL94 V-2) - verfügbar mit 200 cm und 300 cm Länge.

Das Resultat ist eine nachhaltige indirekte LED Beleuchtung!

GALAXY profiles
Perfect Light Lines



TBP12 + C27

max.
11 mm

OEM



GALAXY profiles
Perfect Light Lines



COVERS | ABDECKUNGEN

C27 65 % 200cm 300cm
8600084 8600113

PROFILE

TBP12 200 cm 200 cm 200cm
8102049 8103049 8102055

 Z10
8301504

 Z11
8301505

 Z53
8123401

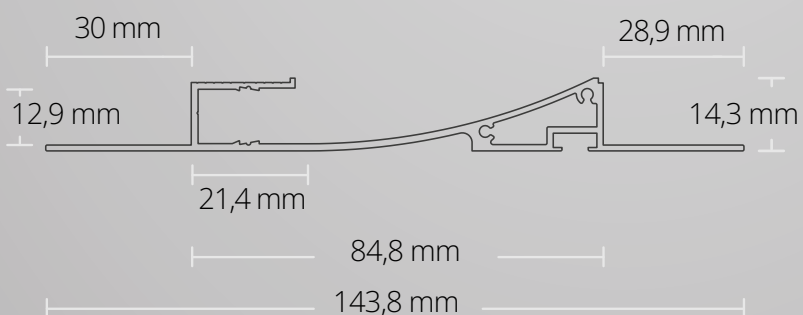



TBP12 DRYWALL | TROCKENBAU

LED Strips max. 11 mm

143,8 mm x 14,3 mm | 990 g/m

200 cm
8102049

200 cm
8103049

200 cm
8102055



Z10 | Z11

Connector | Verbinder
Steel | Stahl | 4 PCS/STK

Z10 | 180° **8301504**
Z11 | 90° **8301505**



Z53

Connector | Verbinder
flexibel 180°- 45°
2PCS/STK | Steel | Stahl

8123401



max.
11 mm



OEM



COVERS | ABDECKUNGEN

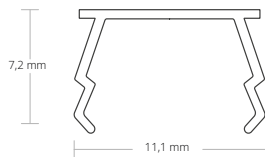

C27 opal | opal | 65 %

PC | 11,1 mm x 7,2 mm

200cm

300cm

8600084

8600113

TBP13

DRYWALL | TROCKENBAU

200 cm | 300 cm

max. 21 mm

OEM

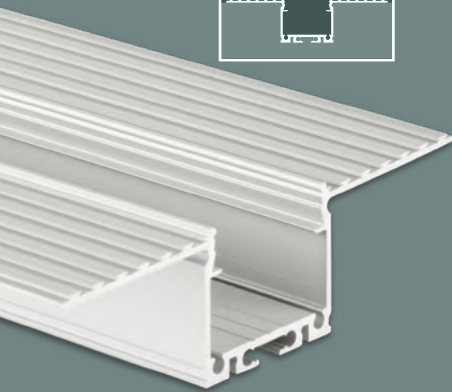
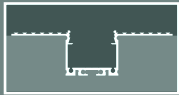

EXTENSION OF SERVICE LIFE
VERLÄNGERUNG LEBENSDAUER

MECHANICAL PROTECTION
MECHANISCHER SCHUTZ

COOLING
KÜHLUNG

HIGH LIGHT UTILISATION
HOHE LICHTVERWERTUNG

HOMOGENEOUS LIGHT
HOMOGENES LICHT

HOMOGENEOUS LIGHT with modular LED light solutions

- Homes
Wohnräume
- Offices, conference and presentation rooms
Büro-, Konferenz- und Präsentationsräume
- Waiting rooms
Ordinationen
- Business premises and sales floors
Geschäfts- und Verkaufsflächen
- Showrooms
- Hotel and gastronomy
Hotellerie und Gastronomie
- Foyers, corridors and connecting rooms
Foyers, Flure und Verbindungsräume
- Waiting and common rooms
Warte- und Aufenthaltsräume
- Commercial premises (e.g. hair salons)
Gewerbliche Dienstleistungsräumlichkeiten (z. B. Friseursalons etc.)

Mounting/installation on/in wood Strips and plates, plasterboard, tiles, stone, granite, marble and metal surfaces
Montage/Einbau auf/in Holzleisten und -platten, Gipsplatten, Fliesen, Stein-, Granit-, Marmor- und Metalloberflächen



TBP13

DRYWALL | TROCKENBAU

with plastered surfaces | mit Verputzfläche | LED Strips max. 21 mm

Silver/Silber
ANODIZED | ELOXIERT



max. 21 mm

max.
21 mm

OEM



The TBP13 LED Drywall Profile with plastered surfaces is 200cm long as standard and is made from high-quality aluminium (anodised). This profile is designed for especially high-performance LED flex strips predominantly for general room lighting.

One or more flex strips can be fixed to the profile with adhesive - max width 21mm. This allows countless light scenarios to suit your needs. The profile's large surface area means heat dissipates excellently.

This LED profile cover (opal/satinised - 65 % transparency) is made from shatterproof, flame-retardant polycarbonate (classification flammability UL94 V-2), provides a flush finish on the inside and ensures a uniform LED light with high transfer of the light output.

The TBP13 LED RECESSED Profile with plastered surfaces is placed/glued into recesses in the wall. The wings on the front can be plastered over. This means that only the line of light is visible.

Das TBP13 LED Trockenbau-Profil mit Verputzfläche hat eine Standardlänge von 200 cm und wird aus qualitativ hochwertigem Aluminium (eloxiert) gefertigt. Das Profil ist für besonders leistungsstarke LED Flexbänder vorgesehen und somit vor allem für die allgemeine Raumbeleuchtung konzipiert.

Das Profil kann mit einem oder mit mehreren Flexbändern beklebt werden – max. Gesamtbreite 21 mm. Dies ermöglicht unzählige an die Anforderungen angepasste Lichtszenarien. Die große Oberfläche des Profils leitet die entstehende Wärme ausgezeichnet ab.

Die LED Profilabdeckung (opal/satiniert - Lichtdurchlässigkeit 65 %) besteht aus bruchsicherem und schwer brennbarem Polycarbonat (Klassifizierung Brennbarkeit UL94 V-2), schließt innenseitig bündig ab und schafft homogene LED Lichtverhältnisse mit hoher Verwertung der Lichtleistung.

Das TBP13 LED EINBAU-Profil mit Verputzfläche wird in die Aussparung des Mauerwerks eingelegt/eingeklebt. Die auf der Vorderseite liegenden Flügel können verputzt werden. Als Ergebnis ist nur die Lichtlinie sichtbar.

GALAXY profiles
Perfect Light Lines

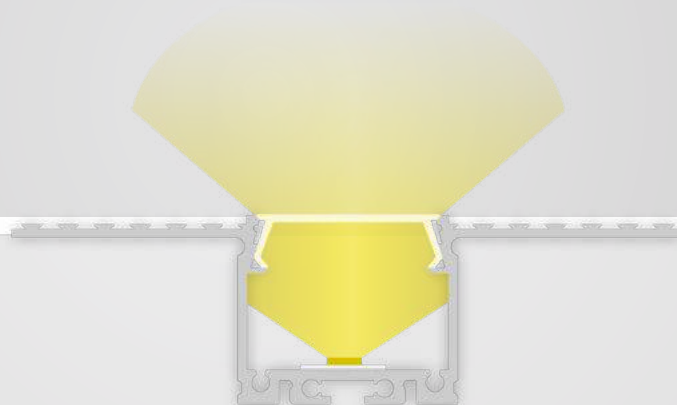

TBP13 + C30

max.
21 mm

OEM



GALAXY profiles
Perfect Light Lines

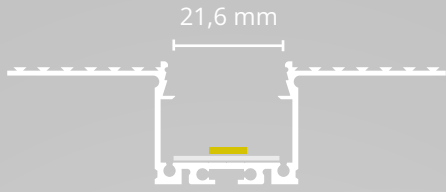

COVERS | ABDECKUNGEN

C30 65 %	200 cm 8600077	300 cm 8600081
C47 75 %	200 cm 8600099	
C11 65 %	200 cm 8600018	300 cm 8600134
C35 85 %	200 cm 8600063	
C12 65 %	200 cm 8600019	
C31 85 %	200 cm 8600068	
C13 65 %	200 cm 8600020	

PROTECTIVE COVER | SCHUTZCOVER

C10S	500 cm 8600066
-------------	-------------------

PROFILE

TBP13	200 cm 8103090	300 cm 8103190
	Z22 8301508	Z23 8301509

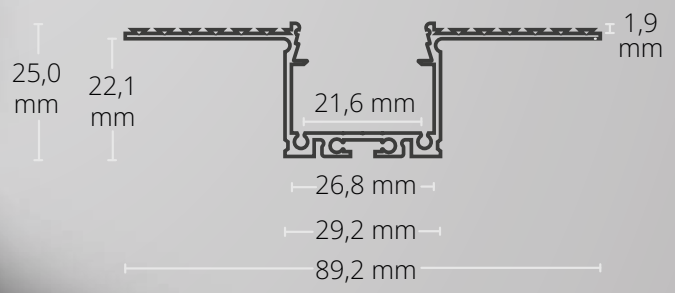



TBP13 DRYWALL | TROCKENBAU

LED Strips max. 21 mm
89,2 mm x 25 mm | 544 g/m

200 cm
8103090

300 cm
8103190



Z22 | Z23

Connector | Verbinder
Steel | Stahl | 4 PCS/STK

Z22 | 180° **8301508**

Z23 | 90° **8301509**

max.
21 mm

OEM



COVERS | ABDECKUNGEN

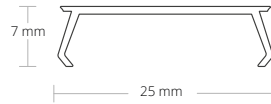

C30 opal | opal | 65 %

PC | 25mm x 7 mm

200cm

8600077

300cm

8600081

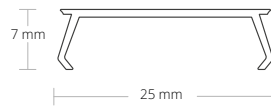

C47 weiß/matt | white/matt | 75 %

PC | 25mm x 7 mm

200cm

8600099

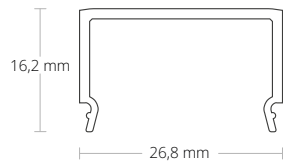

C11 opal | opal | 65 %

PC | 26,8 mm x 16,2 mm

200cm

8600018

300cm

8600134

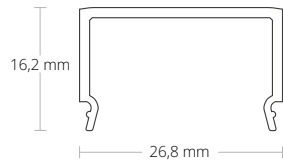

C35 clear | klar | 85 %

PC | 26,8 mm x 16,2 mm

200cm

8600063

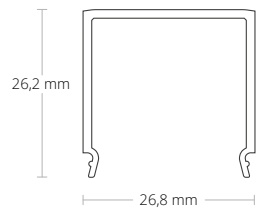

C12 opal | opal | 65 %

PC | 26,8 mm x 26,2 mm

200cm

8600019

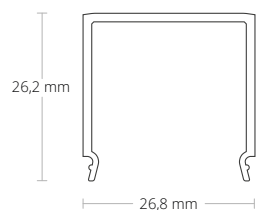

C31 clear | klar | 85 %

PC | 26,8 mm x 26,2 mm

200cm

8600068

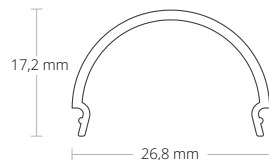

C13 opal | opal | 65 %

PC | 26,8 mm x 17,2 mm

200cm

8600020

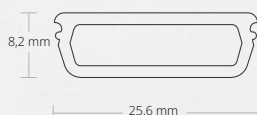
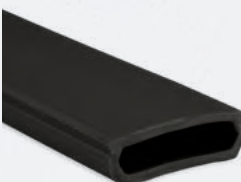

C10S Protective cover | Schutzcover

25,6 mm x 8,2 mm

500 cm

8600066



TBP14

DRYWALL | TROCKENBAU

200 cm

max. 12 mm

OEM

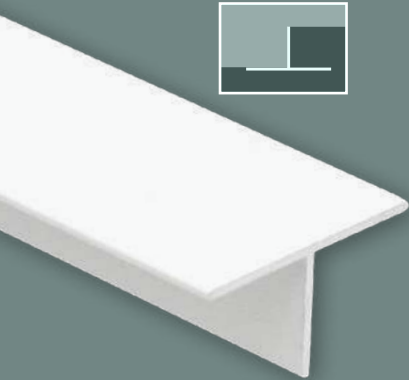

EXTENSION OF SERVICE LIFE
VERLÄNGERUNG LEBENSDAUER

MECHANICAL PROTECTION
MECHANISCHER SCHUTZ

COOLING
KÜHLUNG

HIGH LIGHT UTILISATION
HOHE LICHTVERWERTUNG

HOMOGENEOUS LIGHT
HOMOGENES LICHT

HOMOGENEOUS LIGHT with modular LED light solutions

- Homes
Wohnräume
- Offices, conference and presentation rooms
Büro-, Konferenz- und Präsentationsräume
- Waiting rooms
Ordinationen
- Business premises and sales floors
Geschäfts- und Verkaufsflächen
- Showrooms
- Hotel and gastronomy
Hotellerie und Gastronomie
- Foyers, corridors and connecting rooms
Foyers, Flure und Verbindungsräume
- Waiting and common rooms
Warte- und Aufenthaltsräume
- Commercial premises (e.g. hair salons)
Gewerbliche Dienstleistungsräumlichkeiten (z. B. Friseursalons etc.)

Mounting/installation on/in wood Strips and plates, plasterboard, tiles, stone, granite, marble and metal surfaces
Montage/Einbau auf/in Holzleisten und -platten, Gipsplatten, Fliesen, Stein-, Granit-, Marmor- und Metalloberflächen



TBP14

DRYWALL | TROCKENBAU

LED Strips max. 12 mm

□ RAL 9010 White/Weiß
POWDER-COATED | PULVERBESCHICHTET

■ RAL 9005 Black/Schwarz
POWDER-COATED | PULVERBESCHICHTET



max. 12 mm

max.
12 mm

OEM



Sustainable light integration into the architecture

These innovative LED aluminium profiles are the perfect solution for comprehensive lighting concepts in modern drywall construction. Light source and architectural design element in one!

This T-shaped drywall profile is suitable for LED flex Strips with a maximum width of 12 mm. With its particularly flat design, it can be used to finish off drywall panels and can be mounted on panels of different heights and made of different materials.

It is suitable for lighting designs that need to create indirect lighting and can be mounted horizontally as well as vertically.

TBP14 profiles are powder-coated and available in white and black. In combination with aquaflex Strips, they are also suitable for use in damp rooms and outdoors.

Nachhaltige Licht-Integration in die Architektur

Diese innovativen LED Alu-Profile sind die perfekte Lösung für ganzheitliche Beleuchtungskonzepte im modernen Trockenbau. Lichtquelle und architektonisches Designelement in einem!

Dieses Trockenbauprofil in T-Form ist geeignet für LED Flexbänder mit einer maximalen Breite von 12 mm. Mit seinem besonders flachen Design kann es zum Abschluss von Trockenbauplatten eingesetzt werden und lässt sich auf Platten unterschiedlicher Höhe und aus verschiedenen Materialien anbringen.

Es bietet sich für Lichtdesigns an, die eine indirekte Beleuchtung schaffen sollen und lässt sich horizontal sowie vertikal montieren.

TBP14 Profile sind pulverbeschichtet und in Weiß und Schwarz verfügbar. Sie sind in Kombination mit Aquaflexbändern außerdem für den Einsatz in Feuchträumen und im Freien geeignet.

GALAXY profiles
Perfect Light Lines



TBP14

max.
12 mm

GALAXY profiles
Perfect Light Lines

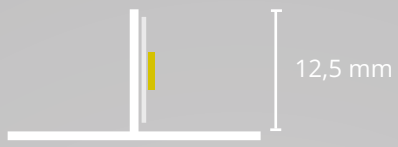

OEM



PROFILE

TBP14  200 cm
8102088  200 cm
8102089

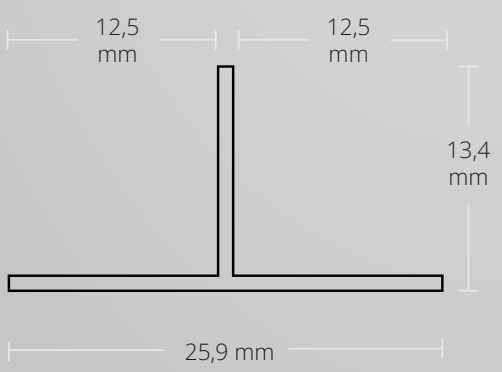
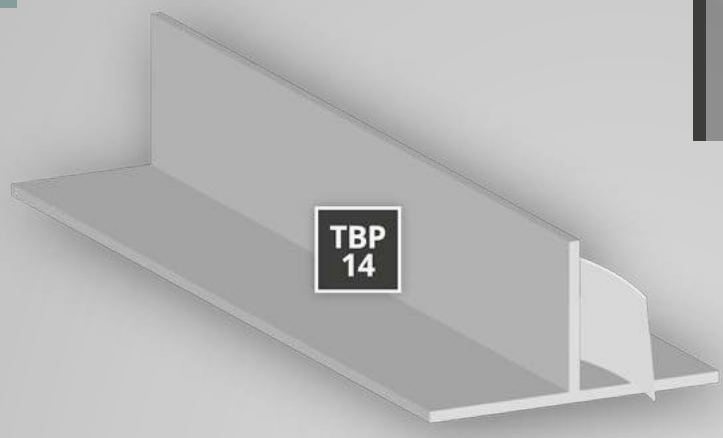



TBP14 DRYWALL | TROCKENBAU

LED Strips max. 12 mm
13,4 mm x 25,9 mm | 94 g/m

□ 200 cm
8102088

■ 200 cm
8102089

max.
12 mm

OEM

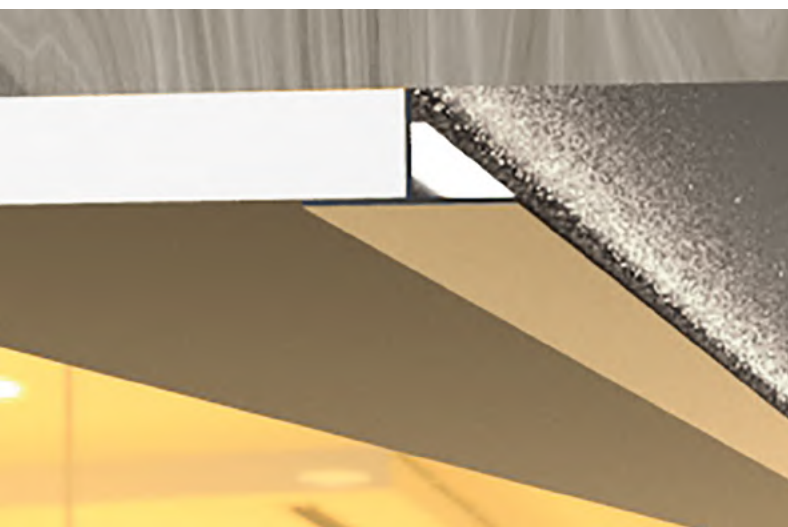

TBP16

DRYWALL | TROCKENBAU

200 cm

max. 12 mm

OEM

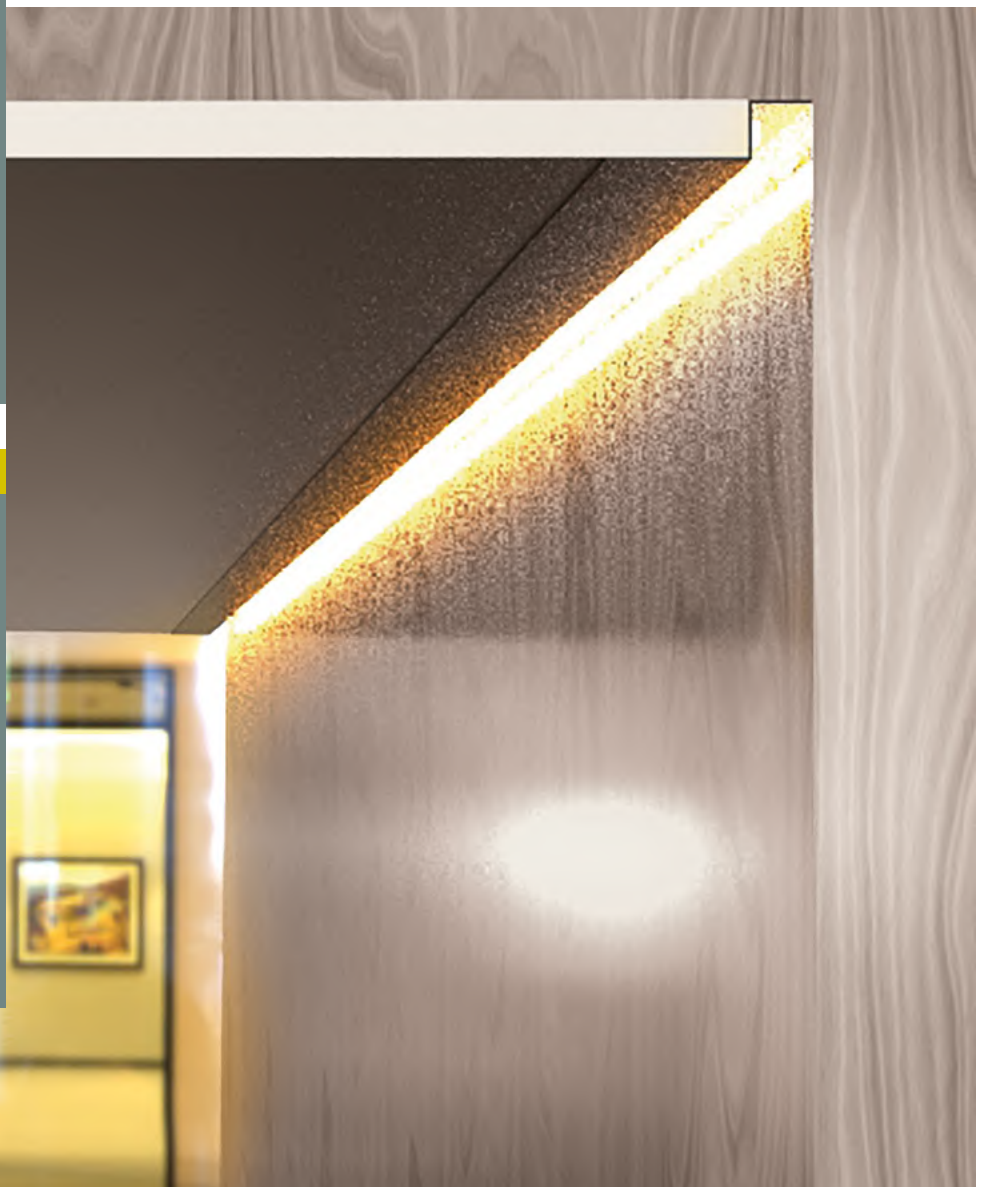
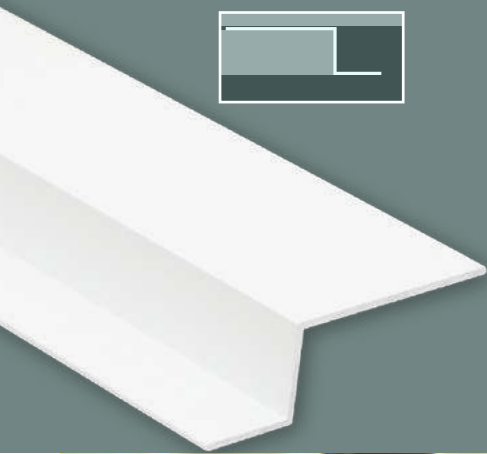

EXTENSION OF SERVICE LIFE
VERLÄNGERUNG LEBENSDAUER

MECHANICAL PROTECTION
MECHANISCHER SCHUTZ

COOLING
KÜHLUNG

HIGH LIGHT UTILISATION
HOHE LICHTVERWERTUNG

HOMOGENEOUS LIGHT
HOMOGENES LICHT

HOMOGENEOUS LIGHT with modular LED light solutions

- Homes
Wohnräume
- Offices, conference and presentation rooms
Büro-, Konferenz- und Präsentationsräume
- Waiting rooms
Ordinationen
- Business premises and sales floors
Geschäfts- und Verkaufsflächen
- Showrooms
- Hotel and gastronomy
Hotellerie und Gastronomie
- Foyers, corridors and connecting rooms
Foyers, Flure und Verbindungsräume
- Waiting and common rooms
Warte- und Aufenthaltsräume
- Commercial premises (e.g. hair salons)
Gewerbliche Dienstleistungsräumlichkeiten (z. B. Friseursalons etc.)

Mounting/installation on/in wood Strips and plates, plasterboard, tiles, stone, granite, marble and metal surfaces
Montage/Einbau auf/in Holzleisten und -platten, Gipsplatten, Fliesen, Stein-, Granit-, Marmor- und Metalloberflächen

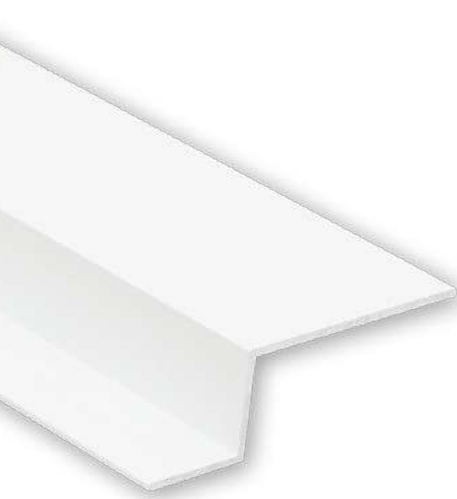

TBP16

DRYWALL | TROCKENBAU

LED Strips max. 12 mm

□ RAL 9010 White/Weiß
POWDER-COATED | PULVERBESCHICHTET

■ RAL 9005 Black/Schwarz
POWDER-COATED | PULVERBESCHICHTET



max. 12 mm

max.
12 mm

OEM

Sustainable light integration into the architecture

These innovative LED aluminium profiles are the perfect solution for comprehensive lighting concepts in modern drywall construction. Light source and architectural design element in one!

An S-shaped drywall profile suitable for LED flex Strips with a maximum width of 12 mm.

Perfect for finishing drywall panels and for shadow gaps. They can also be used to create wallwasher effects, which means walls can be flooded with direct light.

TBP16 profiles are available in white and black. They are also suitable for use in damp rooms and outdoors in combination with flex Strips with the appropriate protection class.

Nachhaltige Licht-Integration in die Architektur

Diese innovativen LED Alu-Profile sind die perfekte Lösung für ganzheitliche Beleuchtungskonzepte im modernen Trockenbau. Lichtquelle und architektonisches Designelement in einem!

Ein Trockenbauprofil in S-Form, das für LED Flexbänder mit einer maximalen Breite von 12 mm geeignet ist. Perfekt für den Abschluss von Trockenbauplatten und für Schattenfugen.

Mit ihnen lässt sich auch Wallwasher-Effekt erzeugen, das heißt Wände können mit direktem Licht geflutet werden.

TBP16 Profile sind in den Farben Weiß und Schwarz verfügbar. Sie sind in Kombination mit Flexbändern mit entsprechender Schutzart außerdem für den Einsatz in Feuchträumen und im Freien geeignet.

GALAXY profiles
Perfect Light Lines

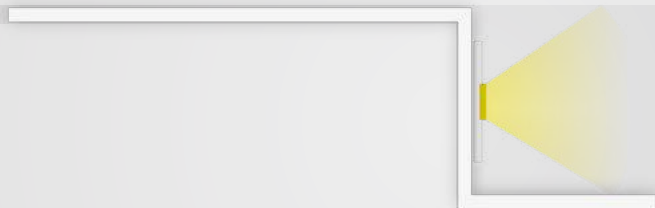

TBP16

max.
12 mm

GALAXY profiles
Perfect Light Lines

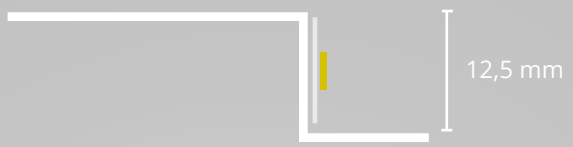

OEM



PROFILE

TBP16  200 cm 8102090  200 cm 8102091

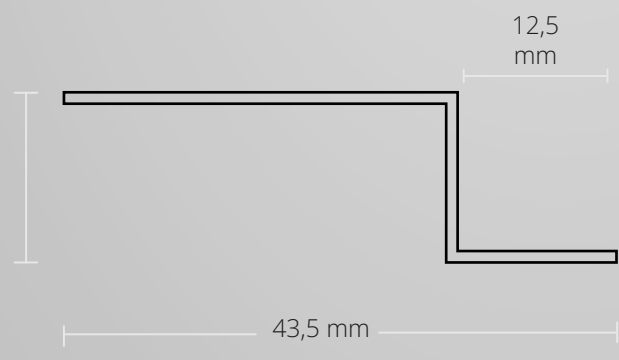
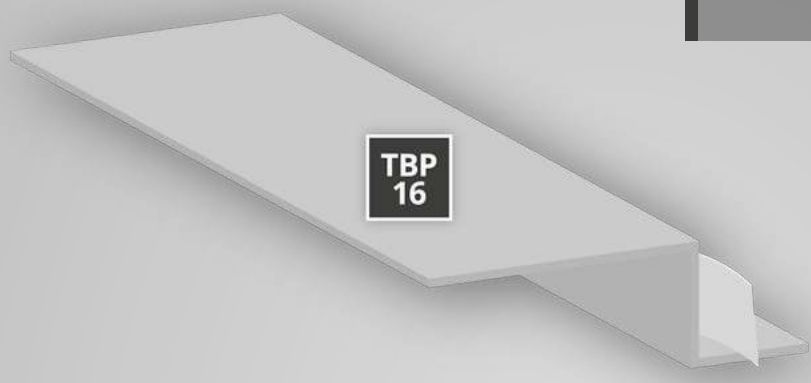

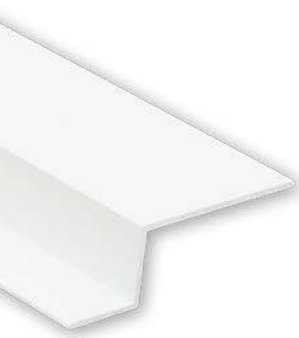

TBP16 DRYWALL | TROCKENBAU

LED Strips max. 12 mm
43,5 mm x 13,4 mm | 139 g/m

200 cm
8102090

200 cm
8102091

max.
12 mm

OEM



RP

DRYWALL | TROCKENBAU

100 cm | 200 cm

max. 10 mm

OEM

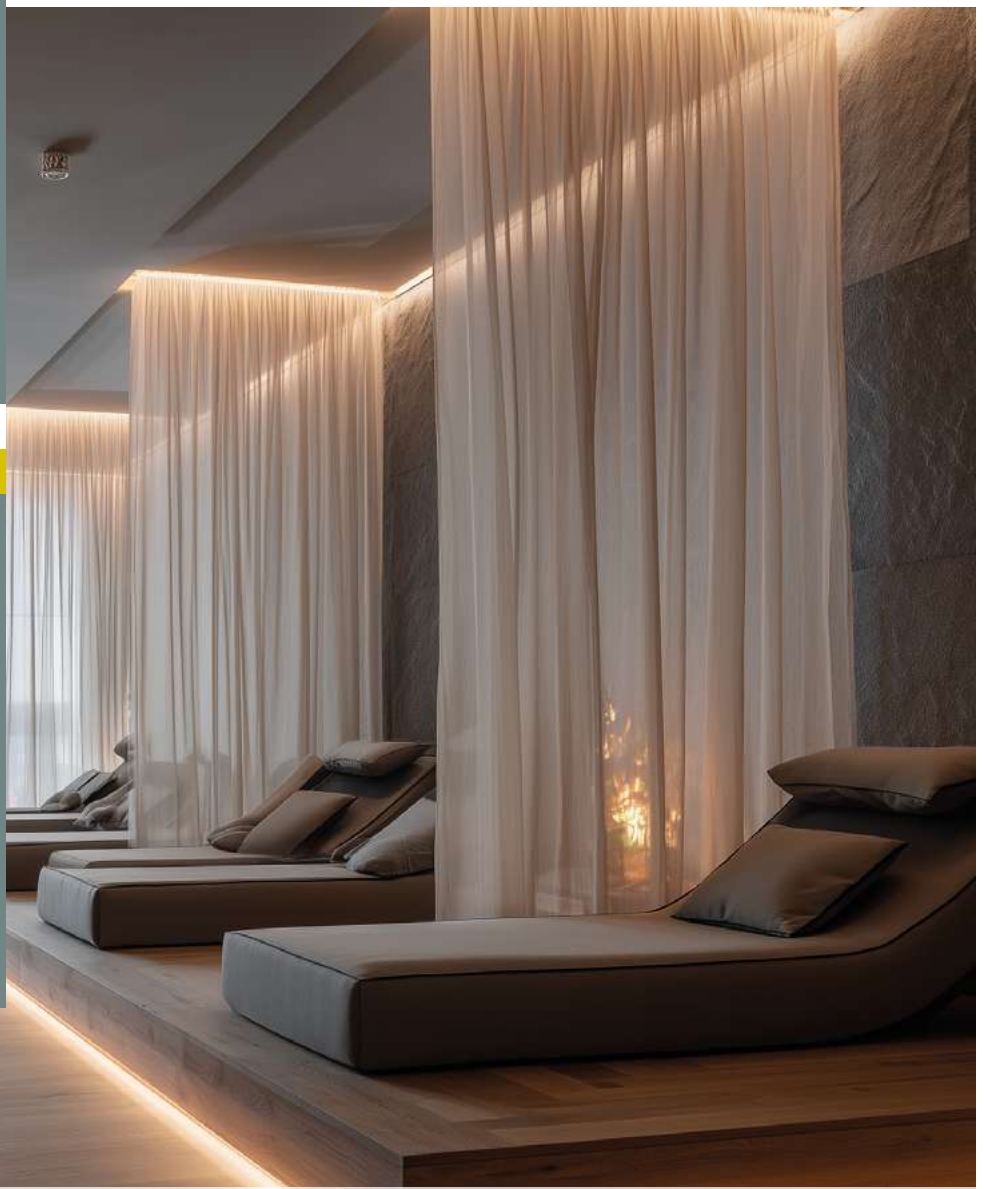
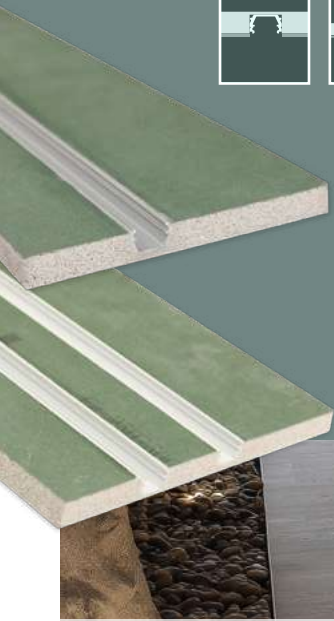

EXTENSION OF SERVICE LIFE
VERLÄNGERUNG LEBENSDAUER

MECHANICAL PROTECTION
MECHANISCHER SCHUTZ

COOLING
KÜHLUNG

HIGH LIGHT UTILISATION
HOHE LICHTVERWERTUNG

HOMOGENEOUS LIGHT
HOMOGENES LICHT

HOMOGENEOUS LIGHT with modular LED light solutions

- Wall, ceiling or floor mounting
Wand-, Decken- oder Bodenmontage
- Living spaces | Wohnräume
- Offices | Büroräume
- Hotel and gastronomy business
Hotellerie und Gastronomie
- Retail (shop and showcase windows)
Einzelhandel (Shop- und Schaufenster)
- Business areas and showrooms
Geschäftsflächen und Showrooms
- Barber / Beauty / body art studios
Friseur-/Beauty-/Body-Art-Studios
- Halls, foyers and corridors
Hallen, Foyers und Flure
- Wellness and indoor leisure facilities
Wellness- und Indoor-Freizeitanlagen
- Hospitals | Krankenhäuser
- Exhibition stands | Messestände



RP

DRYWALL | TROCKENBAU

Flat | Flach | LED Strips max. 10 mm

 Silver | Silber



max. 10 mm

RP drywall profiles are the ideal solution for modern lighting concepts. They are supplied as finished water-repellent drywall panels and can be integrated directly into the structure. The RP1 offers space for one LED flex strip up to 10 mm, while the RP2 offers space for two flex strips.

Installation is particularly easy: the profiles are screwed and filled, creating a clean and professional result. The design ensures a seamless connection to the wall or ceiling.

Whether in living rooms, corridors, offices or commercial properties, RP profiles enable the discreet integration of LED lighting and create harmonious lighting scenarios from accent to functional lighting.

The covers made of shatterproof, flame-retardant polycarbonate (UL94 V-2) are available in opal/satin (65%), clear (85%) and black/matt (25%). They close flush and ensure homogeneous lighting conditions. PC inlays can also be used to integrate curtains or glue in LED flex strips.

* Classification flammability UL94 V-2: Extinguishing of a vertically clamped sample within 30 seconds

Die RP-Trockenbauprofile sind eine ideale Lösung für moderne Lichtkonzepte. Sie werden als fertige wasserabweisende Trockenbauplatten geliefert und lassen sich direkt in die Konstruktion integrieren. Das RP1 bietet Platz für ein LED-Flexband bis 10 mm, das RP2 für zwei Flexbänder.

Die Montage ist besonders einfach: Die Profile werden verschraubt und verspachtelt, wodurch ein sauberes und professionelles Ergebnis entsteht. Die Bauform sorgt für eine nahtlose Verbindung zu Wand oder Decke.

Ob in Wohnräumen, Fluren, Büros oder gewerblichen Objekten – die RP-Profile ermöglichen eine dezente Integration von LED-Beleuchtung und schaffen harmonische Lichtszenarien von Akzent- bis Funktionslicht.

Die Abdeckungen aus bruchsicherem, schwer entflammbarem Polycarbonat (UL94 V-2) sind in Opal/satiniert (65%), Klar (85%) und Schwarz/matt (25%) erhältlich. Sie schließen bündig ab und sorgen für homogene Lichtverhältnisse. Mit PC-Inlays lassen sich auch Gardinen integrieren oder LED-Flexbänder einkleben.

*Klassifizierung Brennbarkeit UL94 V-2: Verlöschen einer vertikal eingespannten Probe innerhalb von 30 Sekunden

GALAXY profiles
Perfect Light Lines

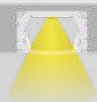

RP1 + C1



RP1 + C1 + CV1 + Z66

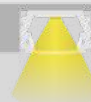

RP1 + C1 + CV1 + Z66

max.
10 mm

OEM

GALAXY profiles
Perfect Light Lines

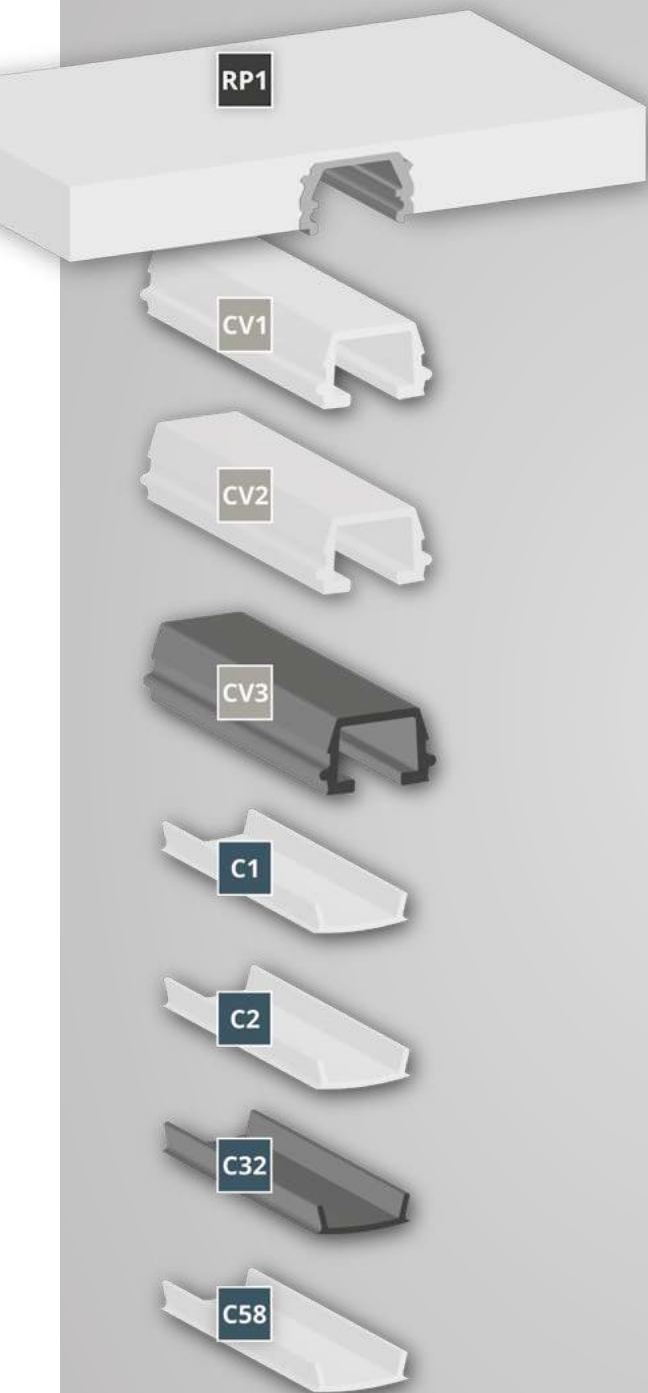
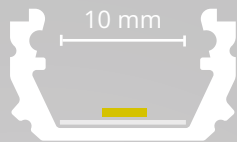

PC-INLAYS

CV1 65 %	100cm 8123581	200 cm 8123550
CV2 85 %	100 cm 8123582	200 cm 8123551
CV3 25 %	100 cm 8123593	200 cm 8123592

COVERS | ABDECKUNGEN

C1 65 %	200cm 8600004	250 cm 8600026	300 cm 8600080	600 cm 8600037
C2 85 %	200 cm 8600003	250 cm 8600135	300 cm 8600136	
C58 75 %	200 cm 8600154			
C32 25 %	200 cm 8600070	300 cm 8600103	600 cm 8600071	

PROFILE

RP	RP1 - SINGLE	
	100 cm 8123579	200 cm 8123548
	RP2 - DOUBLE	
	100 cm 8123580	200 cm 8123549



Z66
100 pcs./stk.
8192335

Z72	opal opal 8192336	clear klar 8123610	black schwarz 8192337
Z73	8123552		

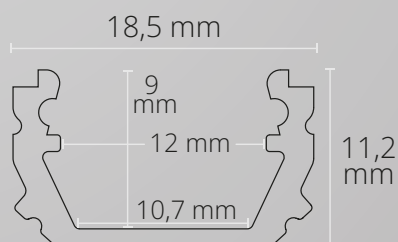



RP DRYWALL | TROCKENBAU

incl. protective cover | inkl. Schutzcover | LED Strips max. 10 mm

RP1 | Single | Einbahnig
17,7 mm x 18,3 mm | 332 g/m

100 cm **8123579** 200 cm **8123548**

RP2 | Double | Zweibahnig
17,7 mm x 18,3 mm | 332 g/m

100 cm **8123580** 200 cm **8123549**

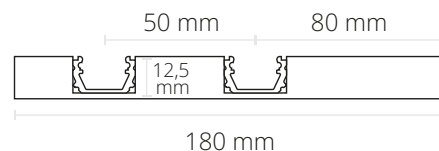
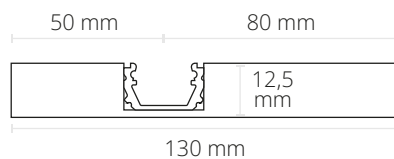

max.
10 mm
OEM



Z66
Roller glider for PC-Inlay | 100 pcs.
Rollingleiter für PC-Inlay | 100 stk.
8192335

Z72 NEW

Curtain insertion aid
Vorhangschleuse

opal | opal **8192336**
clear | klar **8123610**
black | schwarz **8192337**



Z73 NEW

Lock for curtain track
Feststeller für Vorhanglauf

8123552



COVERS | ABDECKUNGEN

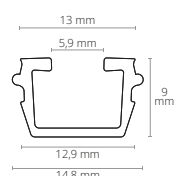
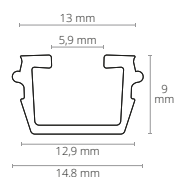
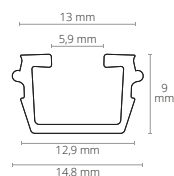

C1 opal/satinised | opal/satiniert | 65 %
PC | 13,81 mm x 4,37 mm
200cm **8600004** 250cm **8600026** 600cm **8600037**

C2 transparent | klar | 85 %
PC | 13,81 mm x 4,37 mm
200cm **8600003** 250cm **8600135** 300cm **8600136**

C32 black/matt | schwarz/matt | 25 %
PC | 13,81 mm x 4,37 mm
200cm **8600070** 600cm **8600071**

C58 white/matt | weiß/matt | 75 %
PC | 13,8 mm x 4,4 mm
200cm **8600154**

CV1 opal/satinised | opal/satiniert | 65 %
PC | 14,8 mm x 9 mm
100cm **8123581** 200cm **8123550**

CV2 clear | klar | 85 %
PC | 14,8 mm x 9 mm
100cm **8123582** 200cm **8123551**

CV3 black/matt | schwarz/matt | 25 %
PC | 14,8 mm x 9 mm
100cm **8123593** 200cm **8123592**

SR

RECESSED | EINBAU
SILICONE COVER | SILIKONCOVER

500 cm | 2000 cm

max. 10 mm / 15 mm



EXTENSION OF SERVICE LIFE
VERLÄNGERUNG LEBENSDAUER

MECHANICAL PROTECTION
MECHANISCHER SCHUTZ

HIGH LIGHT UTILISATION
HOHE LICHTVERWERTUNG

HOMOGENEOUS LIGHT
HOMOGENES LICHT

HOMOGENEOUS LIGHT with modular LED light solutions

- Wall, ceiling or floor mounting
Wand-, Decken- oder Bodenmontage
- Residential and office furniture
Wohn- und Büromöbel
- Furniture for business equipment
Möbel für Geschäftsausstattung
- Home accessories
Wohnaccessoires
- Mirrors | Spiegel
- Cabinet doors | Schranktüren
- Display cases | Vitrinen
- Shelves | Regale
- Stairs and railings
Treppenstufen und -Geländer
- Balustrades | Balustraden
- Façades, balconies and terraces
Fassaden, Balkone und Terrassen
- Living spaces | Wohnräume
- Offices | Büroräume
- Hotel and gastronomy business
Hotellerie und Gastronomie
- Retail (shop and showcase windows)
Einzelhandel (Shop- und Schaufenster)
- Business areas and showrooms
Geschäftsflächen und Showrooms
- Barber / Beauty / body art studios
Friseur-/Beauty-/Body-Art-Studios
- Halls, foyers and corridors
Hallen, Foyers und Flure
- Wellness and indoor leisure facilities
Wellness- und Indoor-Freizeitanlagen
- Wet rooms | Nasszellen

Mounting/installation on/in wood Strips and plates, plasterboard, tiles, stone, granite, marble and metal surfaces
Montage/Einbau auf/in Holzleisten und -platten, Gipsplatten, Fliesen, Stein-, Granit-, Marmor- und Metalloberflächen



SR1 | SR2

RECESSED | EINBAU

Silicon cover | Silikoncover | LED Strips max. 10 mm / 15 mm

Opal/Opal
SILICON | SILIKON

Black/Schwarz
SILICON | SILIKON



max. 10 mm / 15 mm

The SR1 and SR2 silicone covers are perfect for moulding into wood. Flexible lighting concepts can be realised with both the more delicate SR1 variant and the SR2 cover. The combination of wood and light creates a unique visual effect. A special lighting effect is also achieved in conjunction with acoustic panels. The cover is available in the colours black and opal. The SR1 cover is suitable for a maximum LED stripe width of 10 mm and the SR2 cover for a maximum LED stripe width of 15 mm.

Use flexbands with an output of 5 to 10 W to avoid the need for a cooling profile. Otherwise, we recommend the silicone cover in combination with our PN33 cooling profile, the PL4 profile or for the PN8 profile for optimum results.

With a horizontal bending radius of at least 100 mm and a vertical bending radius of at least 50 mm, the cover can be used in a variety of ways, for example in the home, for furniture lighting, in offices, but also in the hotel and catering industry. The cover can also be used outdoors with the appropriate flex tape.

Die Silikoncover SR1 und SR2 sind perfekt für das Einfräßen in Holz geeignet. Sowohl mit der filigraneren Variante SR1 als auch mit dem SR2 Cover, lassen sich flexible Lichtkonzepte umsetzen. Die Kombination aus Holz und Licht erzeugt eine einzigartige optische Wirkung. Auch zusammen mit Akustikpanelen wird eine besondere Lichtwirkung erzielt. Das Cover ist in den Farben schwarz und opal erhältlich. Das Cover SR1 ist für eine maximale Flexbandbreite von 10 mm und das Cover SR2 für eine maximale Flexbandbreite von 15 mm geeignet.

Verwenden Sie Flexbänder mit einer Leistung von 5 bis 10 W, um auf den Einsatz eines Kühlprofils verzichten zu können. Andernfalls empfehlen wir das Silikoncover in Kombination mit unserem Kühlprofil PN33, dem Profil PL4 oder das Profil PN8 für optimale Ergebnisse.

Mit einem horizontalen Biegeradius von mind. 100 mm und einem vertikalen Biegeradius von mind. 50 mm ist das Cover vielfältig einsetzbar, beispielsweise im Wohnbereich, für Möbelbeleuchtungen, in Büroräumen, aber auch in Hotellerie und Gastronomie. Auch im Außenbereich ist das Cover mit dem richtigen Flexband einsetzbar.

GALAXY profiles
Perfect Light Lines

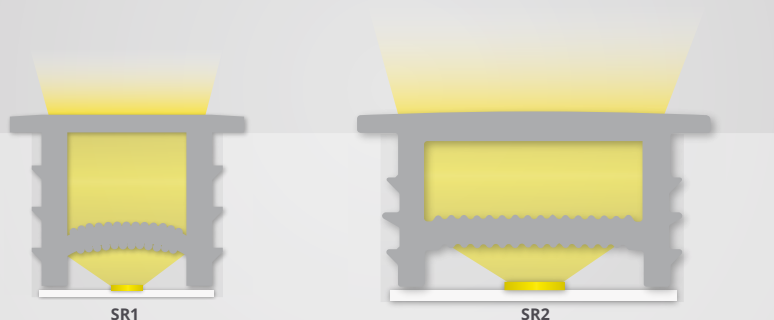

- max. 10 mm
- max. 15 mm
-
-

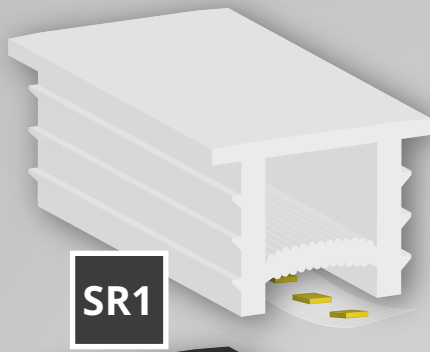

SR1

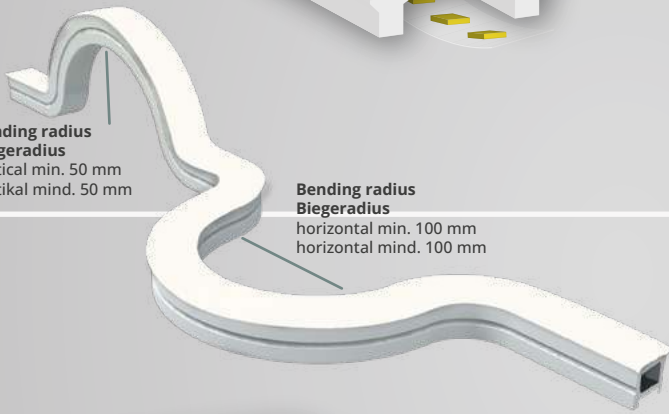
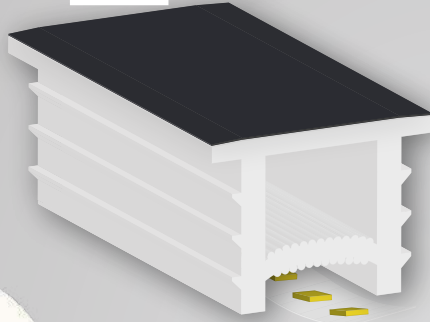

**Bending radius
Biegeradius**
vertical min. 50 mm
vertikal mind. 50 mm

**Bending radius
Biegeradius**
horizontal min. 100 mm
horizontal mind. 100 mm

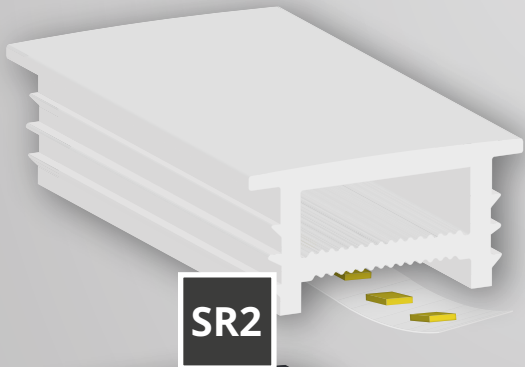

SR2

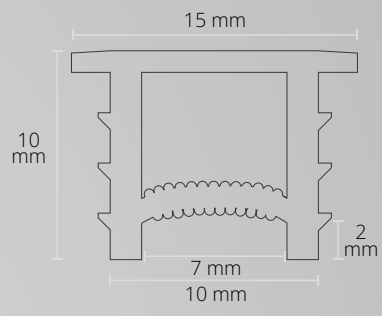
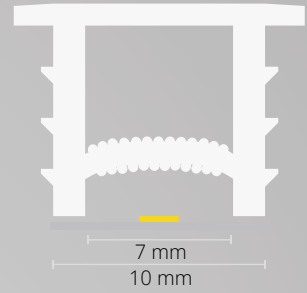
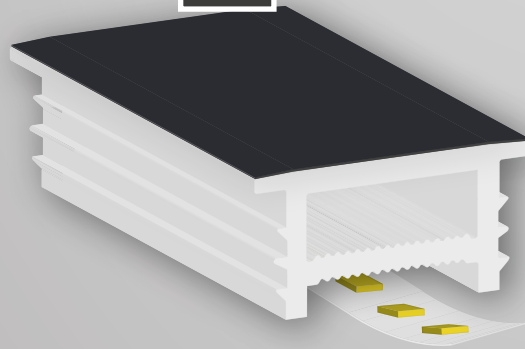

COVER | ABDECKUNG

SR1	500 cm 8123426	500 cm 8123424
	2000 cm 8123427	2000 cm 8123425

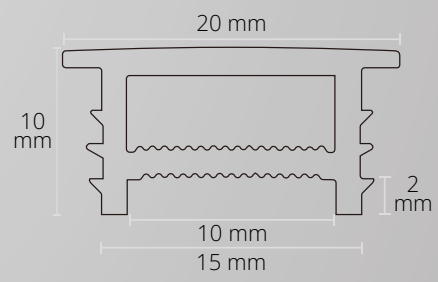
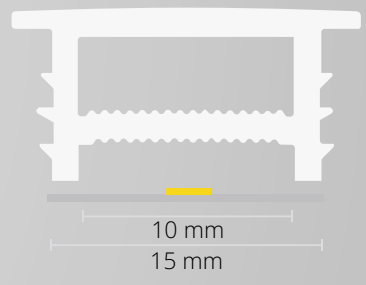

COVER | ABDECKUNG

SR2	500 cm 8123430	500 cm 8123428
	2000 cm 8123431	2000 cm 8123429



SR1 RECESSED | EINBAU

Silicon cover | Silikoncover | LED Strips max. 10 mm
10 mm x 10 mm

500 cm
8123426

2000 cm
8123427

500 cm
8123424

2000 cm
8123425

max.
10 mm

max.
15 mm



SR2 RECESSED | EINBAU

Silicon cover | Silikoncover | LED Strips max. 15 mm
15 mm x 10 mm

500 cm
8123430

2000 cm
8123431

500 cm
8123428

2000 cm
8123429



INSTALLATION INSTRUCTION
INSTALLATIONS MONTAGE



LL2

LUMINAIRE | LEUCHE

200 cm

max. 40mm | max. 5mm

OEM

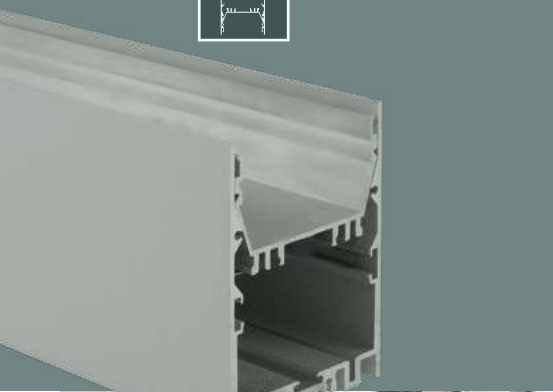

EXTENSION OF SERVICE LIFE
VERLÄNGERUNG LEBENSDAUER

MECHANICAL PROTECTION
MECHANISCHER SCHUTZ

COOLING
KÜHLUNG

HIGH LIGHT UTILISATION
HOHE LICHTVERWERTUNG

HOMOGENEOUS LIGHT
HOMOGENES LICHT

HOMOGENEOUS LIGHT with modular LED light solutions

- Wall, ceiling or floor mounting
Wand-, Decken- oder Bodenmontage
- Residential and office furniture
Wohn- und Büromöbel
- Furniture for business equipment
Möbel für Geschäftsausstattung
- Home accessories
Wohnaccessoires
- Mirrors | Spiegel
- Cabinet doors | Schranktüren
- Display cases | Vitrinen
- Shelves | Regale
- Stairs and railings
Treppenstufen und -Geländer
- Balustrades | Balustraden
- Façades, balconies and terraces
Fassaden, Balkone und Terrassen
- Living spaces | Wohnräume
- Offices | Büroräume
- Hotel and gastronomy business
Hotellerie und Gastronomie
- Retail (shop and showcase windows)
Einzelhandel (Shop- und Schaufenster)
- Business areas and showrooms
Geschäftsflächen und Showrooms
- Barber / Beauty / body art studios
Friseur-/Beauty-/Body-Art-Studios
- Halls, foyers and corridors
Hallen, Foyers und Flure
- Wellness and indoor leisure facilities
Wellness- und Indoor-Freizeitanlagen
- Wet rooms | Nasszellen

Mounting/installation on/in wood Strips and plates, plasterboard, tiles, stone, granite, marble and metal surfaces
Montage/Einbau auf/in Holzleisten und -platten, Gipsplatten, Fliesen, Stein-, Granit-, Marmor- und Metalloberflächen



LL2

LUMINAIRE | LEUCHE

UP & DOWN | LED Strips max. 40 mm / max. 5 mm

Silver/Silber
POWDER-COATED
PULVERBESCHICHTET

RAL 9003 White/Weiß
POWDER-COATED
PULVERBESCHICHTET

RAL 9005 Black/Schwarz
POWDER-COATED
PULVERBESCHICHTET



max. 40 mm
max. 5 mm

max.
40 mm

max.
5 mm



OEM



The LL2 LED LIGHT profile UP & DOWN has a standard length of 200 cm and is made of high-quality aluminium (anodised). It consists of two components LL2 + LL2.1, which are connected with a mounting bracket. To secure the profile, we recommend attaching the fall protection Z28. This profile system is designed as an independent linear light and is mounted with a cable system. The ideal lighting for offices and shops (retail).

LED stripes with a max. width of 5 mm can be attached on the top side of the ALU profile, and flexbands with a max. total width of 40 mm can be attached on the bottom. The large surface of the profile dissipates the resulting heat perfectly. This allows the use of high-performance LED light Strips.

The wiring and the required LED technology (transformer, sequencer, etc.) are stored professionally and safely in the spacing. The white LED profile covers are made of shatterproof and flame-retardant polycarbonate*, connect flush on the inside and create homogeneous LED lighting conditions with high utilisation of the light output. Matching aluminum end caps close the side openings.

* Classification flammability UL94 V-2: Extinguishing of a vertically clamped sample within 30 seconds

Das LL2 LED Leuchtenprofil UP & DOWN hat eine Standardlänge von 200 cm und wird aus qualitativ hochwertigem Aluminium gefertigt. Es setzt sich aus zwei Komponenten LL2 + LL2.1 zusammen, die mit einer Montageklammer verbunden werden. Um das Profil zu sichern, empfehlen wir die Absturzsicherung Z28 zu befestigen. Dieses Profilsystem ist als eigenständige lineare Leuchte konzipiert und wird mit einem Seilsystem montiert. Die ideale Beleuchtung für Büros und Shops (Retail).

Auf der Oberseite des ALU-Profiles werden LED Flexbänder mit einer max. Breite von 5 mm und auf der Unterseite mit einer max. Gesamtbreite von 40 mm eingeklebt. Die große Oberfläche des Profils leitet die entstehende Wärme ausgezeichnet ab. Dies erlaubt den Einsatz von besonders leistungsstarken LED Lichtbändern.

Im Zwischenraum werden die Verkabelung sowie die benötigte LED Technik (Trafo, Sequenzer etc.) professionell und sicher verstaut. Die weißen LED Profilabdeckungen bestehen aus bruchsicherem und schwer brennbarem Polycarbonat*, schließen innenseitig bündig ab und schaffen homogene LED Lichtverhältnisse mit hoher Verwertung der Lichtleistung. Passende ALU-Endkappen verschließen die seitlichen Öffnungen.

*Klassifizierung Brennbarkeit UL94 V-2: Verlöschten einer vertikal eingespannten Probe innerhalb von 30 Sekunden

GALAXY profiles
Perfect Light Lines

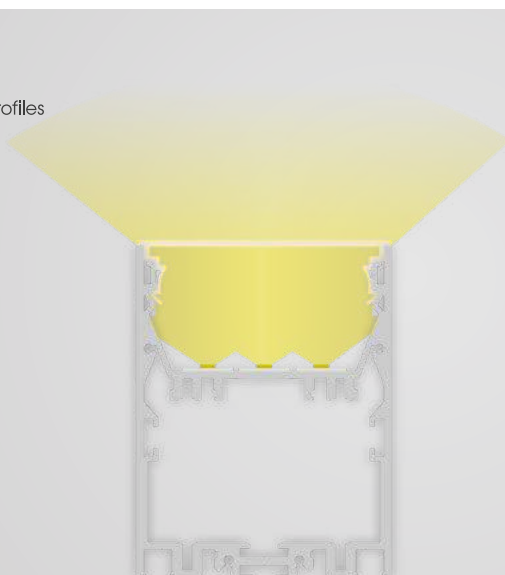

LL2 + LL2.1 + C38

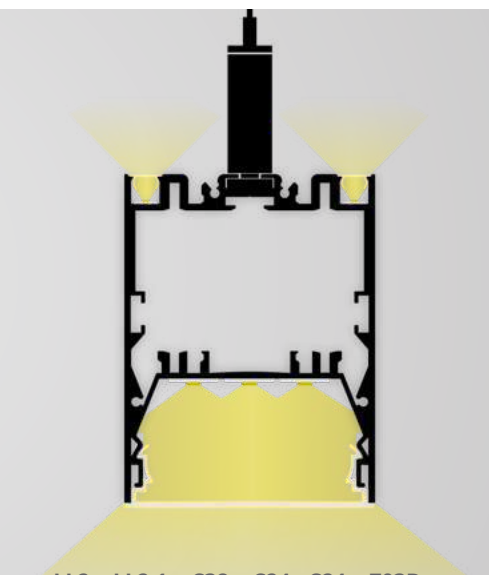

LL2 + LL2.1 + C38 + C24 + C24 + Z03B 279

max. 40 mm

max. 5 mm

OEM

GALAXY profiles
Perfect Light Lines

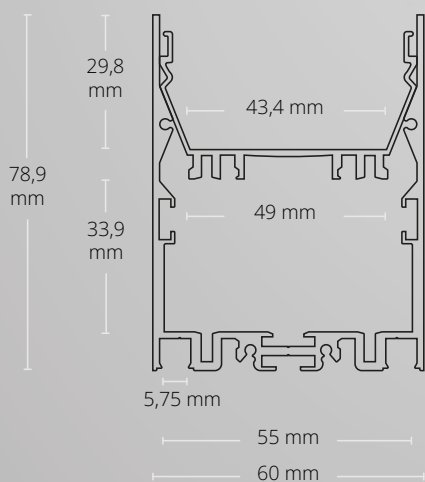
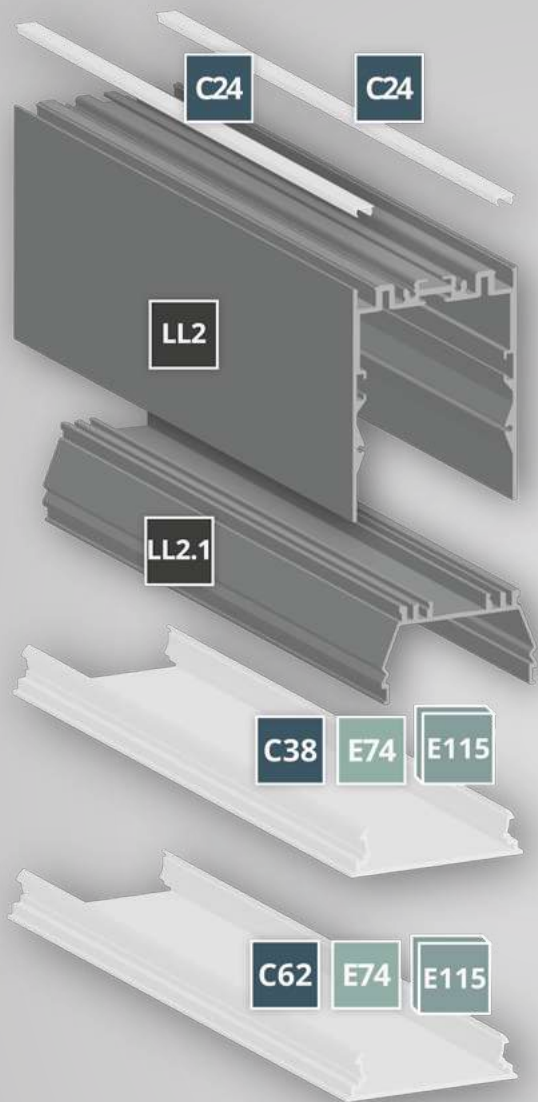
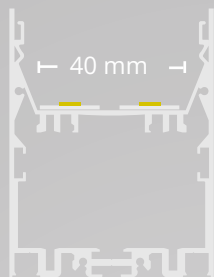

COVERS | ABDECKUNGEN

C62 80 % 200cm 8123343 300cm 8506152

C38 75 % 200cm 8600082

C24 65 % 200cm 8600106 600cm 8600107

END CAPS | ENDKAPPEN

E74 E74 8107210 E74 8107212 E74 8107211

E115 E115 8123356 E115 8123358 E115 8123357

PROFILE

LL2 200 cm 8107110 200 cm 8107112 200cm 8107111
300 cm 8107216 300 cm 8107218 300 cm 8107217

LL2.1 200 cm 8107123
300 cm 8123329

Z30 8107215 Z29 8107214

Z25 8301513 Z26 8301514

Z27 8301515 Z50 8123360

Z56 8123423 Z56W 8123422 Z56B 8123421

Z59 8123434

LINEAR LED PENDANT LAMP | LINEARE LED HÄNGELEUCHE

Z03 8301502 Z03W 8301512 Z03B 8301511

INSTALLATION INSTRUCTION
INSTALLATIONS MONTAGE



LL2 LUMINAIRE | LEUCHE

UP & DOWN | LED Strips max. 40 mm / max. 5 mm
78,9 mm x 60 mm | 1990 g/m

max. 40 mm

max. 5 mm

OEM

LL2

- | | | |
|--------------------------|--------------------------|--------------------------|
| 200 cm
8107110 | 200 cm
8107112 | 200 cm
8107111 |
| 300 cm
8107216 | 300 cm
8107218 | 300 cm
8107217 |

LL2.1

- | |
|--------------------------|
| 200 cm
8107123 |
| 300 cm
8123329 |

Z29
Holding bracket
Halteklammer
Sheet steel | Stahlblech
■ **8107214**

Z30
Mounting Clips
Montageklammer
Sheet steel | Stahlblech
■ **8107215**

Z56
Connector | Verbinder
90° corner welded | 90° Eck geschweißt
140x140mm

Z28
Fall protection
Absturzsicherung
Steel | Stahl
■ **8301516**

Z50
Connecting element
Verbindungselement
■ **8123360**

- **8123423**
- **8123422**
- **8123421**



More P. 406 | Mehr S. 406

Z25
Connector | Verbinder
Steel | Stahl | 4 PCS/STK
180°
■ **8301513**

Z26
Connector | Verbinder
Steel | Stahl | 4 PCS/STK
90°
■ **8301514**

Z27
Connector | Verbinder
Steel | Stahl | 4 PCS/STK
Side/Seite 90°
■ **8301515**

Z59
Cable inlet cover
Kabeleinlassabdeckung
Für Round bores with a diameter of 35 mm
Für Rundbohrungen mit Durchmesser von 35mm
■ **8123434**



COVERS | ABDECKUNGEN

C38 frosted/gefrostet | 75 %
PC | 15,2 mm x 60 mm
200cm
8600082

C62 OpalPlus | 80 %
PC | 15,2 mm x 60 mm
200cm **8123343** 300cm **8506152**

C24 opal | opal | 65 %
PC | 3,9 mm x 7,8 mm
200cm **8600106** 600cm **8600107**



END CAPS | ENDKAPPEN

E74 Aluminium | 2 PCS/STK
■ E74 **8107210** □ E74 **8107212** ■ E74 **8107211**

E115 Plastic | Kunststoff | 2 PCS/STK
■ E115 **8123356** □ E115 **8123358** ■ E115 **8123357**

LINEAR LED PENDANT LAMP | LINEARE LED HÄNGELEUCHE

The following accessories can be attached directly to the profile. Folgendes Zubehör kann direkt ans Profil angebracht werden.

Z03 Hanging Wire System | Seilabhängung
Steel | Stahl | 1,5 m | Set | 75 kg
■ Z03 **8301502** □ Z03W **8301512** ■ Z03B **8301511**

max.
40 mm

max.
5 mm



OEM



LL2 Mounting | Montage

The LL2 LED aluminium profile system consists of the two high-quality components LL2 + LL2.1. These are connected to each other with the Z29 clamp. To additionally secure the profile, we recommend fixing the Z28 fall protection device to the profile system.

This profile system is designed as an independent linear lighting system. The cable suspension Z03 can be attached directly to the luminaire. An additional mounting clamp Z30 makes it possible to fixate the profile or fixate the cables inside.

The cabling and the necessary LED technology (transformer, sequencer etc.) are professionally and safely stowed away in the space in-between. The white LED profile covers C38 and two C24 can be clicked into the profile. Matching aluminium end caps close the side openings.

Das LL2 LED Alu-Profilsystem setzt sich aus den beiden hochwertigen Komponenten LL2 + LL2.1 zusammen. Diese werden mit der Halteklammer Z29 miteinander verbunden. Um das Profil zusätzlich zu sichern, empfehlen wir, die Absturzsicherung Z28 am Profilsystem zu fixieren.

Dieses Profilsystem ist als eigenständige lineare Leuchte konzipiert. Die Seilabhängung Z03 kann direkt an der Leuchte befestigt werden. Eine zusätzliche Montageklammer Z30 ermöglicht es, das Profil zu befestigen oder die Kabel im Inneren zu fixieren.

Im Zwischenraum werden die Verkabelung sowie die benötigte LED Technik (Trafo, Sequenzer etc.) professionell und sicher verstaut. Die weißen LED Profilabdeckungen C38 und zwei Mal C24 können in das Profil eingeklickt werden. Passende ALU-Endkappen verschließen die seitlichen Öffnungen.

BRACKET | KLAMMERN

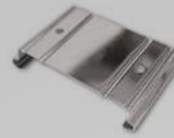

Z29
Holding bracket
Halteklammer
Sheet steel | Stahlblech
□ **8107214**



Z30
Mounting Clips
Montageklammer
Sheet steel | Stahlblech
□ **8107215**

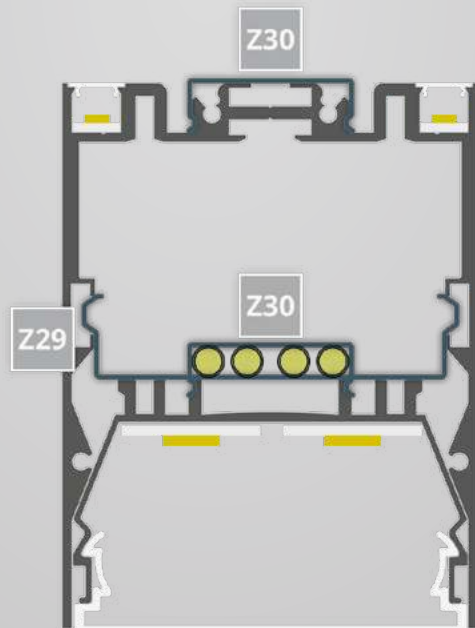
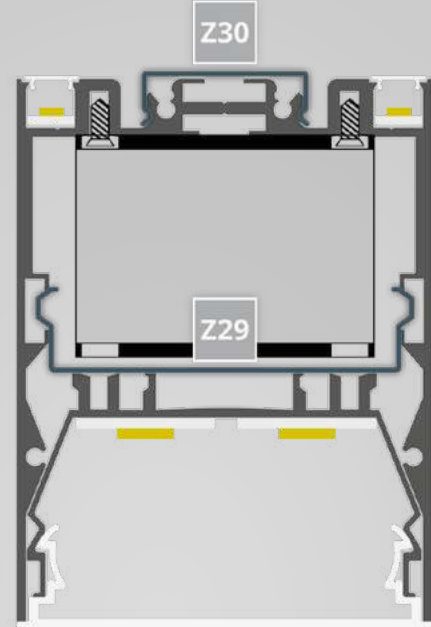

PROTECTION | SICHERUNG



Z28
Fall protection
Absturzsicherung
Steel | Stahl
□ **8301516**



CONNECTOR | VERBINDER

max.
40 mm

max.
5 mm



OEM

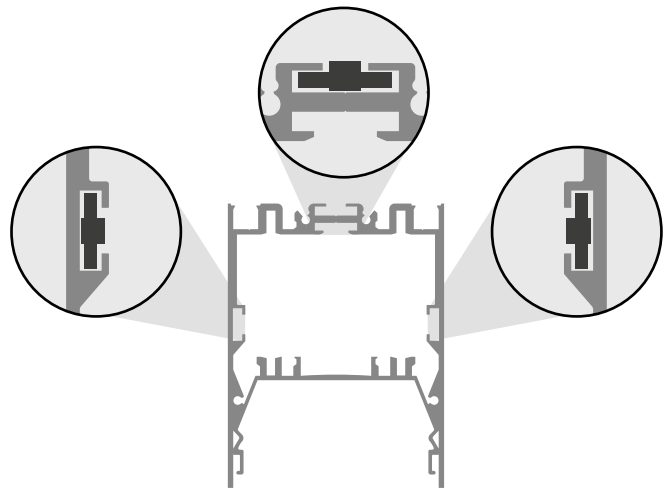

Z25 Connector | Verbinder

Steel | Stahl | 4 PCS/STK

Z25 | 180°
8301513



Z26 Spring-Gripper | Montagefeder

Steel | Stahl

Z26 | 90°
8301514



Z27 Connector | Verbinder

Steel | Stahl | 4 PCS/STK

Z27 | Side/Seite 90°
8301515



Z56 Connector | Verbinder

90° corner welded | 90° Eck geschweißt

140x140mm | Connect like Z25 | Verbinden wie Z25

8123423 8123422 8123421



180° CONNECTION | VERBINDUNG

To create a 180° connection, 3x 180° connectors (item no 8301513) are required.

Um eine 180° Verbindung zu erreichen, werden 3 Stück Verbinder 180° (Art. Nr. 8301513) benötigt.



Z25 Connector | Verbinder

Steel | Stahl | 4 PCS/STK

Z25 | 180°
8301513



90° CONNECTION | VERBINDUNG

For a horizontal 90° connection, 1 connector 90° horizontal (item no 8301514) and 2 connectors 90° vertical (item no 8301515) are required.

Für eine horizontale 90° Verbindung werden 1 Stück Verbinder 90° Horizontal (Art. Nr. 8301514) und 2 Stück Verbinder 90° Vertikal (Art. Nr. 8301515) benötigt.



Z27

Steel | Stahl | 4 PCS/STK

Z27 | Side/Seite 90°
8301515



Z26

Steel | Stahl

Z26 | 90°
8301514



90° CONNECTION | VERBINDUNG

For a horizontal 90° connection, 2 connectors 90° horizontal (item no 8301514) and 1 connector 90° vertical (item no 8301515) are required.

Für eine vertikale 90° Verbindung werden 2 Stück Verbinder 90° Horizontal (Art. Nr. 8301514) und 1 Stück Verbinder 90° Vertikal (Art. Nr. 8301515) benötigt.



Z27

Steel | Stahl | 4 PCS/STK

Z27 | Side/Seite 90°
8301515



Z26

Steel | Stahl

Z26 | 90°
8301514



SP1

STAIR | TREPPE

200 cm

max. 13 mm

OEM



EXTENSION OF SERVICE LIFE
VERLÄNGERUNG LEBENSDAUER

MECHANICAL PROTECTION
MECHANISCHER SCHUTZ

COOLING
KÜHLUNG

HIGH LIGHT UTILISATION
HOHE LICHTVERWERTUNG

HOMOGENEOUS LIGHT
HOMOGENES LICHT

HOMOGENEOUS LIGHT with modular LED light solutions

- Steps and stairs inside and out
Stufen und Treppen im Innen- und Outdoor-Bereich

Mounting/installation on/in wood Strips and plates, plasterboard, tiles, stone, granite, marble and metal surfaces
Montage/Einbau auf/in Holzleisten und -platten, Gipsplatten, Fliesen, Stein-, Granit-, Marmor- und Metalloberflächen



SP1

STAIR | TREPPE

LED Strips max. 13 mm

Silver/Silber
ANODIZED | ELOXIERT



max. 13 mm

max.
13 mm



OEM



Sure footing with effective lighting!

The SP1 LED STAIR Profile is 200cm long as standard and is made from high-quality aluminium (anodised). This profile is non-slip and especially designed for mounting on steps and stairs.

An LED flex strip up to a maximum of 13 mm in width can be mounted to this aluminium profile. The profile's large surface area means heat dissipates excellently. This allows the use of high-performance LED light strips. The lit side of the profile tilts inwards. This prevents glare when climbing the stairs.

The LED profile covers opal/satinised (translucency 65 %), clear (translucency 85 %) or black matt (translucency 25 %) are made from shatterproof, flame-retardant polycarbonate (classification flammability UL94 V-2), provides a flush finish and ensures a uniform light with high transfer of the light output. Matching PVC end caps close the side openings, protecting the inside of the STAIR profiles.

Sicherer Tritt mit effektvoller Beleuchtung!

Das SP1 LED TREPPEN-Profil hat eine Standardlänge von 200 cm und wird aus qualitativ hochwertigem Aluminium (eloxiert) gefertigt. Das Profil ist trittsicher und explizit für die Montage an Stufen und Treppen konzipiert.

Dieses ALU-Profil kann mit einem LED Strip mit einer max. Breite von 13 mm bestückt werden. Die große Oberfläche des Profils leitet die entstehende Wärme ausgezeichnet ab. Dies erlaubt den Einsatz von leistungsstarken LED Lichtbändern. Die beleuchtete Seite des Profils ist nach innen geneigt. Damit wird ein Blenden beim Hinaufsteigen der Treppe vermieden.

Die LED Profilabdeckungen Opal/satiniert (Lichtdurchlässigkeit 65 %), Klar (Lichtdurchlässigkeit 85 %) oder Schwarz Matt (Lichtdurchlässigkeit 25 %) bestehen aus bruchsicherem und schwer brennbarem Polycarbonat (Klassifizierung Brennbarkeit UL94 V-2), schließen bündig ab und schafft homogene LED Lichtverhältnisse mit hoher Verwertung der Lichtleistung. Passende PVC-Endkappen verschließen die seitlichen Öffnungen und schützen das Innenleben des TREPPEN-Profils.

GALAXY profiles
Perfect Light Lines

SP1 + C40



max.
13 mm

OEM

GALAXY profiles
Perfect Light Lines

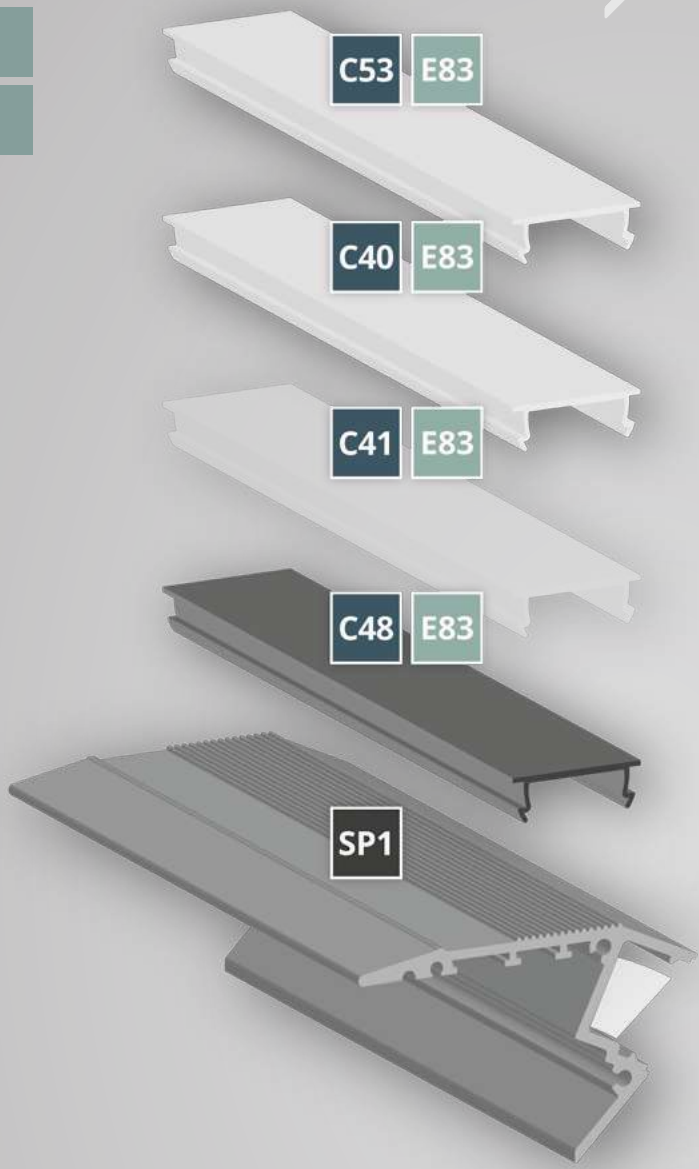
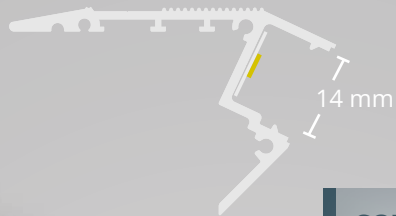

COVERS | ABDECKUNGEN

C40 65 %	200cm 8600085	250 cm 8600086	300 cm 8600087
C41 85 %	200cm 8600088	300cm 8600089	
C48 25 %	200cm 8600100	300cm 8600108	
C53 75 %	200cm 8600155	300cm 8600117	

END CAPS | ENDKAPPEN

E83	E83 8122151	E83 8122150
------------	----------------	----------------

PROFILE

SP1	200 cm 8122100
------------	-------------------

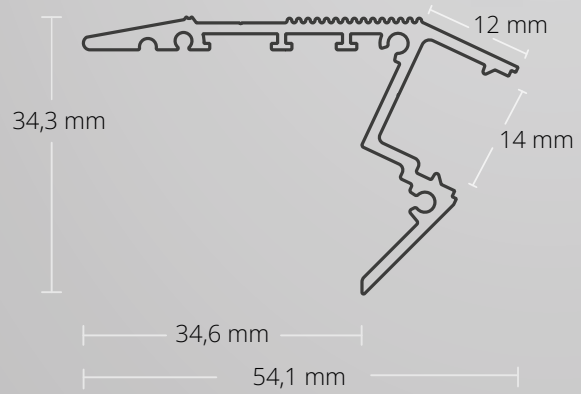



SP1 STAIR | TREPPE

LED Strips max. 13 mm
54,1 mm x 34,3 mm | 497 g/m

200 cm
8122100

max.
13 mm



OEM



COVERS | ABDECKUNGEN

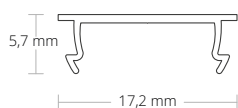

C40 opal | opal | 65 %

PC | 17,2 mm x 5,7 mm

200cm 250cm 300cm
8600085 **8600086** **8600087**

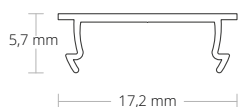

C41 clear | klar | 85 %

PC | 17,2 mm x 5,7 mm

200cm 300cm
8600088 **8600089**

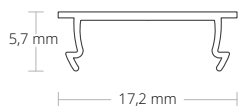

C48 black/matt | schwarz/matt | 25 %

PC | 17,2 mm x 5,7 mm

200cm 300cm
8600100 **8600108**

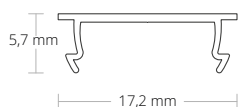

C53 white/matt | weiß/matt | 75 %

PC | 17,2 mm x 5,7 mm

200cm 300cm
8600155 **8600117**

END CAPS | ENDKAPPEN



E83 PETG | 2 PCS/STK

SET right + left | SET Rechts + Links

E83
8122151

SP2

STAIR | TREPPE

200 cm

max. 12 mm

OEM



EXTENSION OF SERVICE LIFE
VERLÄNGERUNG LEBENSDAUER

MECHANICAL PROTECTION
MECHANISCHER SCHUTZ

COOLING
KÜHLUNG

HIGH LIGHT UTILISATION
HOHE LICHTVERWERTUNG

HOMOGENEOUS LIGHT
HOMOGENES LICHT

HOMOGENEOUS LIGHT with modular LED light solutions

- Steps and stairs inside and out
Stufen und Treppen im Innen- und Outdoor-Bereich

Mounting/installation on/in wood Strips and plates, plasterboard, tiles, stone, granite, marble and metal surfaces
Montage/Einbau auf/in Holzleisten und -platten, Gipsplatten, Fliesen, Stein-, Granit-, Marmor- und Metalloberflächen



SP2

STAIR | TREPPE

LED Strips max. 12 mm

Silver/Silber
ANODIZED | ELOXIERT



max. 12 mm

max.
12 mm



OEM



Safe footing with effective lighting!

The SP2 profile can be used to illuminate stair edges and steps effectively. It is suitable for LED flex Strips with a maximum width of 12 mm and is available in anodised silver.

This stair profile is fixed either by screwing or gluing. An anti-slip milling provides additional safety when climbing stairs.

The SP2 profile is suitable in combination with Aquaflex tapes and for use in damp rooms and outdoors.

Sicherer Tritt mit effektvoller Beleuchtung!

Mit dem SP2 Profil lassen sich Treppenkanten und Stufen effektiv beleuchten. Es eignet sich für LED-Flexbänder mit einer maximalen Breite von 12 mm und es ist in eloxiertem Silber erhältlich.

Die Befestigung dieses Treppenprofils erfolgt entweder durch Anschrauben oder Ankleben. Eine Anti-Rutschfräsung sorgt für zusätzliche Sicherheit beim Treppensteigen.

Das SP2 Profil ist in Kombination mit Aquaflexbändern und für den Einsatz in Feuchträumen und im Freien geeignet.

GALAXY profiles
Perfect Light Lines

SP2 + C1

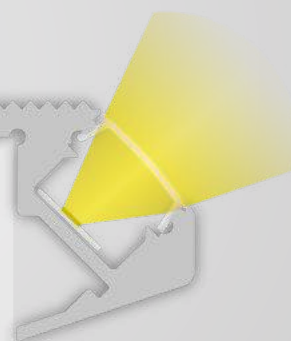

max.
12 mm

OEM

GALAXY profiles
Perfect Light Lines

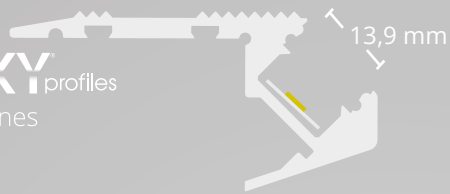

COVERS | ABDECKUNGEN

C1 65 %	200cm 8600004	250 cm 8600026	300 cm 8600080	600 cm 8600037
C2 85 %	200 cm 8600003	250 cm 8600135	300 cm 8600136	
C58 75 %	200 cm 8600154			
C32 25 %	200 cm 8600070	300 cm 8600103	600 cm 8600071	

END CAPS | ENDKAPPEN

E222	E222L 8304042	E222R 8304021
-------------	------------------	------------------

PROFILE

SP2	200 cm 8102092
------------	-------------------

LEFT
LINKS

END CAPS | ENDKAPPEN

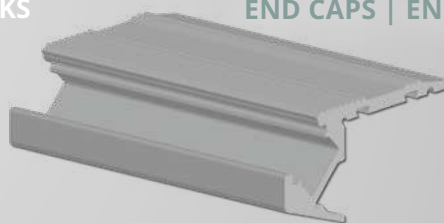

RIGHT
RECHTS

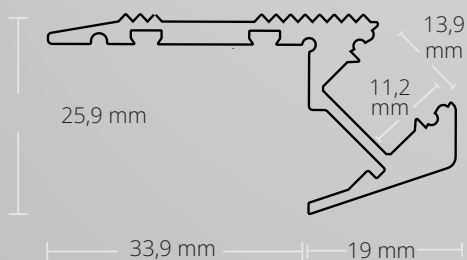
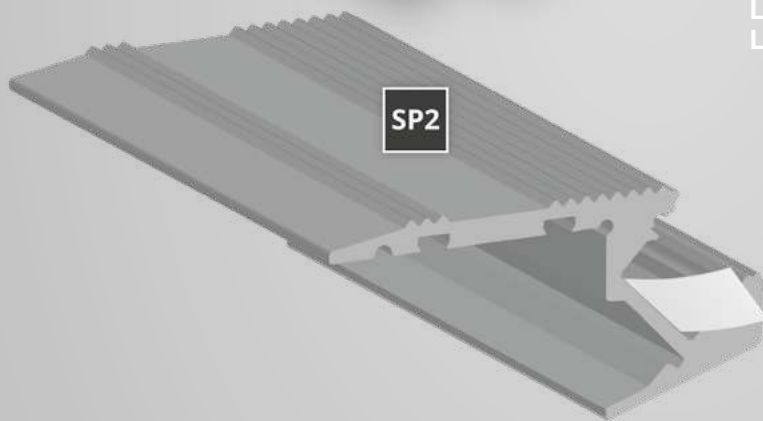



SP2 STAIR | TREPPE

LED Strips max. 12 mm
52,5 mm x 25,9 mm | 626 g/m

200 cm
8102092

max.
12 mm



OEM



COVERS | ABDECKUNGEN

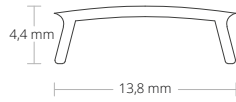

C1 opal | opal | 65 %

PC | 13,8 mm x 4,4 mm

200cm

8600004

250cm

8600026

300cm

8600080

600cm

8600037

C2 clear | klar | 85 %

PC | 13,8 mm x 4,4 mm

200cm

8600003

250cm

8600135

300cm

8600136

C58 white/matt | weiß/matt | 75 %

PC | 13,8 mm x 4,4 mm

200cm

8600154

C32 black/matt | schwarz/matt | 25 %

PC | 13,8 mm x 4,4 mm

200cm

8600070

300cm

8600103

600cm

8600071

END CAPS | ENDKAPPEN

E222 PETG | 1 PCS/STK

SET right + left | SET Rechts + Links



Left | Links

E222L

8304042



Right | Rechts

E222R

8304021

SF1

CLAMPING SYSTEM SPANNSYSTEM

1000cm | 2000 cm

max. 15 mm

 OEM

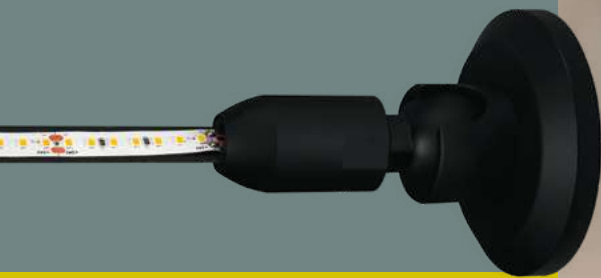

NEW TO OUR RANGE
IM SORTIMENT



EXTENSION OF SERVICE LIFE
VERLÄNGERUNG LEBENSDAUER

MECHANICAL PROTECTION
MECHANISCHER SCHUTZ

COOLING
KÜHLUNG

HIGH LIGHT UTILISATION
HOHE LICHTVERWERTUNG

HOMOGENEOUS LIGHT
HOMOGENES LICHT

HOMOGENEOUS LIGHT with modular LED light solutions

- Office | Büroräume
- Private area | Privatbereich
- Museums | Museen
- Churches | Kirchen
- Cellar vault | Kellergewölbe
- Rooms with vaulted ceilings
Räume mit gewölbter Decke
- Libraries | Bibliotheken
- Gastronomy | Gastronomie
- Hotel industry | Hotellerie
- Common rooms | Aufenthaltsräume
- Corridor, hallway, stairwell
Flur, Gang, Treppenhaus

Mounting on/in wood Strips and plates, plasterboard, tiles, stone, granite, marble and metal surfaces
Montage auf/in Holzleisten und -platten, Gipsplatten, Fliesen, Stein-, Granit-, Marmor- und Metalloberflächen



SF1

CLAMPING SYSTEM | SPANNSYSTEM

LED Strips max. 15 mm

Black / Schwarz
POWDER-COATED STAINLESS STEEL FLAT BELT
PULVERBESCHICHTETES EDELSTAHL-FLACHBAND

White / Weiß
POWDER-COATED STAINLESS STEEL FLAT BELT
PULVERBESCHICHTETES EDELSTAHL-FLACHBAND



max. 15 mm

max.
15 mm



OEM



With the SF1 clamping system, unique lines of light can be drawn across the room. The clamping system can simply be fixed to the wall and stretched from one corner to the other. The SF1 is a lighting solution that not only impresses with its flexibility, but also with its discreet appearance and exciting lighting effect.

The SF1 profile is ideal for realising creative lighting installations or for use in rooms with curved ceilings. The clamping system can be shortened to the desired length and therefore fits perfectly into any room. The profile is an intelligent lighting solution and creates a unique interplay of light and shadow, and you should ensure that it is adequately secured during installation, as the tensioned SF1 is subject to a high tensile force. Real eye-catchers can also be created in combination with the PO14 cover.

The choice of the appropriate mounting material is therefore of the utmost importance.

Mit dem SF1 Spannsystem lassen sich einzigartige Lichtlinien quer durch den Raum ziehen. Das Spannsystem kann einfach an der Wand befestigt und von der einen Ecke zur andere gespannt werden. Das SF1 ist eine Lichtlösung, die nicht nur mit Ihrer Flexibilität punktet, sondern auch mit einer dezenten Optik und einem spannenden Lichteffect.

Das SF1 Profil eignet sich bestens zur Verwirklichung kreativer Lichtinstallationen oder für den Einsatz in Räumen mit gewölbten Decken. Das Spannsystem lässt sich auf die gewünschte Länge kürzen und fügt sich somit in jeden Raum perfekt ein. Das Profil ist eine intelligente Beleuchtungslösung und sorgt für ein einzigartiges Licht-Schatten-Spiel. Auch in Kombination mit dem Cover PO14 lassen sich echte Hingucker erstellen.

Bei der Montage sollten sie auf eine ausreichende Befestigung achten, da auf das gespannte SF1 eine hohe Zugkraft wirkt. Die Wahl des entsprechenden Montage-materials ist daher von höchster Wichtigkeit.

GALAXY profiles
Perfect Light Lines



max.
15 mm

COVERS | ABDECKUNGEN

PO14 65% 200cm
8600045

PROFILE

SF1 1000 cm 8123398 2000 cm 8123400 1000 cm 8123399 2000 cm 8123432

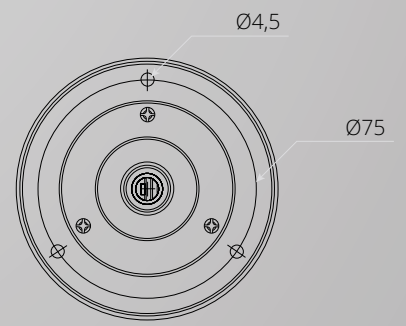
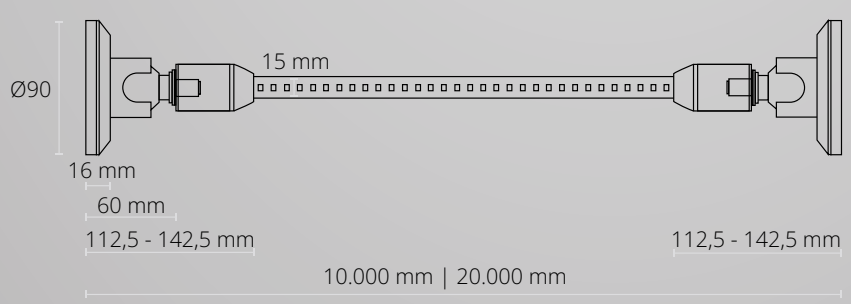
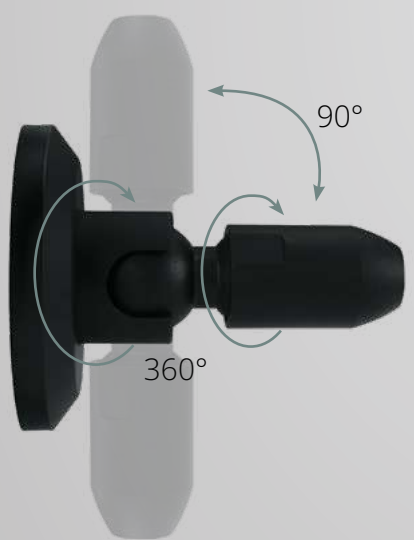
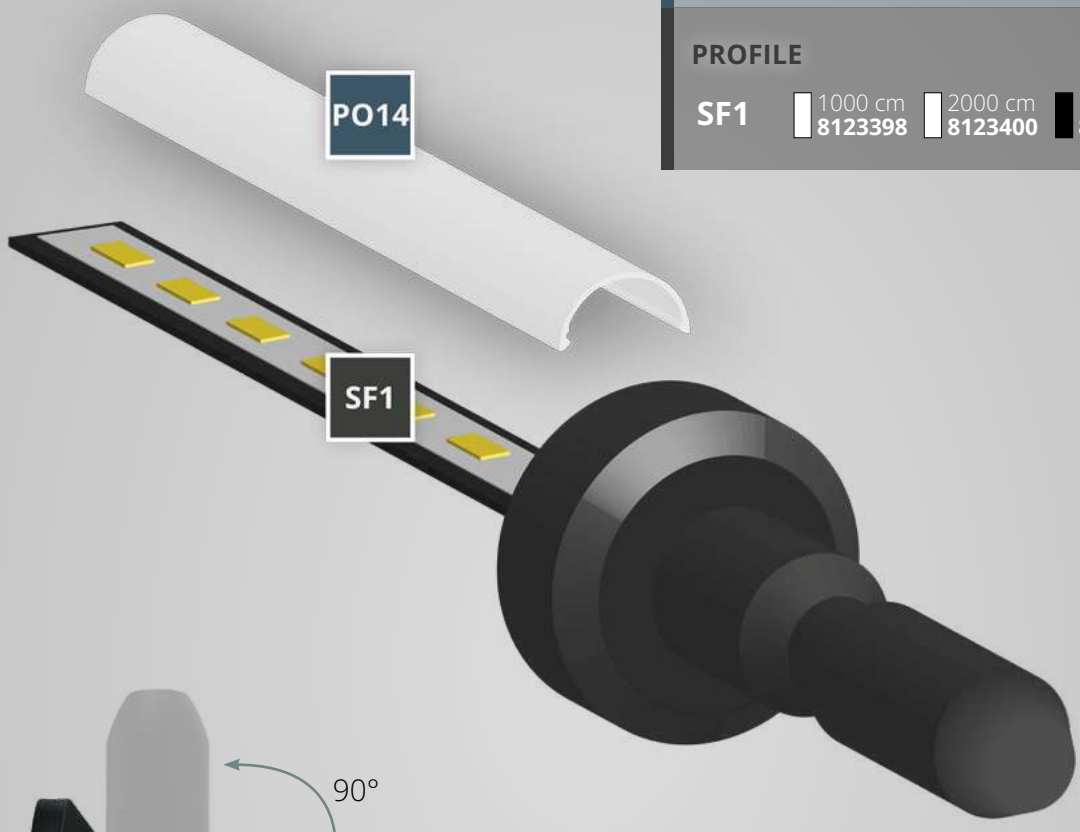



SF1 CLAMPING SYSTEM | SPANNSYSTEM

LED Strips max. 15 mm
52,5 mm x 25,9 mm | 626 g/m | Steel | Stahl

1000 cm 2000 cm 1000 cm 2000 cm
8123398 **8123400** **8123399** **8123432**

max.
15 mm



Z69
SET without steel band
SET ohne Stahlband
 8123448
 8123447

COVERS | ABDECKUNGEN

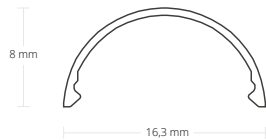

PO14 opal | opal | 65 %
PC | 16,3 mm x 8 mm
200cm
8600045

INDIRECT | INDIREKT



DIRECT | DIREKT



INSTALLATION INSTRUCTION
INSTALLATIONS MONTAGE



PLINTH TRAY



SOCKELSCHALE

BASE



BASIS

ROTARY AXIS
FLANGE



DREHACHSE
FLANSCH

MOUNTING BLOCK FOR
BATTEN LUMINAIRES



BEFESTIGUNGSBLOCK
FÜR LICHTLEISTEN

ROTARY AXIS



DREHACHSE

NL8

SURFACE | AUFBAU

200 cm | 250 cm | 300 cm

max. 14 mm

OEM

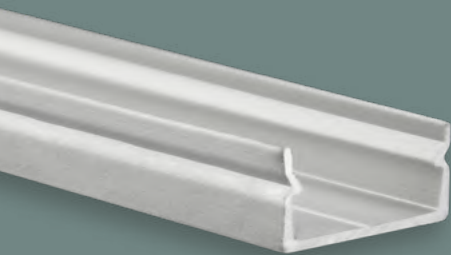

EXTENSION OF SERVICE LIFE
VERLÄNGERUNG LEBENSDAUER

MECHANICAL PROTECTION
MECHANISCHER SCHUTZ

COOLING
KÜHLUNG

HIGH LIGHT UTILISATION
HOHE LICHTVERWERTUNG

HOMOGENEOUS LIGHT
HOMOGENES LICHT

HOMOGENEOUS LIGHT with modular LED light solutions

- Wall, ceiling or floor mounting
Wand-, Decken- oder Bodenmontage
- Residential and office furniture
Wohn- und Büromöbel
- Furniture for business equipment
Möbel für Geschäftsausstattung
- Home accessories
Wohnaccessoires
- Mirrors | Spiegel
- Cabinet doors | Schranktüren
- Display cases | Vitrinen
- Shelves | Regale
- Stairs and railings
Treppenstufen und -Geländer
- Balustrades | Balustraden
- Façades, balconies and terraces
Fassaden, Balkone und Terrassen
- Living spaces | Wohnräume
- Offices | Büroräume
- Hotel and gastronomy business
Hotellerie und Gastronomie
- Retail (shop and showcase windows)
Einzelhandel (Shop- und Schaufenster)
- Business areas and showrooms
Geschäftsflächen und Showrooms
- Barber / Beauty / body art studios
Friseur-/Beauty-/Body-Art-Studios
- Halls, foyers and corridors
Hallen, Foyers und Flure
- Wellness and indoor leisure facilities
Wellness- und Indoor-Freizeitanlagen
- Wet rooms | Nasszellen

Mounting/installation on/in wood Strips and plates, plasterboard, tiles, stone, granite, marble and metal surfaces
Montage/Einbau auf/in Holzleisten und -platten, Gipsplatten, Fliesen, Stein-, Granit-, Marmor- und Metalloberflächen



NL8

SURFACE | AUFBAU

flach | flat | LED Strips max. 14 mm

 Silver/Silber
ANODIZED | ELOXIERT

 RAL 9010 White/Weiß
POWDER-COATED | PULVERBESCHICHTET

 RAL 9005 Black/Schwarz
POWDER-COATED | PULVERBESCHICHTET



max.14 mm

max.
14 mm



OEM



The NL8 LED SURFACE profile is available in standard lengths 200 cm, 250 cm and 300 cm. It is made of high-quality aluminium (anodised) and is designed for use both as a surface-mounted and recessed profile.

With the flat standard profile cover made of shatterproof and flame-retardant polycarbonate (flammability classification UL94 V-2) opal/satinised (translucency 65 %), clear (translucency 85 %) or black matt (translucency 25 %) , the aluminium profile is completely covered at the top, so only the LED light strip is visible. LED stripes with a max width of 14 mm can be glued in.

The NL8 LED SURFACE profile has a very low internal height of only 6.5 mm. Thanks to its small size and low weight, it is an ideal LED light source in home and office furniture, home accessories, showcases as well as on shelves, walls and ceilings.

Das NL8 LED AUFBAU-Profil ist standardmäßig in der Länge 200 cm, 250 cm und 300 cm verfügbar. Es ist aus hochwertigem Aluminium (eloxiert) gefertigt und für den Einsatz sowohl als AUFBAU- und EINBAU-Profil konzipiert.

Mit der flachen Standard-Profilabdeckung aus bruchsticherm und schwer brennbaren Polycarbonat (Klassifizierung Brennbarkeit UL94 V-2) Opal/satiniert (Lichtdurchlässigkeit 65 %), Klar (Lichtdurchlässigkeit 85 %) oder Schwarz Matt (Lichtdurchlässigkeit 25 %) wird das ALU-Profil oberseitig komplett abgedeckt, somit ist nur noch die LED Lichtleiste sichtbar. Es können LED Flexbänder mit einer max. Breite von 14 mm eingeklebt werden.

Das NL8 LED AUFBAU-Profil hat eine sehr geringe Innenhöhe von nur 6,5 mm. Aufgrund der kleinen Dimensionierung und des geringen Gewichtes ist es unter anderem sehr als ideale LED Lichtquelle in Wohn- und Büromöbeln, Wohnaccessoires, Vitrinen sowie an Regalen, Wänden und Decken geeignet.

GALAXY profiles
Perfect Light Lines



NL8 + C41



NL8 + C40



NL8 + C40

GALAXY profiles
Perfect Light Lines



max.
14 mm

OEM

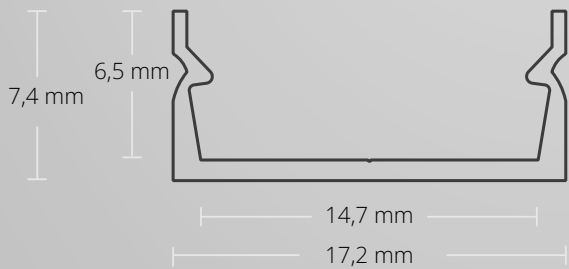
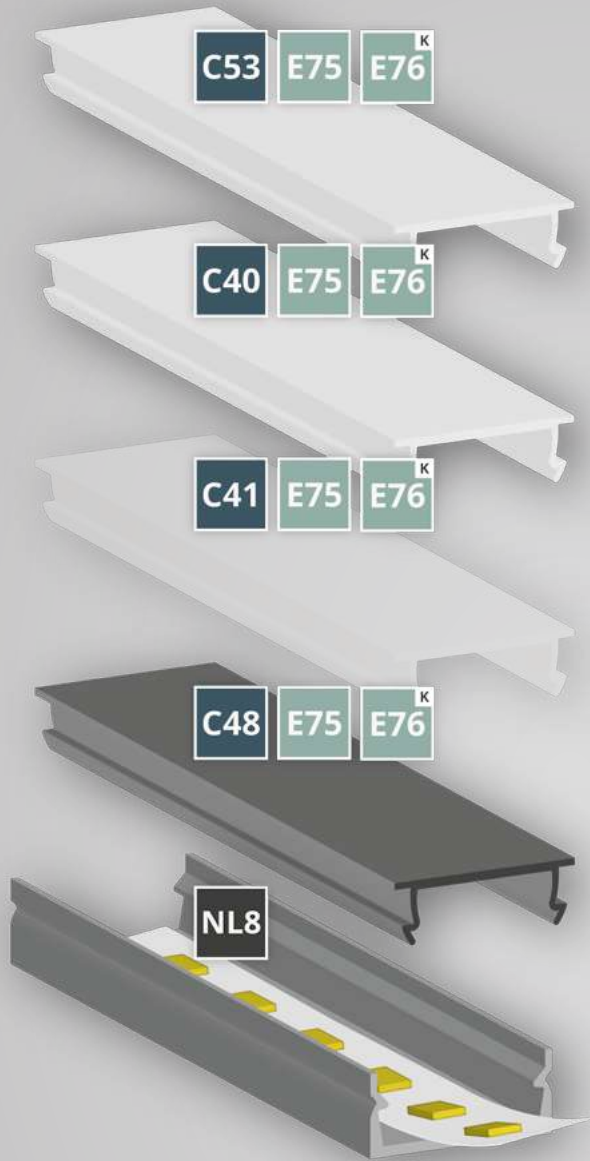

COVERS | ABDECKUNGEN

C40 65 % 200cm 8600085 250 cm 8600086 300 cm 8600087

C41 85 % 200cm 8600088 300cm 8600089

C48 25 % 200cm 8600100 300cm 8600108

C53 75 % 200cm 8600155 300cm 8600117

END CAPS | ENDKAPPEN

E75 E75 8121050 E75 8121052 E75 8121054

E76 E76 8121051 E76 8121053 E76 8121055

PROFILE

NL8 200 cm 8121000 200 cm 8121010 200 cm 8121020

250 cm 8121001

300 cm 8121002 300 cm 8121012 300 cm 8121022

Z31 8121040



NL8 SURFACE | AUFBAU

flach | flat | LED Strips max. 14 mm
17,2 mm x 7,4 mm | 68 g/m

200 cm **8121000** 200 cm **8121010** 200 cm **8121020**

250 cm **8121001**

300 cm **8121002** 300 cm **8121012** 300 cm **8121022**



Z31
Mounting Clips
Montageklammer
Sheet steel | Stahlblech
8121040

max.
14 mm

OEM

COVERS | ABDECKUNGEN

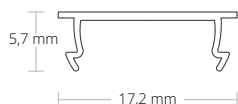

C40 opal | opal | 65 %
PC | 17,2 mm x 5,7 mm
200cm **8600085** 250cm **8600086** 300cm **8600087**

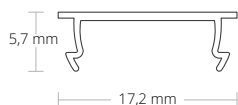

C41 clear | klar | 85 %
PC | 17,2 mm x 5,7 mm
200cm **8600088** 300cm **8600089**

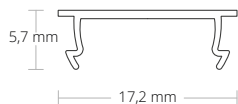

C48 black/matt | schwarz/matt | 25 %
PC | 17,2 mm x 5,7 mm
200cm **8600100** 300cm **8600108**

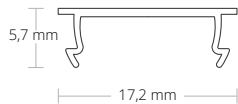

C53 white/matt | weiß/matt | 75 %
PC | 17,2 mm x 5,7 mm
200cm **8600155** 300cm **8600117**

END CAPS | ENDKAPPEN



E75 PVC | 1 PCS/STK
E75 **8121050** E75 **8121052** E75 **8121054**



E76 PVC | 1 PCS/STK | Cable/Kabel
E76 **8121051** E76 **8121053** E76 **8121055**

NL8F

RECESSED | EINBAU

200 cm | 300 cm

max. 14 mm

OEM



EXTENSION OF SERVICE LIFE
VERLÄNGERUNG LEBENSDAUER

MECHANICAL PROTECTION
MECHANISCHER SCHUTZ

COOLING
KÜHLUNG

HIGH LIGHT UTILISATION
HOHE LICHTVERWERTUNG

HOMOGENEOUS LIGHT
HOMOGENES LICHT

HOMOGENEOUS LIGHT with modular LED light solutions

- Wall, ceiling or floor mounting
Wand-, Decken- oder Bodenmontage
- Residential and office furniture
Wohn- und Büromöbel
- Furniture for business equipment
Möbel für Geschäftsausstattung
- Home accessories
Wohnaccessoires
- Mirrors | Spiegel
- Cabinet doors | Schranktüren
- Display cases | Vitrinen
- Shelves | Regale
- Stairs and railings
Treppenstufen und -Geländer
- Balustrades | Balustraden
- Façades, balconies and terraces
Fassaden, Balkone und Terrassen
- Living spaces | Wohnräume
- Offices | Büroräume
- Hotel and gastronomy business
Hotellerie und Gastronomie
- Retail (shop and showcase windows)
Einzelhandel (Shop- und Schaufenster)
- Business areas and showrooms
Geschäftsflächen und Showrooms
- Barber / Beauty / body art studios
Friseur-/Beauty-/Body-Art-Studios
- Halls, foyers and corridors
Hallen, Foyers und Flure
- Wellness and indoor leisure facilities
Wellness- und Indoor-Freizeitanlagen
- Wet rooms | Nasszellen

Mounting/installation on/in wood Strips and plates, plasterboard, tiles, stone, granite, marble and metal surfaces
Montage/Einbau auf/in Holzleisten und -platten, Gipsplatten, Fliesen, Stein-, Granit-, Marmor- und Metalloberflächen

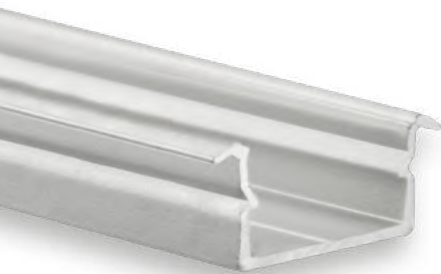

NL8F

RECESSED | EINBAU

flat/wings | flach/Flügel | LED Strips max. 14 mm

Silver/Silber
ANODIZED | ELOXIERT



max. 14 mm

max.
14 mm



OEM



The NL8F LED RECESSED profile has an especially narrow design, is designed for LED stripes with a maximum width of 14 mm and is used universally indoors.

The LED profile covers (opal/satinised (translucency 65 %), clear (translucency 85 %) or black matt (translucency 25 %)) are made of shatter-proof and flame-retardant polycarbonate (flammability classification UL94-2) and create homogeneous LED lighting conditions with high utilisation of the light output.

Covers also available in 2 m, 2.5 m and 3 m!

Thanks to their small size and low weight these LED RECESSED profiles can be recessed almost invisibly in walls and ceilings with plaster, stone or concrete slabs as well as wood panelling.

They can also be installed in pre-milled furniture. They are therefore ideal LED light sources in home and office furniture, home accessories, showcases, shelves, on steps and of course on walls and ceilings.

Das NL8F LED EINBAU-Profil hat ein besonders schmales Design, ist für LED Flexbänder mit einer maximalen Breite von 14 mm konzipiert und wird universell im Innenbereich eingesetzt.

Die LED Profilabdeckungen Opal/satiniert (Lichtdurchlässigkeit 65 %), Klar (Lichtdurchlässigkeit 85 %) oder Schwarz Matt (Lichtdurchlässigkeit 25 %) bestehen aus bruchsicherem und schwer brennbarem Polycarbonat (Klassifizierung Brennbarkeit UL94 V-2) und schaffen homogene LED Lichtverhältnisse mit hoher Verwertung der Lichtleistung.

Abdeckungen auch in 2 m, 2,5 m und 3 m verfügbar!

Diese LED EINBAU-Profile werden aufgrund ihrer kleinen Abmessungen und des geringen Gewichtes in Wänden und Decken mit Gips-, Stein- oder Betonplatten sowie Holzverkleidungen kaum sichtbar versenkt.

Sie können auch in vorgefräste Möbel installiert werden. Sie sind somit ideale LED Lichtquellen in Wohn- und Büromöbeln, Wohnaccessoires, Vitrinen, Regalen, an Treppenstufen und selbstverständlich an Wänden und Decken.

GALAXY profiles
Perfect Light Lines

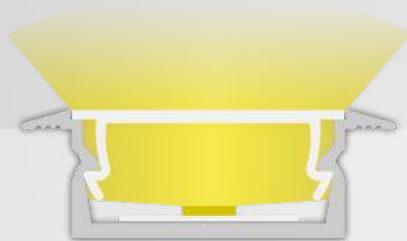

NL8F + C40

max.
14 mm

OEM



GALAXY profiles
Perfect Light Lines

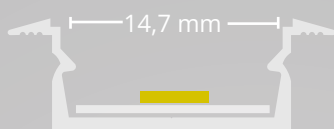

COVERS | ABDECKUNGEN

C40 65 %	200cm 8600085	250 cm 8600086	300 cm 8600087
C41 85 %	200cm 8600088	300cm 8600089	
C48 25 %	200cm 8600100	300cm 8600108	
C53 75 %	200cm 8600155	300cm 8600117	

END CAPS | ENDKAPPEN

E79	E79 8121250
E80	E80 8121251

PROFILE

NL8F	200 cm 8121200	300 cm 8121202
	Z31 8121040	

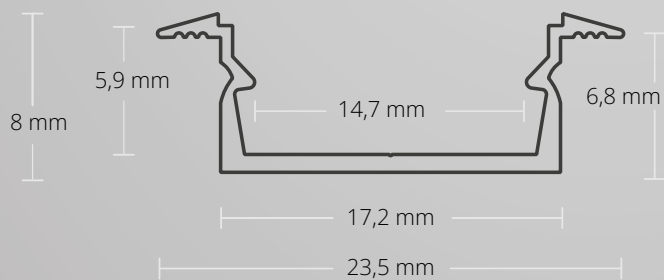

NL8F RECESSED | EINBAU

flat/wings | flach/Flügel | LED Strips max. 14 mm
23,5 mm x 8 mm | 79 g/m

200 cm
8121200

300 cm
8121202



Z31

Mounting Clips

Montageklammer

Sheet steel | Stahlblech

8121040

max.
14 mm



OEM



COVERS | ABDECKUNGEN

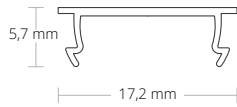

C40 opal | opal | 65 %

PC | 17,2 mm x 5,7 mm

200cm 250cm 300cm
8600085 8600086 8600087

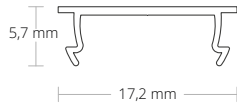

C41 clear | klar | 85 %

PC | 17,2 mm x 5,7 mm

200cm 300cm
8600088 8600089

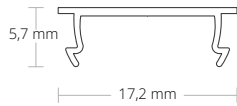

C48 black/matt | schwarz/matt | 25 %

PC | 17,2 mm x 5,7 mm

200cm 300cm
8600100 8600108

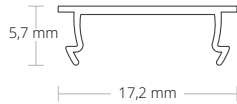

C53 white/matt | weiß/matt | 75 %

PC | 17,2 mm x 5,7 mm

200cm 300cm
8600155 8600117

END CAPS | ENDKAPPEN



E79 PVC | 1 PCS/STK

E79
8121250



E80 PVC | 1 PCS/STK | Cable/Kabel

E80
8121251

NL15

SURFACE | AUFBAU

200 cm | 300 cm

max. 12 mm

OEM

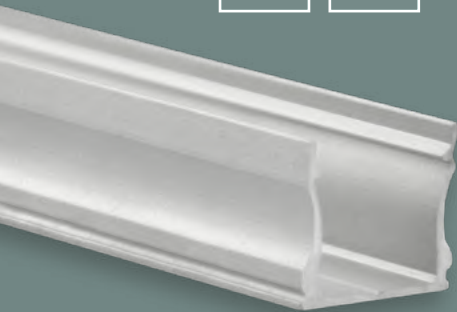

EXTENSION OF SERVICE LIFE
VERLÄNGERUNG LEBENSDAUER

MECHANICAL PROTECTION
MECHANISCHER SCHUTZ

COOLING
KÜHLUNG

HIGH LIGHT UTILISATION
HOHE LICHTVERWERTUNG

HOMOGENEOUS LIGHT
HOMOGENES LICHT

HOMOGENEOUS LIGHT with modular LED light solutions

- Wall, ceiling or floor mounting
Wand-, Decken- oder Bodenmontage
- Residential and office furniture
Wohn- und Büromöbel
- Furniture for business equipment
Möbel für Geschäftsausstattung
- Home accessories
Wohnaccessoires
- Mirrors | Spiegel
- Cabinet doors | Schranktüren
- Display cases | Vitrinen
- Shelves | Regale
- Stairs and railings
Treppenstufen und -Geländer
- Balustrades | Balustraden
- Façades, balconies and terraces
Fassaden, Balkone und Terrassen
- Living spaces | Wohnräume
- Offices | Büroräume
- Hotel and gastronomy business
Hotellerie und Gastronomie
- Retail (shop and showcase windows)
Einzelhandel (Shop- und Schaufenster)
- Business areas and showrooms
Geschäftsflächen und Showrooms
- Barber / Beauty / body art studios
Friseur-/Beauty-/Body-Art-Studios
- Halls, foyers and corridors
Hallen, Foyers und Flure
- Wellness and indoor leisure facilities
Wellness- und Indoor-Freizeitanlagen
- Wet rooms | Nasszellen

Mounting/installation on/in wood Strips and plates, plasterboard, tiles, stone, granite, marble and metal surfaces
Montage/Einbau auf/in Holzleisten und -platten, Gipsplatten, Fliesen, Stein-, Granit-, Marmor- und Metalloberflächen



NL15

SURFACE | AUFBAU

hoch | high | LED Strips max. 12 mm

 Silver/Silber
ANODIZED | ELOXIERT

 RAL 9010 White/Weiß
POWDER-COATED | PULVERBESCHICHTET

 RAL 9005 Black/Schwarz
POWDER-COATED | PULVERBESCHICHTET



max. 12 mm

**max.
12 mm**



OEM



The NL15 LED SURFACE profile is available in standard lengths of 200 cm and 300 cm and is made of high-quality aluminium (anodised). It is designed for use both as a surface-mounted and installed profile.

With the flat standard profile cover made of shatterproof and flame-retardant polycarbonate (flammability classification UL94 V-2) opal/satinised (translucency 65 %), clear (translucency 85 %) or black matt (translucency 25 %), the aluminium profile is completely covered at the top, so only the LED light strip is visible. LED stripes with a max width of 12 mm can be glued in.

Special feature: the cover is flush with the profile. This means only the LED light strip remains visible.

This LED profile also has a larger heat sink due to its greater internal height compared to the NL8 LED SURFACE profile and can thus be equipped with stronger LED stripes without having to do without homogeneous LED light lines (no light points but continuous light line).

Thanks to its small size and low weight, this LED profile system is an ideal LED light source in home and office furniture, home accessories, showcases, shelves as well as on stairs and of course on walls and ceilings.

Das NL15 LED AUFBAU-Profil ist standardmäßig in der Länge 200 cm und 300 cm verfügbar und ist aus hochwertigem Aluminium (eloxiert) gefertigt. Es ist für den Einsatz sowohl als AUFBAU- und EINBAU-Profil konzipiert.

Mit der flachen Standard-Profilabdeckung aus bruchsicherem und schwer brennbarem Polycarbonat (Klassifizierung Brennbarkeit UL94 V-2) Opal/satiniert (Lichtdurchlässigkeit 65 %), Klar (Lichtdurchlässigkeit 85 %) oder Schwarz Matt (Lichtdurchlässigkeit 25 %) wird das ALU-Profil oberseitig komplett abgedeckt, somit ist nur noch die LED Lichtleiste sichtbar. Es können LED Flexbänder mit einer max. Breite von 12 mm eingeklebt werden.

Besonderheit: die Abdeckung schließt bündig mit dem Profil ab. Somit ist nur noch die LED Lichtleiste sichtbar.

Dieses LED Profil hat aufgrund seiner im Vergleich zum NL8 LED AUFBAU-Profil größeren Innenhöhe auch einen größeren Kühlkörper und kann somit mit stärkeren LED Flexbändern bestückt werden, ohne dabei auf homogene LED Lichtlinien verzichten zu müssen (keine Lichtpunkte, sondern durchgängige Lichtlinie).

Wegen der kleinen Abmessungen und des geringen Gewichtes ist dieses Profilsystem unter anderem als ideale LED Lichtquelle in Wohn- und Büromöbeln, Wohnaccessoires, Vitrinen, Regalen sowie an Treppenstufen und selbstverständlich an Wänden und Decken geeignet.

GALAXY profiles
Perfect Light Lines



NL15 + C40



NL15 + C41

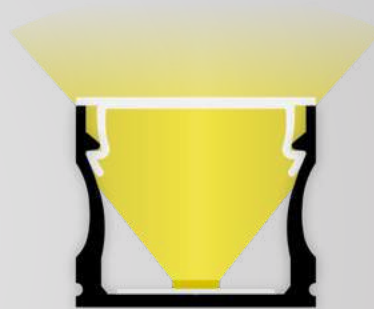

NL15 + C40

- max. 12 mm
- OEM

GALAXY profiles
Perfect Light Lines

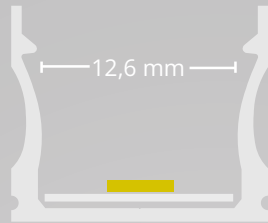

COVERS | ABDECKUNGEN

C40 65 %	200cm 8600085	250 cm 8600086	300 cm 8600087
C41 85 %	200cm 8600088	300cm 8600089	
C48 25 %	200cm 8600100	300cm 8600108	
C53 75 %	200cm 8600155	300cm 8600117	

END CAPS | ENDKAPPEN

E77	E77 8121150	E77 8121152	E77 8121154
E78	E78 8121151	E78 8121153	E78 8121155

PROFILE

NL15	200 cm 8121100	200 cm 8121110	200 cm 8121120
	300 cm 8121102	300 cm 8121112	300 cm 8121122
	Z31 8121040		

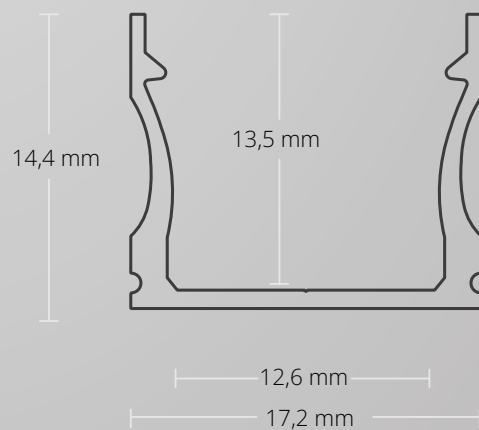



NL15 SURFACE | AUFBAU

high | hoch | LED Strips max. 12 mm
17,2 mm x 14,4 mm | 118 g/m

- 200 cm 8121100
- 200 cm 8121110
- 200 cm 8121120
- 300 cm 8121102
- 300 cm 8121112
- 300 cm 8121122



Z31
Mounting Clips
Montageklammer
Sheet Steel | Stahlblech
8121040

max. 12 mm

OEM

COVERS | ABDECKUNGEN

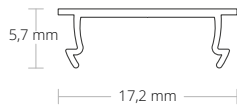

C40 opal | opal | 65 %
PC | 17,2 mm x 5,7 mm
200cm 250cm 300cm
8600085 8600086 8600087

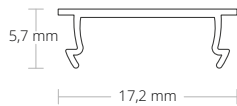

C41 clear | klar | 85 %
PC | 17,2 mm x 5,7 mm
200cm 300cm
8600088 8600089

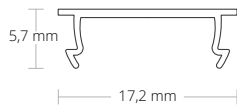

C48 black/matt | schwarz/matt | 25 %
PC | 17,2 mm x 5,7 mm
200cm 300cm
8600100 8600108

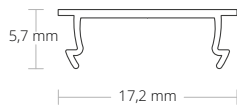

C53 white/matt | weiß/matt | 75 %
PC | 17,2 mm x 5,7 mm
200cm 300cm
8600155 8600117

END CAPS | ENDKAPPEN



E77 PVC | 1 PCS/STK
E77 8121150 E77 8121152 E77 8121154



E78 PVC | 1 PCS/STK | Cable/Kabel
E78 8121151 E78 8121153 E78 8121155

NL15F

RECESSED | EINBAU

200 cm | 300 cm

max. 12 mm

OEM

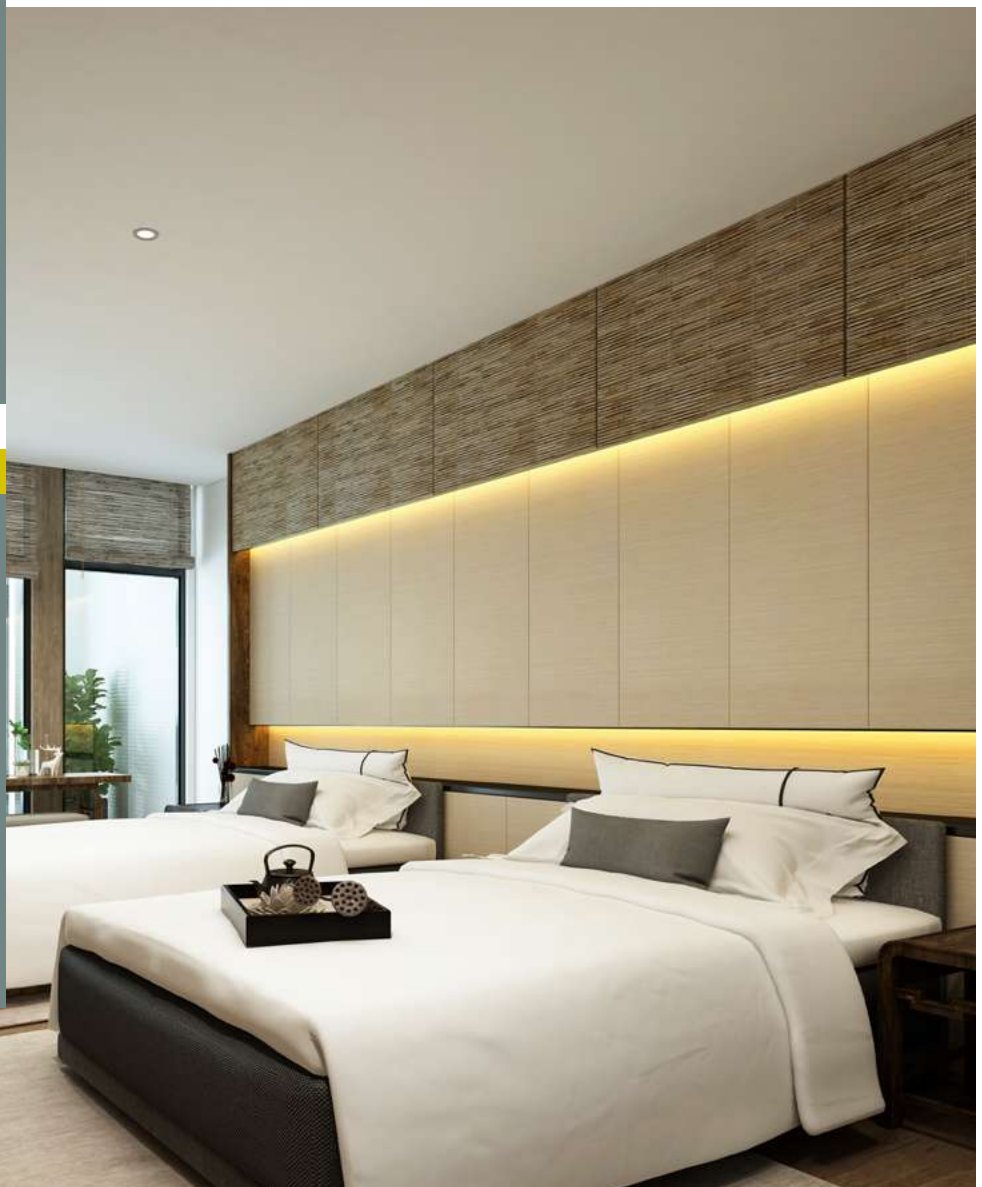
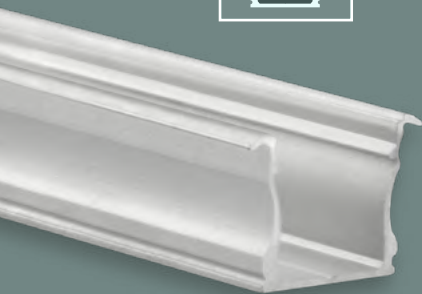

EXTENSION OF SERVICE LIFE
VERLÄNGERUNG LEBENSDAUER

MECHANICAL PROTECTION
MECHANISCHER SCHUTZ

COOLING
KÜHLUNG

HIGH LIGHT UTILISATION
HOHE LICHTVERWERTUNG

HOMOGENEOUS LIGHT
HOMOGENES LICHT

HOMOGENEOUS LIGHT with modular LED light solutions

- Wall, ceiling or floor mounting
Wand-, Decken- oder Bodenmontage
- Residential and office furniture
Wohn- und Büromöbel
- Furniture for business equipment
Möbel für Geschäftsausstattung
- Home accessories
Wohnaccessoires
- Mirrors | Spiegel
- Cabinet doors | Schranktüren
- Display cases | Vitrinen
- Shelves | Regale
- Stairs and railings
Treppenstufen und -Geländer
- Balustrades | Balustraden
- Façades, balconies and terraces
Fassaden, Balkone und Terrassen
- Living spaces | Wohnräume
- Offices | Büroräume
- Hotel and gastronomy business
Hotellerie und Gastronomie
- Retail (shop and showcase windows)
Einzelhandel (Shop- und Schaufenster)
- Business areas and showrooms
Geschäftsflächen und Showrooms
- Barber / Beauty / body art studios
Friseur-/Beauty-/Body-Art-Studios
- Halls, foyers and corridors
Hallen, Foyers und Flure
- Wellness and indoor leisure facilities
Wellness- und Indoor-Freizeitanlagen
- Wet rooms | Nasszellen

Mounting/installation on/in wood Strips and plates, plasterboard, tiles, stone, granite, marble and metal surfaces
Montage/Einbau auf/in Holzleisten und -platten, Gipsplatten, Fliesen, Stein-, Granit-, Marmor- und Metalloberflächen



NL15F

RECESSED | EINBAU

high/wings | hoch/Flügel | LED Strips max. 12 mm

Silver/Silber
ANODIZED | ELOXIERT



max. 12 mm

max.
12 mm



OEM



The NL15F LED RECESSED profile has an especially narrow design, is designed for LED stripes with a maximum width of 12 mm and is used universally indoors.

The LED profile covers (opal/satinised (translucency 65 %), clear (translucency 85 %) or black matt (translucency 25 %)) are made of shatter-proof and flame-retardant polycarbonate (flammability classification UL94-2) and create homogeneous LED lighting conditions with high utilisation of the light output.

Covers also available in 2 m, 2.5 m and 3 m!

This LED profile also has a larger heat sink due to its greater internal height compared to the NL8F LED SURFACE MOUNT profile and can thus be equipped with stronger LED stripes without having to do without homogeneous LED light lines (no light points but continuous light line).

Thanks to its small size and low weight this profile can be recessed almost invisibly in walls and ceilings with plaster, stone or concrete slabs as well as wood panelling.

They can also be installed in pre-milled furniture. They are therefore ideal LED light sources in home and office furniture, home accessories, showcases, shelves, on steps and of course on walls and ceilings.

Das NL15F LED EINBAU-Profil hat ein besonders schmales Design, ist für LED Flexbänder mit einer maximalen Breite von 12 mm konzipiert und wird universell im Innenbereich eingesetzt.

Die LED Profilabdeckungen Opal/satiniert (Lichtdurchlässigkeit 65 %), Klar (Lichtdurchlässigkeit 85 %) oder Schwarz Matt (Lichtdurchlässigkeit 25 %) bestehen aus bruchsicherem und schwer brennbarem Polycarbonat (Klassifizierung Brennbarkeit UL94 V-2) und schaffen homogene LED Lichtverhältnisse mit hoher Verwertung der Lichtleistung.

Abdeckungen auch in 2 m, 2,5 m und 3 m verfügbar!

Dieses LED Profil hat aufgrund seiner im Vergleich zum NL8F LED AUFBAU-Profil größeren Innenhöhe auch einen größeren Kühlkörper und kann somit mit stärkeren LED Flexbändern bestückt werden, ohne dabei auf homogene LED Lichtlinien verzichten zu müssen (keine Lichtpunkte, sondern durchgängige Lichtlinie).

Das Profil kann aufgrund der kleinen Abmessungen und des geringen Gewichtes in Wänden und Decken mit Gips-, Stein- oder Betonplatten sowie Holzverkleidungen kaum sichtbar versenkt werden.

Sie können auch in vorgefräste Möbel installiert werden. Sie sind somit ideale LED Lichtquellen in Wohn- und Büromöbeln, Wohnaccessoires, Vitrinen, Regalen, an Treppenstufen und selbstverständlich an Wänden und Decken.

GALAXY profiles
Perfect Light Lines

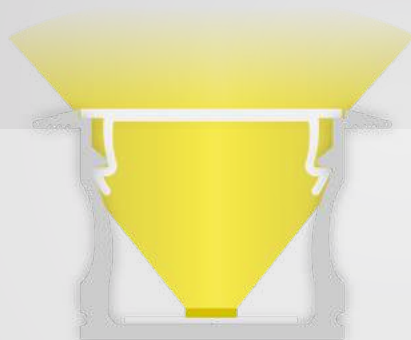

NL15F + C40

max.
12 mm

OEM

GALAXY profiles
Perfect Light Lines

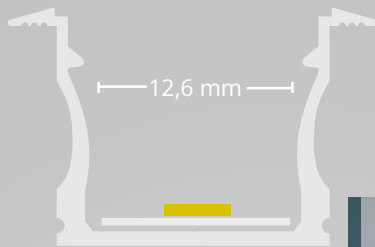

COVERS | ABDECKUNGEN

C40 65 %	200cm 8600085	250 cm 8600086	300 cm 8600087
C41 85 %	200cm 8600088	300cm 8600089	
C48 25 %	200cm 8600100	300cm 8600108	
C53 75 %	200cm 8600155	300cm 8600117	

END CAPS | ENDKAPPEN

E85	E85 8121350
E86	E86 8121351

PROFILE

NL15F	200 cm 8121300	300 cm 8121302
	Z31 8121040	

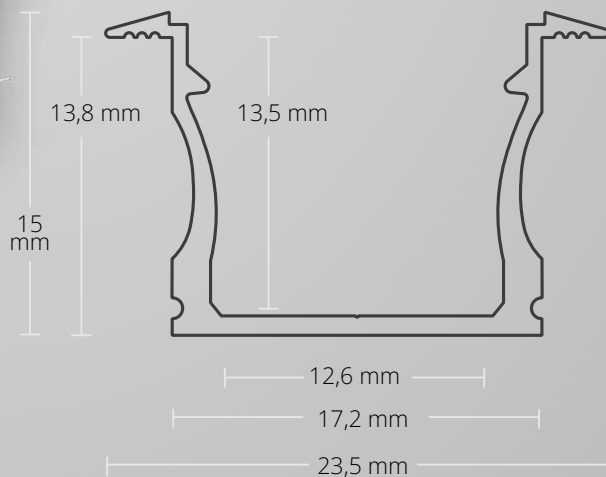



NL15F RECESSED | EINBAU

high/wings | hoch/Flügel | LED Strips max. 12 mm
23,5 mm x 15 mm | 132 g/m

200 cm
8121300

300 cm
8121302



Z31

Mounting Clips
Montageklammer
Sheet steel | Stahlblech
8121040

max.
12 mm



OEM



COVERS | ABDECKUNGEN

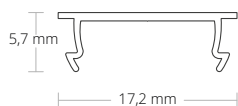

C40 opal | opal | 65 %

PC | 17,2 mm x 5,7 mm

200cm 250cm 300cm
8600085 8600086 8600087

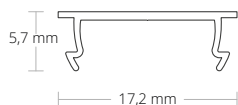

C41 clear | klar | 85 %

PC | 17,2 mm x 5,7 mm

200cm 300cm
8600088 8600089

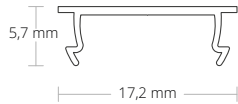

C48 black/matt | schwarz/matt | 25 %

PC | 17,2 mm x 5,7 mm

200cm 300cm
8600100 8600108



C53 white/matt | weiß/matt | 75 %

PC | 17,2 mm x 5,7 mm

200cm 300cm
8600155 8600117

END CAPS | ENDKAPPEN



E85 PVC | 1 PCS/STK

E85
8121350



E86 PVC | 1 PCS/STK | Cable/Kabel

E86
8121351

NL10

CORNER | ECK

200 cm | 300 cm

max. 10 mm

OEM



EXTENSION OF SERVICE LIFE
VERLÄNGERUNG LEBENSDAUER

MECHANICAL PROTECTION
MECHANISCHER SCHUTZ

COOLING
KÜHLUNG

HIGH LIGHT UTILISATION
HOHE LICHTVERWERTUNG

HOMOGENEOUS LIGHT
HOMOGENES LICHT

HOMOGENEOUS LIGHT with modular LED light solutions

- Wall, ceiling or floor mounting
Wand-, Decken- oder Bodenmontage
- Residential and office furniture
Wohn- und Büromöbel
- Furniture for business equipment
Möbel für Geschäftsausstattung
- Home accessories
Wohnaccessoires
- Mirrors | Spiegel
- Cabinet doors | Schranktüren
- Display cases | Vitrinen
- Shelves | Regale
- Stairs and railings
Treppenstufen und -Geländer
- Balustrades | Balustraden
- Façades, balconies and terraces
Fassaden, Balkone und Terrassen
- Living spaces | Wohnräume
- Offices | Büroräume
- Hotel and gastronomy business
Hotellerie und Gastronomie
- Retail (shop and showcase windows)
Einzelhandel (Shop- und Schaufenster)
- Business areas and showrooms
Geschäftsflächen und Showrooms
- Barber / Beauty / body art studios
Friseur-/Beauty-/Body-Art-Studios
- Halls, foyers and corridors
Hallen, Foyers und Flure
- Wellness and indoor leisure facilities
Wellness- und Indoor-Freizeitanlagen
- Wet rooms | Nasszellen

Mounting/installation on/in wood Strips and plates, plasterboard, tiles, stone, granite, marble and metal surfaces
Montage/Einbau auf/in Holzleisten und -platten, Gipsplatten, Fliesen, Stein-, Granit-, Marmor- und Metalloberflächen



NL10

CORNER | ECK

LED Strips max. 10 mm

Silver/Silber
ANODIZED | ELOXIERT

max.
10 mm



OEM



NL10 LED CORNER profile is designed for LED flexstrips with a maximum width of 10 mm and is universally used in interior areas.

The LED profile cover opal/satinised (translucency 65 %) is made of shatter-proof, non-flammable polycarbonate (classification flammability UL94 V-2) and create homogeneous LED lighting conditions with high utilisation of the light output (no pinpoints of light, but rather continuous lines of light).

The NL10 LED CORNER profile is dimensioned extremely small and is ideally suited as a LED light source in residential and office furniture, home accessories, display cases, shelves as well as on stairs, walls and ceilings, among other things, due to its low weight.

Das NL10 LED ECK-Profil ist für LED Flexbänder mit einer maximalen Breite von 10 mm konzipiert und wird universell im Innenbereich eingesetzt.

Die LED Profilabdeckung Opal/satiniert (Lichtdurchlässigkeit 65 %) besteht aus bruchsicherem und schwer brennbarem Polycarbonat (Klassifizierung Brennbarkeit UL94 V-2) und schafft homogene LED Lichtverhältnisse mit hoher Verwertung der Lichtleistung (keine Lichtpunkte, sondern durchgängige Lichtlinie).

Das NL10 LED ECK-Profil ist ultraklein dimensioniert und aufgrund des geringen Gewichtes unter anderem als ideale LED Lichtquelle in Wohn- und Büromöbeln, Wohnaccessoires, Vitrinen, Regalen sowie an Treppenstufen, Wänden und Decken geeignet.

GALAXY profiles
Perfect Light Lines

NL10 + C49

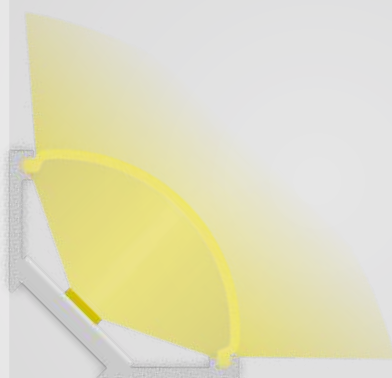

max.
10 mm

OEM



GALAXY profiles
Perfect Light Lines

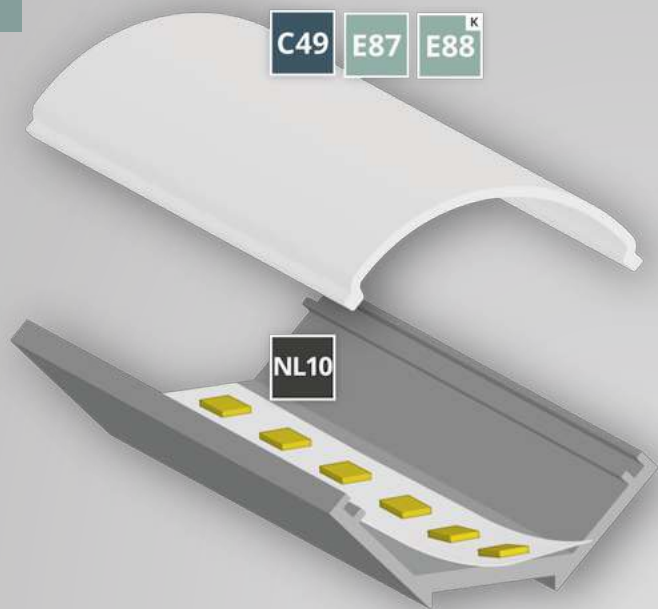
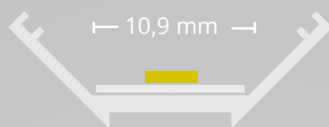

COVERS | ABDECKUNGEN

C49 65 % 200cm 300cm
8600101 8600102

END CAPS | ENDKAPPEN

E87 E87
8121450

E88 E88
8121451

PROFILE

NL10 200 cm 300 cm
8121400 8121402

Z38
8121460

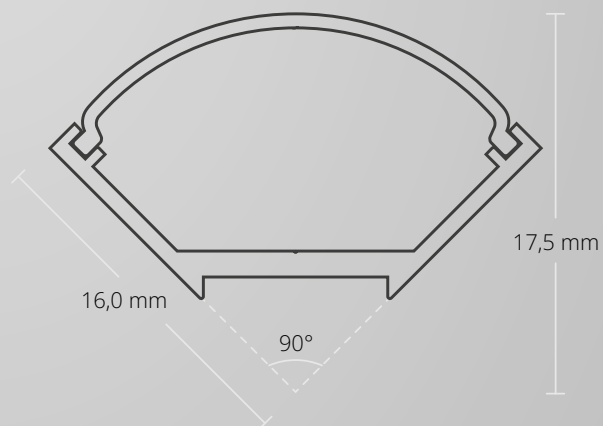
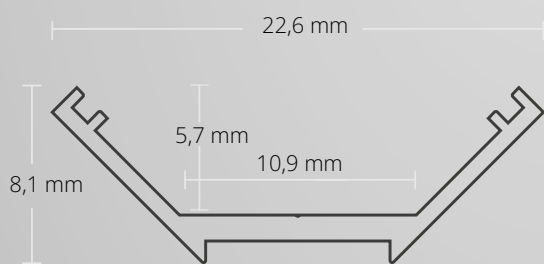

NL10 CORNER | ECK

LED Strips max. 10 mm
22,6 mm x 8,1 mm | 57 g/m

200 cm
8121400

300 cm
8121402



Z38

Mounting Clips
Montageklammer
Sheet steel | Stahlblech
8121460



max.
10 mm



OEM



C49 opal | opal | 65 %
PC | 20,8 mm x 6,3 mm
200cm 300cm
8600101 8600102

END CAPS | ENDKAPPEN



E87 PVC | 1 PCS/STK
E87
8121450



E88 PVC | 1 PCS/STK | Cable/Kabel
E88
8121451

VA1

SURFACE/LUMINAIRE |
AUFBAU/LEUCHTEN

200 cm

max. 16 mm

OEM

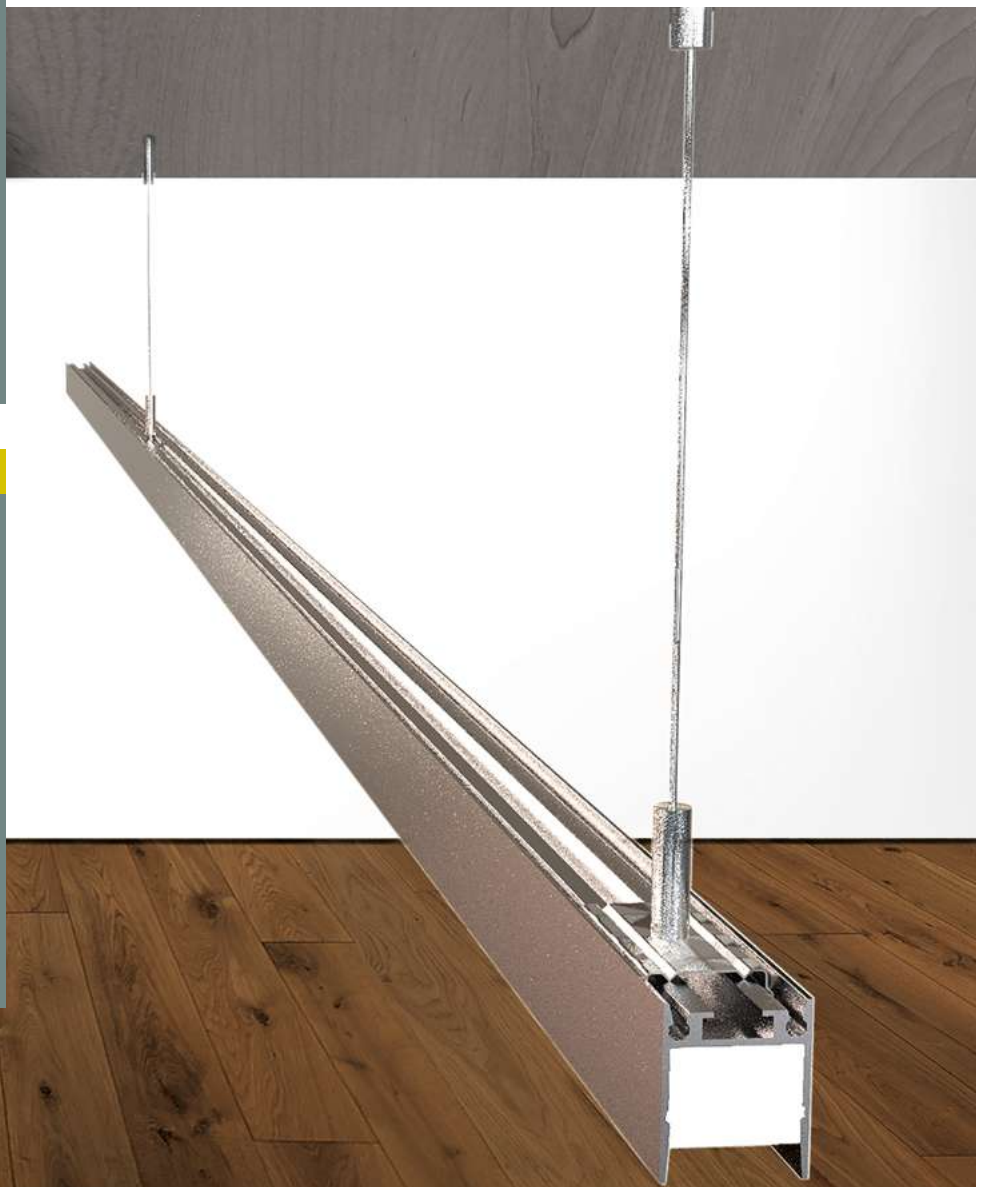
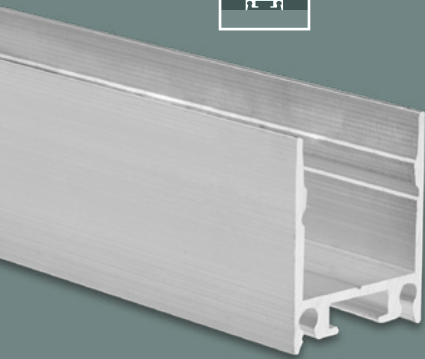

EXTENSION OF SERVICE LIFE
VERLÄNGERUNG LEBENSDAUER

MECHANICAL PROTECTION
MECHANISCHER SCHUTZ

COOLING
KÜHLUNG

HIGH LIGHT UTILISATION
HOHE LICHTVERWERTUNG

HOMOGENEOUS LIGHT
HOMOGENES LICHT

HOMOGENEOUS LIGHT with modular LED light solutions

- Wall, ceiling or floor mounting
Wand-, Decken- oder Bodenmontage
- Residential and office furniture
Wohn- und Büromöbel
- Furniture for business equipment
Möbel für Geschäftsausstattung
- Home accessories
Wohnaccessoires
- Mirrors | Spiegel
- Cabinet doors | Schranktüren
- Display cases | Vitrinen
- Shelves | Regale
- Balustrades | Balustraden
- Façades, balconies and terraces
Fassaden, Balkone und Terrassen
- Living spaces | Wohnräume
- Offices | Büroräume
- Hotel and gastronomy business
Hotellerie und Gastronomie
- Retail (shop and showcase windows)
Einzelhandel (Shop- und Schaufenster)
- Business areas and showrooms
Geschäftsflächen und Showrooms
- Barber / Beauty / body art studios
Friseur-/Beauty-/Body-Art-Studios
- Halls, foyers and corridors
Hallen, Foyers und Flure
- Wellness and indoor leisure facilities
Wellness- und Indoor-Freizeitanlagen
- Wet rooms | Nasszellen

Mounting/installation on/in wood Strips and plates, plasterboard, tiles, stone, granite, marble and metal surfaces
Montage/Einbau auf/in Holzleisten und -platten, Gipsplatten, Fliesen, Stein-, Granit-, Marmor- und Metalloberflächen

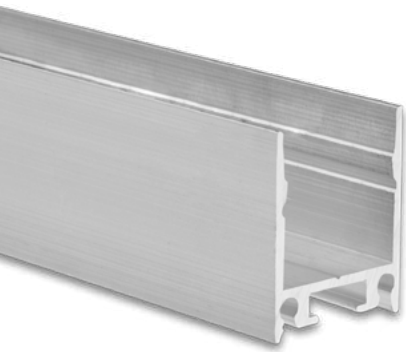

VA1

SURFACE/LUMINAIRE | AUFBAU/LEUCHTEN

LED Strips max. 16 mm

 Silver/Silber
ANODIZED | ELOXIERT

 RAL 9010 White/Weiß
POWDER-COATED | PULVERBESCHICHTET

 RAL 9005 Black/Schwarz
POWDER-COATED | PULVERBESCHICHTET



max. 16 mm



The VA1 LED PROFILE FOR INDIRECT LIGHTING has a standard length of 200cm and is made of high quality aluminum (anodized). Due to the recessed cover, you can achieve indirect and glare-free lighting.

The profile is designed to be particularly slim and can be attached to the wall/ceiling or can be used as a LED pendant light with the rope suspension.

In the interior of the VA1 LED PROFILE FOR INDIRECT LIGHTING, an LED flex strip with a maximum width of 16 mm is glued in place. This profile is particularly suitable as staging effect lighting or with correspondingly powerful LED stripes as general room lighting.

Das VA1 LED PROFIL FÜR INDIREKTE BELEUCHTUNG hat eine Standardlänge von 200 cm und wird aus qualitativ hochwertigem Aluminium (eloxiert) gefertigt. Durch das rückversetzte Cover erzielt man eine indirekte und blendfreie Beleuchtung.

Das Profil ist besonders schlank konzipiert und lässt sich an der Wand/Decke anbringen oder kann mit der Seilabhängung als LED Hängeleuchte verwendet werden.

Im Innenraum des VA1 LED PROFIL FÜR INDIREKTE BELEUCHTUNG wird ein LED Strip mit einer maximalen Breite von 16 mm eingeklebt. Dieses Profil eignet sich besonders als inszenierende Effektbeleuchtung oder mit entsprechend leistungsstarken LED Flexbändern als allgemeine Raumbeleuchtung.

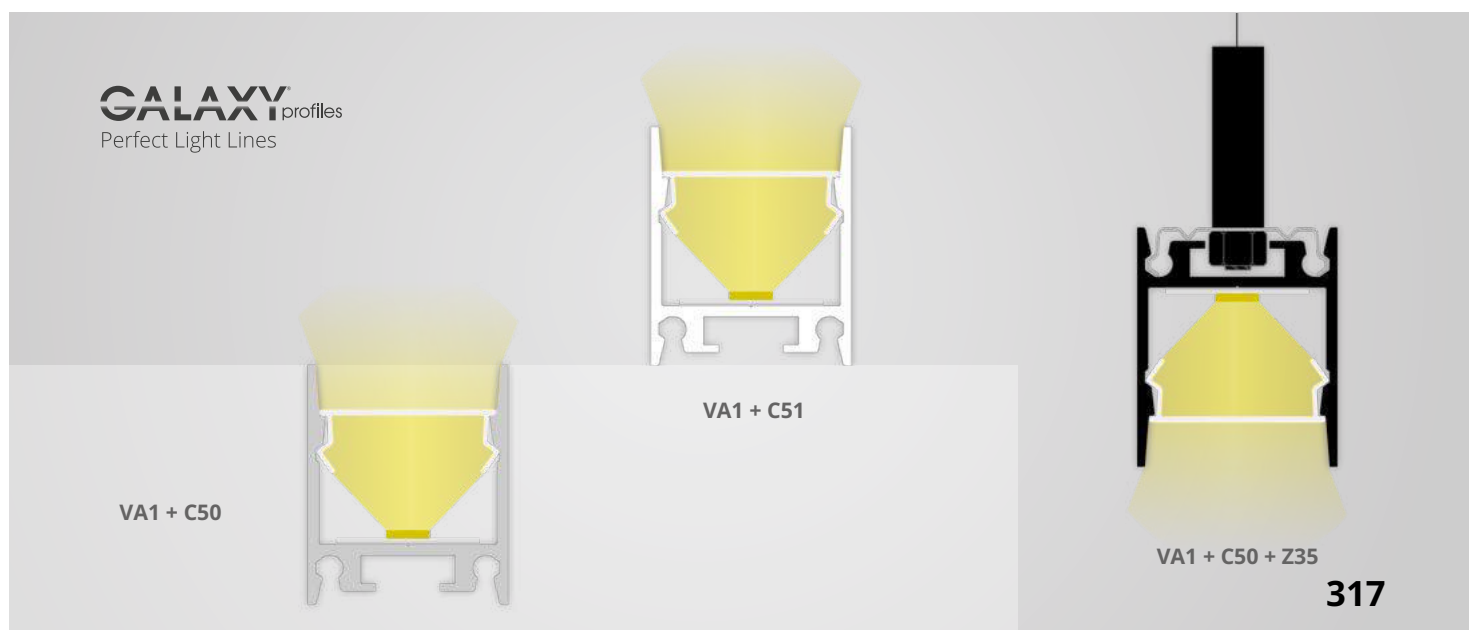

- max. 16 mm
- OEM
- Water drop icon

GALAXY profiles
Perfect Light Lines

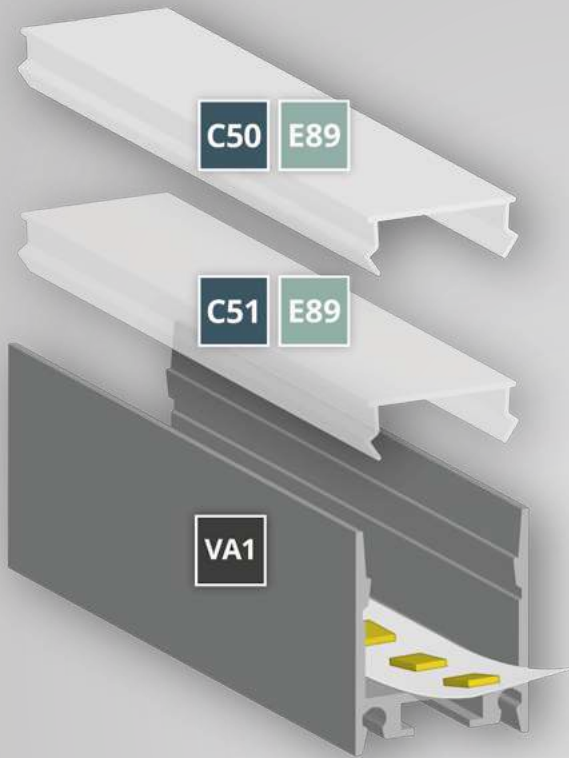

COVERS | ABDECKUNGEN

C50 65 % 200cm
8600104

C51 85 % 200cm
8600105

END CAPS | ENDKAPPEN

E89 E89 8123180 E89 8123182 E89 8123181

PROFILE

VA1 VA1 8123151 VA1W 8123153 VA1B 8123152

Z35 8123200

Z51 8123361

Z10 8301504

Z11 8301505

Z05 8301501

Z53 8123401

Z03 8301502

Z03W 8301512 Z03B 8301511

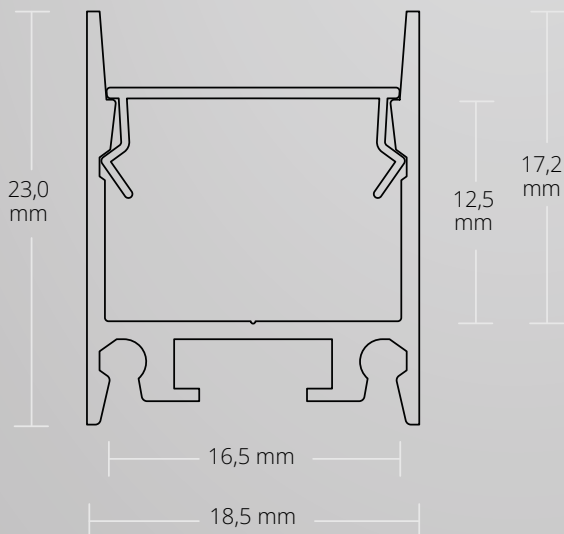

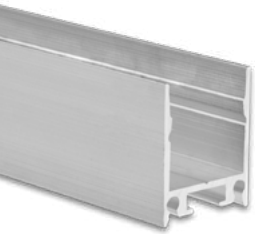

VA1 SURFACE/LUMINAIRE | AUFBAU/LEUCHTEN

LED Strips max. 16 mm
18,5 mm x 23 mm | 336 g/m

200 cm
8123151

200 cm
8123153

200 cm
8123152



Z35
Mounting Clips
Montageklammer
Sheet steel | Stahlblech
8123200



Z10 | Z11
Connector | Verbinder
Steel | Stahl | 4 PCS/STK
Z10 | 180° 8301504
Z11 | 90° 8301505



Z51
Connecting element
Verbindungselement
8123361

More P. 407 | Mehr S. 407



Z03 Hanging Wire System | Seilabhängung
Steel | Stahl | 1,5 m | Set | 75 kg
Z03 8301502 Z03W 8301512 Z03B 8301511



Z53
Connector | Verbinder
flexibel 180°- 45°
2PCS/STK | Steel | Stahl
8123401



Z05 Gripper | Gelenkgripper
Steel | Stahl | 2 PCS/STK
Z05 8301501

max.
16 mm



OEM



COVERS | ABDECKUNGEN

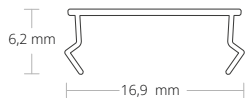

C50 opal | opal | 65 %
PC | 16,9 mm x 6,2 mm
200cm
8600104

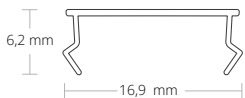
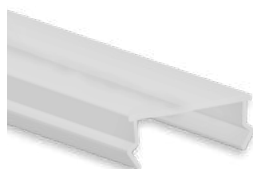

C51 clear | klar | 85 %
PC | 16,9 mm x 6,2 mm
200cm
8600105

END CAPS | ENDKAPPEN



E89 ALUMINIUM | 1 PCS/STK
E89 8123180 E89 8123182 E89 8123181

VA2

**SURFACE/LUMINAIRE |
AUFBAU/LEUCHTEN**

200 cm

max. 16 mm

 **OEM**

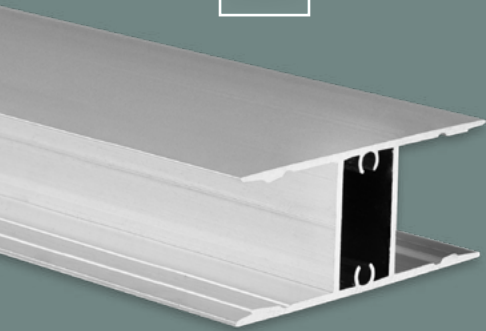

EXTENSION OF SERVICE LIFE
VERLÄNGERUNG LEBENSDAUER

MECHANICAL PROTECTION
MECHANISCHER SCHUTZ

COOLING
KÜHLUNG

HIGH LIGHT UTILISATION
HOHE LICHTVERWERTUNG

HOMOGENEOUS LIGHT
HOMOGENES LICHT

HOMOGENEOUS LIGHT with modular LED light solutions

- Wall, ceiling or floor mounting
Wand-, Decken- oder Bodenmontage
- Furniture for business equipment
Möbel für Geschäftsausstattung
- Home accessories
Wohnaccessoires
- Mirrors | Spiegel
- Shelves | Regale
- Balustrades | Balustraden
- Façades, balconies and terraces
Fassaden, Balkone und Terrassen
- Living spaces | Wohnräume
- Offices | Büroräume
- Hotel and gastronomy business
Hotellerie und Gastronomie
- Retail (shop and showcase windows)
Einzelhandel (Shop- und Schaufenster)
- Business areas and showrooms
Geschäftsflächen und Showrooms
- Barber / Beauty / body art studios
Friseur-/Beauty-/Body-Art-Studios
- Halls, foyers and corridors
Hallen, Foyers und Flure
- Wellness and indoor leisure facilities
Wellness- und Indoor-Freizeitanlagen
- Wet rooms | Nasszellen

Mounting/installation on/in wood Strips and plates, plasterboard, tiles, stone, granite, marble and metal surfaces
Montage/Einbau auf/in Holzleisten und -platten, Gipsplatten, Fliesen, Stein-, Granit-, Marmor- und Metalloberflächen

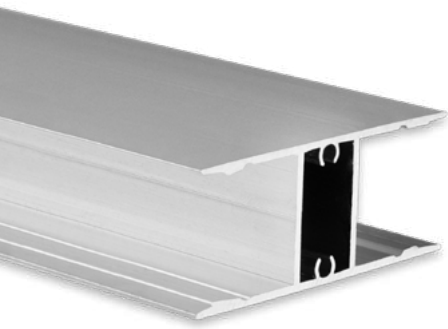

VA2

SURFACE/LUMINAIRE | AUFBAU/LEUCHTEN

LED Strips max. 16 mm

 Silver/Silber
ANODIZED | ELOXIERT

 RAL 9010 White/Weiß
POWDER-COATED | PULVERBESCHICHTET

 RAL 9005 Black/Schwarz
POWDER-COATED | PULVERBESCHICHTET

max.
16 mm



OEM



max. 16 mm

The VA2 LED PROFILE FOR INDIRECT LIGHTING has a standard length of 200cm and is made of high quality aluminium (anodized). The recessed cover achieves indirect and glare-free lighting.

The profile can be used on the one hand as a superstructure profile, with the mounting bracket Z36 specially provided for this purpose. The special feature here is that the light emission is in two directions. On the other hand, with the mounting bracket Z35 and the rope suspension Z03, the profile can be used as a LED pendant light.

In the interior of the VA2 LED PROFILE FOR INDIRECT LIGHTING, an LED flex strip with a maximum width of 16 mm is glued in place. This profile is particularly suitable as staging effect lighting or with appropriately powerful LED flex Strips as general room lighting..

Das VA2 LED PROFIL FÜR INDIREKTE BELEUCHTUNG hat eine Standardlänge von 200 cm und wird aus qualitativ hochwertigem Aluminium (eloxiert) gefertigt. Durch das rückversetzte Cover erzielt man eine indirekte und blendfreie Beleuchtung.

Das Profil kann einerseits als Aufbauprofil, mit der dafür eigens vorgesehen Montageklammer Z36 verwendet werden. Das Besondere dabei ist, dass die Lichtabstrahlung in zwei Richtungen erfolgt. Andererseits mit der Montageklammer Z35 und der Seilabhänger Z03 kann das Profil als LED Hängeleuchte eingesetzt werden.

Im Innenraum des VA2 LED PROFIL FÜR INDIREKTE BELEUCHTUNG wird ein LED Strip mit einer maximalen Breite von 16 mm eingeklebt. Dieses Profil eignet sich besonders als inszenierende Effektbeleuchtung oder mit entsprechend leistungsstarken LED Flexbändern als allgemeine Raumbelichtung.

GALAXY profiles
Perfect Light Lines

VA2 + C51 + Z36

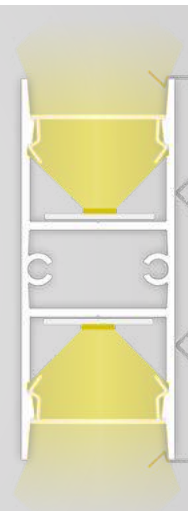
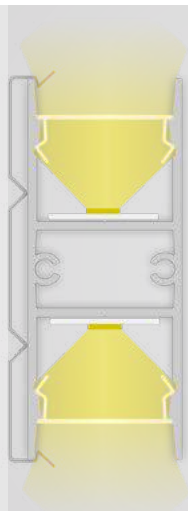

VA2 + C51 + Z36

max.
16 mm

OEM

GALAXY profiles
Perfect Light Lines

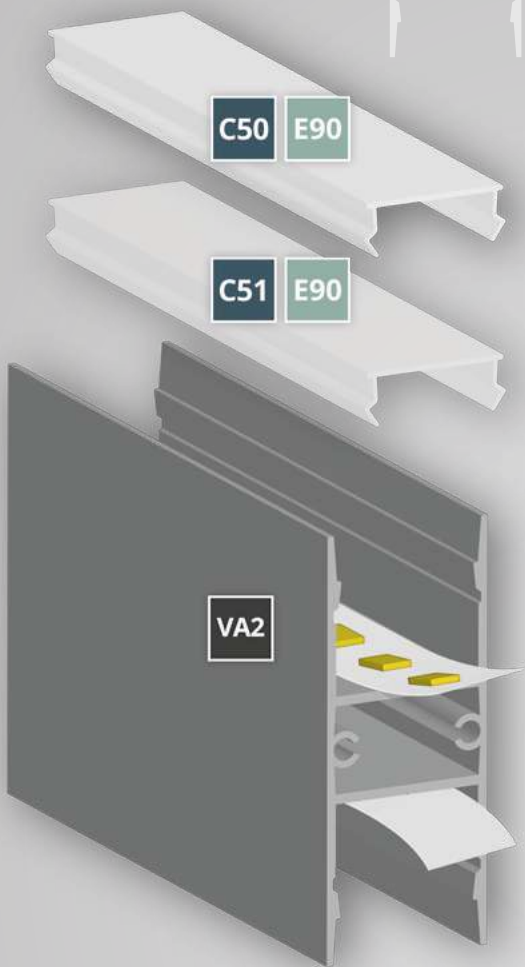
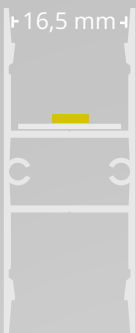

COVERS | ABDECKUNGEN

C50 65 % 200cm
8600104

C51 85 % 200cm
8600105

END CAPS | ENDKAPPEN

E90 E90 8123183 E90 8123185 E90 8123184

PROFILE

VA2 VA2 8123154 VA2W 8123156 VA2B 8123155

Z36 8123201

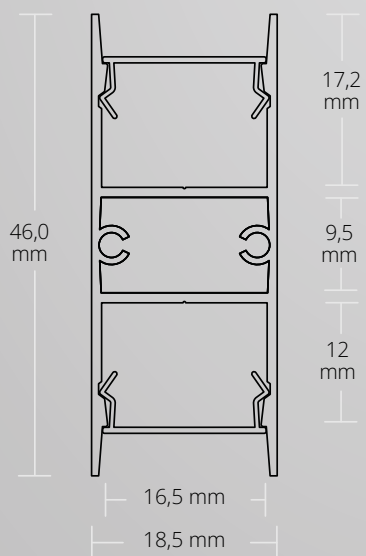



VA2 SURFACE/LUMINAIRE | AUFBAU/LEUCHTEN

LED Strips max. 16 mm
18,5 mm x 46 mm | 563 g/m

200 cm
8123154

200 cm
8123156

200 cm
8123155



Z36

Mounting Clips
Montageklammer
Sheet steel | Stahlblech
8123201



max.
16 mm



OEM



COVERS | ABDECKUNGEN

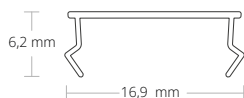

C50 opal | opal | 65 %
PC | 16,9 mm x 6,2 mm
200cm
8600104

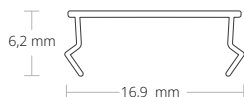
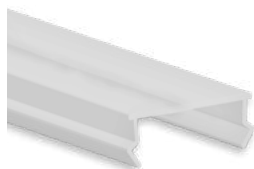

C51 clear | klar | 85 %
PC | 16,9 mm x 6,2 mm
200cm
8600105

END CAPS | ENDKAPPEN



E90 ALUMINIUM | 1 PCS/STK

E90
8123183

E90
8123185

E90
8123184

VA3

**SURFACE/LUMINAIRE |
AUFBAU/LEUCHTEN**

200 cm

max. 16 mm

 **OEM**

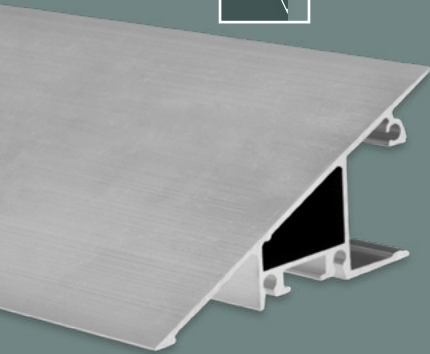

EXTENSION OF SERVICE LIFE
VERLÄNGERUNG LEBENSDAUER

MECHANICAL PROTECTION
MECHANISCHER SCHUTZ

COOLING
KÜHLUNG

HIGH LIGHT UTILISATION
HOHE LICHTVERWERTUNG

HOMOGENEOUS LIGHT
HOMOGENES LICHT

HOMOGENEOUS LIGHT with modular LED light solutions

- Wall, ceiling or floor mounting
Wand-, Deckenmontage
- Furniture for business equipment
Möbel für Geschäftsausstattung
- Home accessories
Wohnaccessoires
- Display cases | Vitrinen
- Shelves | Regale
- Balustrades | Balustraden
- Façades, balconies and terraces
Fassaden, Balkone und Terrassen
- Living spaces | Wohnräume
- Offices | Büroräume
- Hotel and gastronomy business
Hotellerie und Gastronomie
- Retail (shop and showcase windows)
Einzelhandel (Shop- und Schaufenster)
- Business areas and showrooms
Geschäftsflächen und Showrooms
- Barber / Beauty / body art studios
Friseur-/Beauty-/Body-Art-Studios
- Halls, foyers and corridors
Hallen, Foyers und Flure
- Wellness and indoor leisure facilities
Wellness- und Indoor-Freizeitanlagen
- Wet rooms | Nasszellen

Mounting/installation on/in wood Strips and plates, plasterboard, tiles, stone, granite, marble and metal surfaces
Montage/Einbau auf/in Holzleisten und -platten, Gipsplatten, Fliesen, Stein-, Granit-, Marmor- und Metalloberflächen

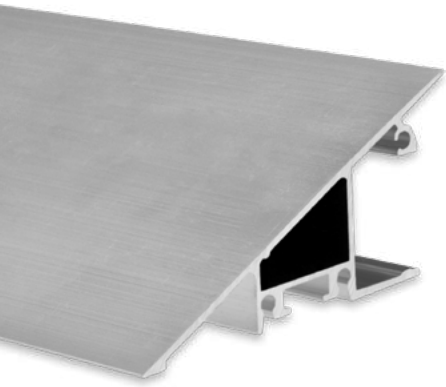

VA3

SURFACE/LUMINAIRE | AUFBAU/LEUCHTEN

LED Strips max. 16 mm

 Silver/Silber
ANODIZED | ELOXIERT

 RAL 9010 White/Weiß
POWDER-COATED | PULVERBESCHICHTET

 RAL 9005 Black/Schwarz
POWDER-COATED | PULVERBESCHICHTET



max. 16 mm

max.
16 mm



OEM



The VA3 LED PROFILE FOR INDIRECT LIGHTING has a standard length of 200cm and is made of high quality aluminum (anodized). The recessed cover allows you to achieve indirect and glare-free lighting.

The profile in the triangle design is available in silver (anodized aluminum), white and black. It perfectly fits for a decorative use.

In the interior of the VA3 LED PROFILE FOR INDIRECT LIGHTING, an LED flex tape with a maximum width of 16 mm is glued in. This profile is particularly suitable as staging effect lighting or with appropriately powerful LED flex Strips as general room lighting.

Das VA3 LED PROFIL FÜR INDIREKTE BELEUCHTUNG hat eine Standardlänge von 200 cm und wird aus qualitativ hochwertigem Aluminium (eloxiert) gefertigt. Durch das rückversetzte Cover erzielt man eine indirekte und blendfreie Beleuchtung.

Das Profil im Dreiecks Design ist in den Farben silber (Aluminium eloxiert), weiß und schwarz verfügbar und eignet sich hervorragend für einen dekorativen Einsatz.

Im Innenraum des VA3 LED PROFIL FÜR INDIREKTE BELEUCHTUNG wird ein LED Strip mit einer maximalen Breite von 16 mm eingeklebt. Dieses Profil eignet sich besonders als inszenierende Effektbeleuchtung oder mit entsprechend leistungsstarken LED Flexbändern als allgemeine Raumbelichtung.

GALAXY profiles
Perfect Light Lines

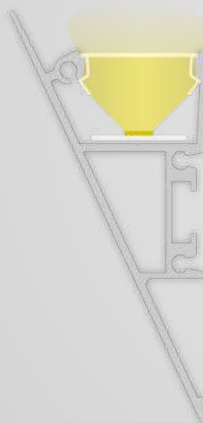

VA3 + C50



VA3 + C50

325

max.
16 mm

OEM



GALAXY profiles
Perfect Light Lines

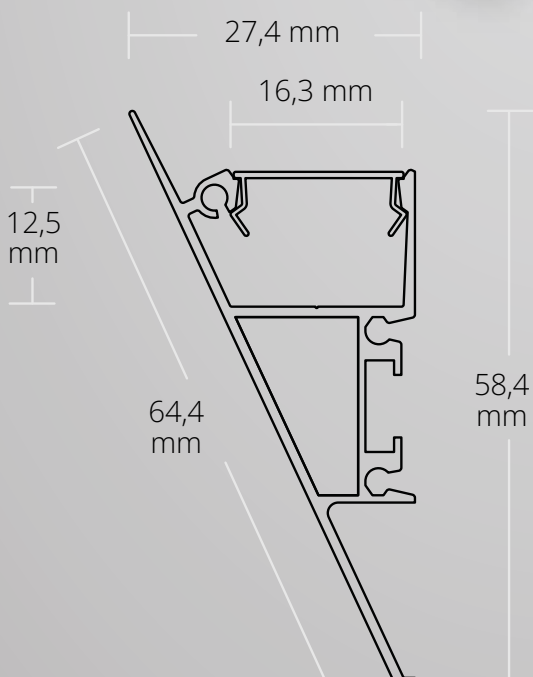
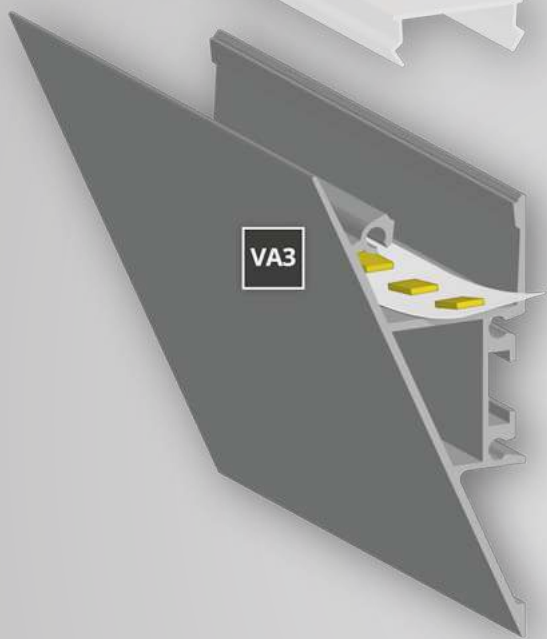

COVERS | ABDECKUNGEN

C50 65 % 200cm
8600104

C51 85 % 200cm
8600105

END CAPS | ENDKAPPEN

E91  E91 8123186  E91 8123188  E91 8123187

PROFILE

VA3  VA3 8123157  VA3W 8123159  VA3B 8123158

  Z35 8123200

  Z51 8123361

  Z10 8301504

  Z11 8301505

  Z53 8123401

VA3 SURFACE/LUMINAIRE | AUFBAU/LEUCHTEN

LED Strips max. 16 mm
27,4 mm x 58,4 mm | 622 g/m

200 cm
8123157

200 cm
8123159

200 cm
8123158



Z35
Mounting Clips
Montageklammer
Sheet steel | Stahlblech
8123200



Z10 | Z11
Connector | Verbinder
Steel | Stahl | 4 PCS/STK
Z10 | 180° 8301504
Z11 | 90° 8301505



Z51
Connecting element
Verbindungselement
8123361



Z53
Connector | Verbinder
flexibel 180°- 45°
2PCS/STK | Steel | Stahl
8123401

max.
16 mm

OEM



More P. 407 | Mehr S. 407

COVERS | ABDECKUNGEN

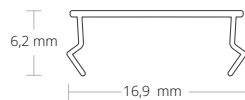

C50 opal | opal | 65 %
PC | 16,9 mm x 6,2 mm
200cm
8600104

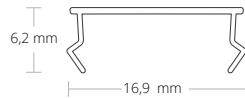
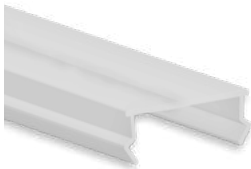

C51 clear | klar | 85 %
PC | 16,9 mm x 6,2 mm
200cm
8600105

END CAPS | ENDKAPPEN



E91 ALUMINIUM | 1 PCS/STK

E91
8123186

E91
8123188

E91
8123187

VA4

**SURFACE/LUMINAIRE |
AUFBAU/LEUCHTEN**

200 cm

max. 16 mm / 14 mm

OEM

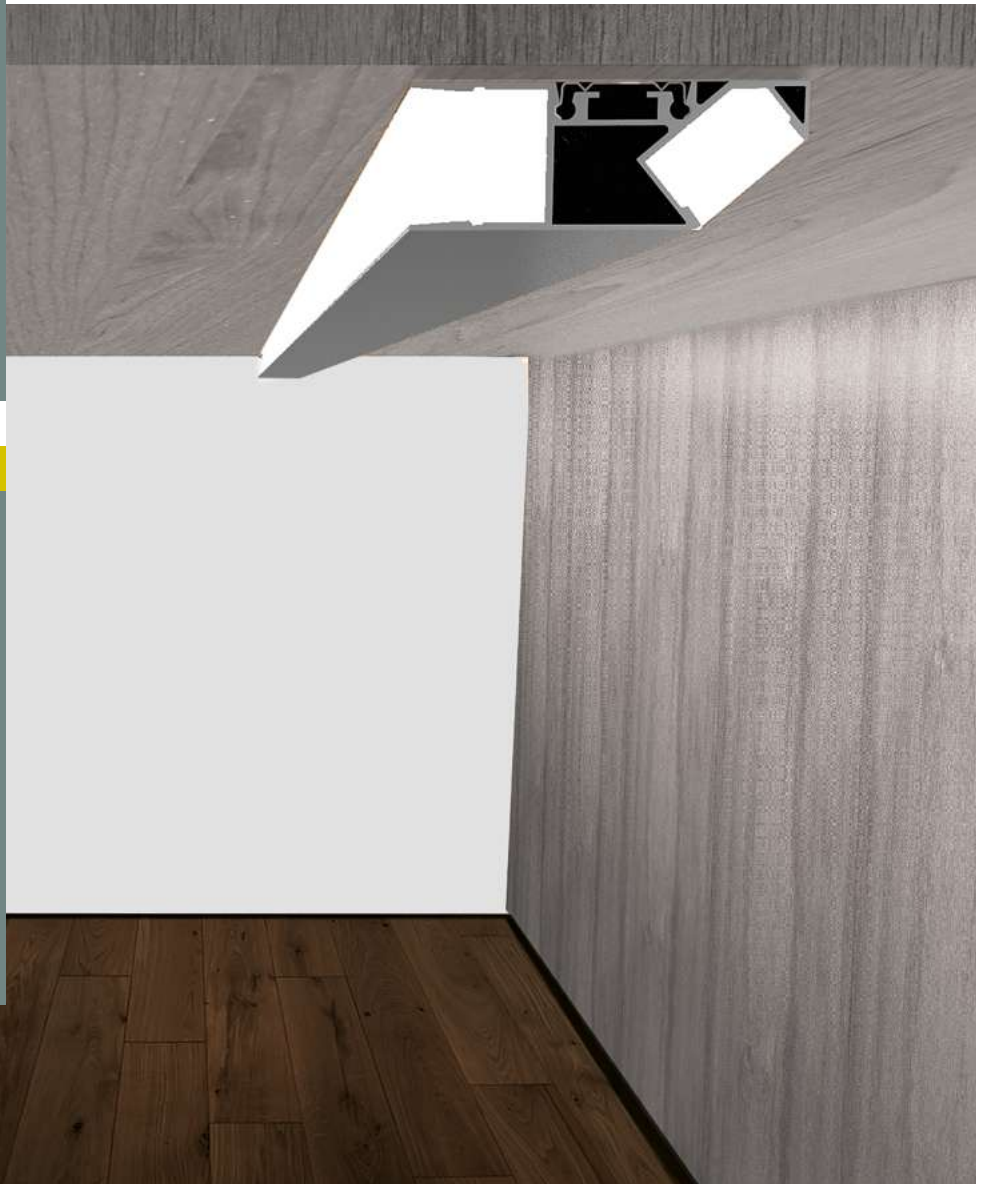
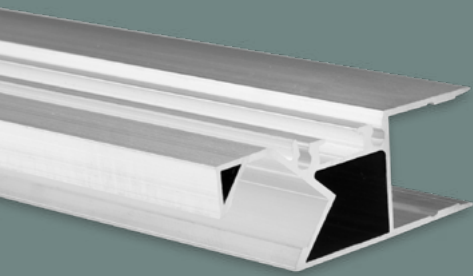

EXTENSION OF SERVICE LIFE
VERLÄNGERUNG LEBENSDAUER

MECHANICAL PROTECTION
MECHANISCHER SCHUTZ

COOLING
KÜHLUNG

HIGH LIGHT UTILISATION
HOHE LICHTVERWERTUNG

HOMOGENEOUS LIGHT
HOMOGENES LICHT

HOMOGENEOUS LIGHT with modular LED light solutions

- Wall, ceiling or floor mounting
Wand-, Deckenmontage
- Furniture for business equipment
Möbel für Geschäftsausstattung
- Home accessories
Wohnaccessoires
- Display cases | Vitrinen
- Shelves | Regale
- Balustrades | Balustraden
- Façades, balconies and terraces
Fassaden, Balkone und Terrassen
- Living spaces | Wohnräume
- Offices | Büroräume
- Hotel and gastronomy business
Hotellerie und Gastronomie
- Retail (shop and showcase windows)
Einzelhandel (Shop- und Schaufenster)
- Business areas and showrooms
Geschäftsflächen und Showrooms
- Barber / Beauty / body art studios
Friseur-/Beauty-/Body-Art-Studios
- Halls, foyers and corridors
Hallen, Foyers und Flure
- Wellness and indoor leisure facilities
Wellness- und Indoor-Freizeitanlagen
- Wet rooms | Nasszellen

Mounting/installation on/in wood Strips and plates, plasterboard, tiles, stone, granite, marble and metal surfaces
Montage/Einbau auf/in Holzleisten und -platten, Gipsplatten, Fliesen, Stein-, Granit-, Marmor- und Metalloberflächen



VA4

SURFACE/LUMINAIRE | AUFBAU/LEUCHTEN

LED Strips max. 16 mm / 14 mm

 Silver/Silber
ANODIZED | ELOXIERT

 RAL 9010 White/Weiß
POWDER-COATED | PULVERBESCHICHTET

 RAL 9005 Black/Schwarz
POWDER-COATED | PULVERBESCHICHTET



max. 16 mm

max. 14 mm

max.
16 mm /
14 mm



OEM



The VA4 LED PROFILE FOR INDIRECT LIGHTING has a standard length of 200cm and is made of high quality aluminium (anodized). The recessed cover allows you to achieve indirect and glare-free lighting.

The profile impresses with its extraordinary design, this allows a double-sided light emission. Here, one side radiates straight below and the other 50 degrees upwards.

In the interior of the VA4 LED PROFILE FOR INDIRECT LIGHTING, an LED flex tape with a maximum width of 14 or 16 mm is glued in place. This profile is particularly suitable as staging effect lighting or with correspondingly powerful LED flex Strips as general room lighting.

Das VA4 LED PROFIL FÜR INDIREKTE BELEUCHTUNG hat eine Standardlänge von 200 cm und wird aus qualitativ hochwertigem Aluminium (eloxiert) gefertigt. Durch das rückversetzte Cover erzielt man eine indirekte und blendfreie Beleuchtung.

Das Profil besticht durch sein außergewöhnliches Design, dies ermöglicht eine beidseitige Lichtabstrahlung. Dabei strahlt eine Seite gerade nach unten und die andere 50 Grad nach oben.

Im Innenraum des VA4 LED PROFIL FÜR INDIREKTE BELEUCHTUNG wird ein LED Strip mit einer maximalen Breite von 14 oder 16 mm eingeklebt. Dieses Profil eignet sich besonders als inszenierende Effektbeleuchtung oder mit entsprechend leistungsstarken LED Flexbändern als allgemeine Raumbeleuchtung.

GALAXY profiles
Perfect Light Lines

VA4 + C50

VA4 + C50

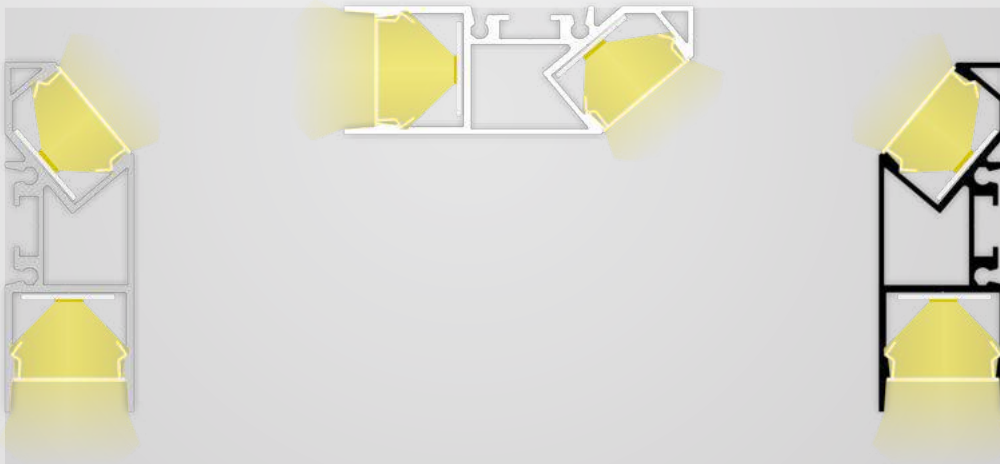

VA4 + C50

329

max.
16 mm /
14 mm

GALAXY profiles
Perfect Light Lines



OEM

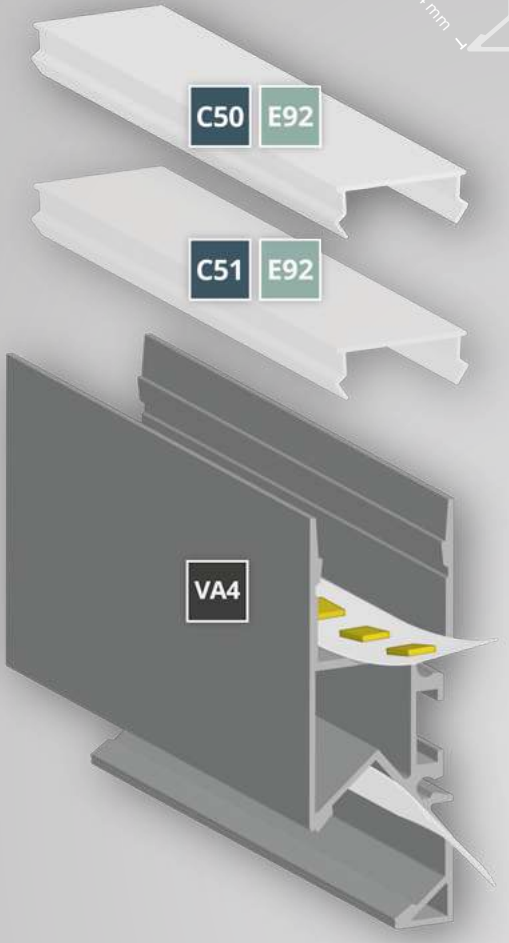

COVERS | ABDECKUNGEN

C50 65 % 200cm
8600104

C51 85 % 200cm
8600105

END CAPS | ENDKAPPEN

E92 E92 8123189 E92 8123191 E92 8123190

PROFILE

VA4 VA4 8123160 VA4W 8123162 VA4B 8123161

Z35 8123200

Z51 8123361

Z10 8301504

Z11 8301505

Z53 8123401

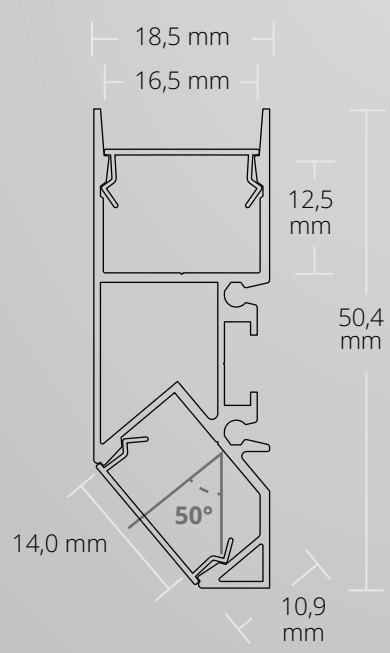



VA4 SURFACE/LUMINAIRE | AUFBAU/LEUCHTEN

LED Strips max. 16 mm / 14 mm

18,5 mm x 50,4 mm | 615 g/m

200 cm
8123160

200 cm
8123162

200 cm
8123161



Z35
Mounting Clips
Montageklammer
Sheet steel | Stahlblech
8123200



Z10 | Z11
Connector | Verbinder
Steel | Stahl | 4 PCS/STK
Z10 | 180° 8301504
Z11 | 90° 8301505



Z51
Connecting element
Verbindungselement
8123361

More P. 407 | Mehr S. 407



Z53
Connector | Verbinder
flexibel 180°- 45°
2PCS/STK | Steel | Stahl
8123401



max.
16 mm /
14 mm



OEM



COVERS | ABDECKUNGEN

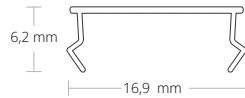

C50 opal | opal | 65 %
PC | 16,9 mm x 6,2 mm
200cm
8600104

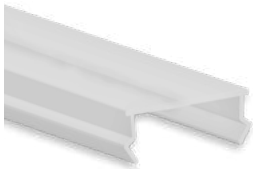

C51 clear | klar | 85 %
PC | 16,9 mm x 6,2 mm
200cm
8600105

END CAPS | ENDKAPPEN



E92 ALUMINIUM | 1 PCS/STK
E92 8123189 E92 8123191 E92 8123190

VA5

**SURFACE/LUMINAIRE |
AUFBAU/LEUCHTEN**

200 cm

max. 16 mm

OEM

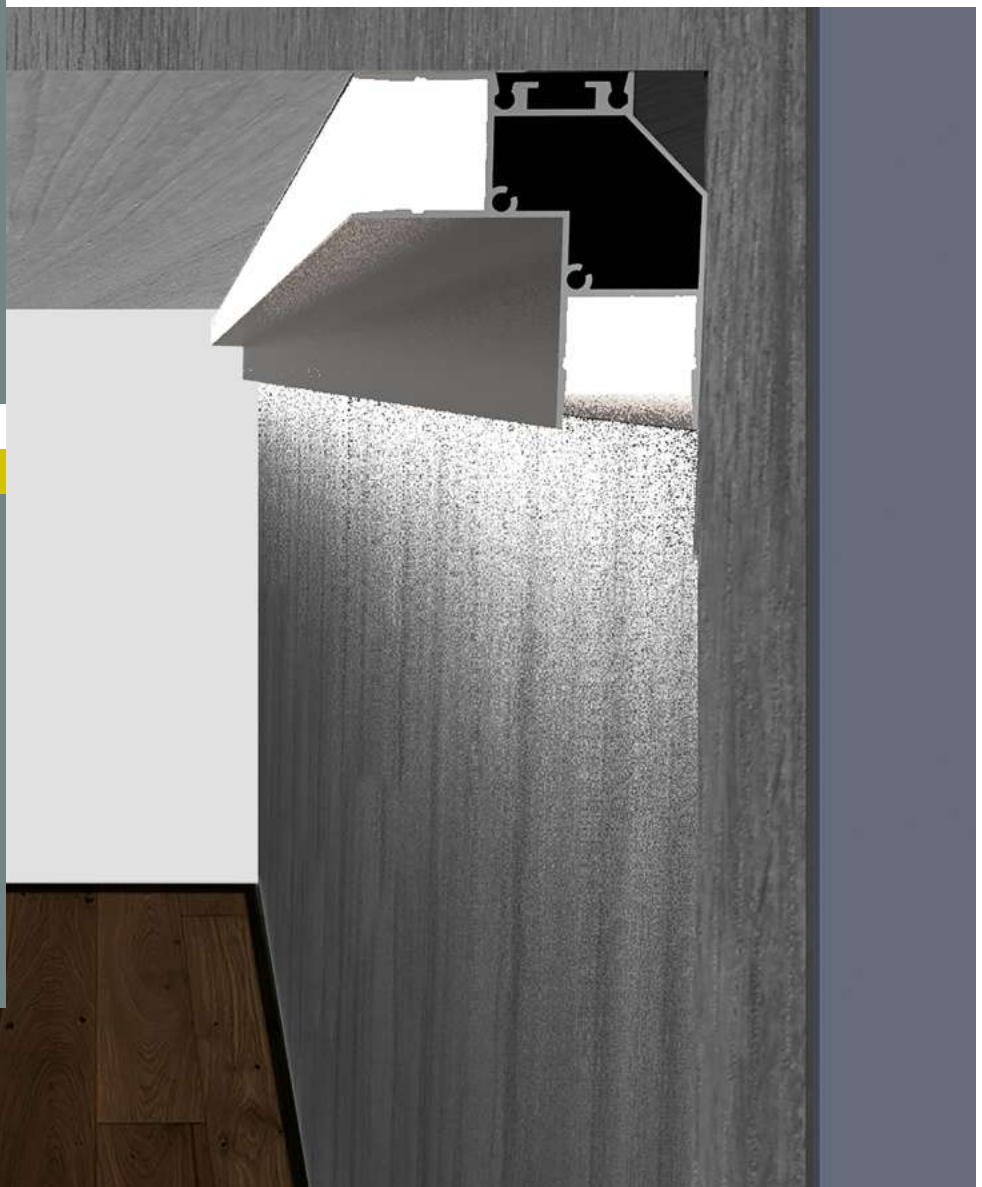
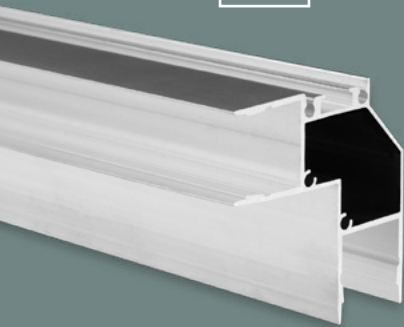

EXTENSION OF SERVICE LIFE
VERLÄNGERUNG LEBENSDAUER

MECHANICAL PROTECTION
MECHANISCHER SCHUTZ

COOLING
KÜHLUNG

HIGH LIGHT UTILISATION
HOHE LICHTVERWERTUNG

HOMOGENEOUS LIGHT
HOMOGENES LICHT

HOMOGENEOUS LIGHT with modular LED light solutions

- Wall, ceiling mounting
Wand-, Deckenmontage
- Residential and office furniture
Wohn- und Büromöbel
- Home accessories
Wohnaccessoires
- Shelves | Regale
- Balustrades | Balustraden
- Façades, balconies and terraces
Fassaden, Balkone und Terrassen
- Living spaces | Wohnräume
- Offices | Büroräume
- Hotel and gastronomy business
Hotellerie und Gastronomie
- Retail (shop and showcase windows)
Einzelhandel (Shop- und Schaufenster)
- Business areas and showrooms
Geschäftsflächen und Showrooms
- Barber / Beauty / body art studios
Friseur-/Beauty-/Body-Art-Studios
- Halls, foyers and corridors
Hallen, Foyers und Flure
- Wellness and indoor leisure facilities
Wellness- und Indoor-Freizeitanlagen
- Wet rooms | Nasszellen

Mounting/installation on/in wood Strips and plates, plasterboard, tiles, stone, granite, marble and metal surfaces
Montage/Einbau auf/in Holzleisten und -platten, Gipsplatten, Fliesen, Stein-, Granit-, Marmor- und Metalloberflächen



VA5

SURFACE/LUMINAIRE | AUFBAU/LEUCHTEN

LED Strips max. 16 mm

 Silver/Silber
ANODIZED | ELOXIERT

 RAL 9010 White/Weiß
POWDER-COATED | PULVERBESCHICHTET

 RAL 9005 Black/Schwarz
POWDER-COATED | PULVERBESCHICHTET

max.
16 mm



OEM



max. 16 mm

The VA5 LED PROFILE FOR INDIRECT LIGHTING has a standard length of 200 cm and is made of high quality aluminum (anodized). The recessed cover achieves indirect and glare-free lighting.

The profile is suitable for corner mounting and then there is a double-sided light emission.

In the interior of the VA5 LED PROFILE FOR INDIRECT LIGHTING, an LED flex strip with a maximum width of 16 mm is glued in place. This profile is particularly suitable as staging effect lighting or with appropriately powerful LED flex Strips as general room lighting.

Das VA5 LED PROFIL FÜR INDIREKTE BELEUCHTUNG hat eine Standardlänge von 200 cm und wird aus qualitativ hochwertigem Aluminium (eloxiert) gefertigt. Durch das rückversetzte Cover erzielt man eine indirekte und blendfreie Beleuchtung.

Das Profil ist für eine Eckmontage geeignet und es erfolgt dann eine beidseitige Lichtabstrahlung.

Im Innenraum des VA5 LED PROFIL FÜR INDIREKTE BELEUCHTUNG wird ein LED Strip mit einer maximalen Breite von 16 mm eingeklebt. Dieses Profil eignet sich besonders als inszenierende Effektbeleuchtung oder mit entsprechend leistungsstarken LED Flexbändern als allgemeine Raumbelichtung.

GALAXY profiles
Perfect Light Lines

VA5 + C50



VA5 + C50

VA5 + C50



333

max.
16 mm

OEM



GALAXY profiles
Perfect Light Lines

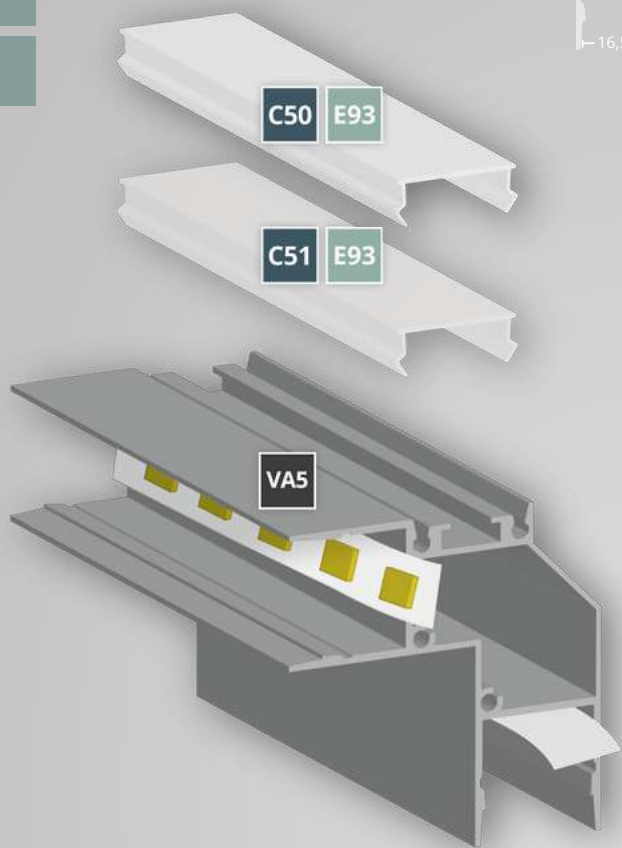
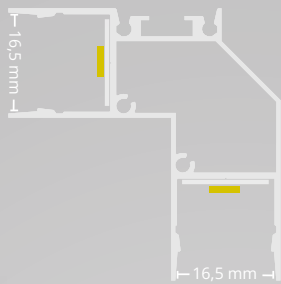

COVERS | ABDECKUNGEN

C50 65 % 200cm
8600104

C51 85 % 200cm
8600105

END CAPS | ENDKAPPEN

E93  E93 8123192  E93 8123194  E93 8123193

PROFILE

VA5  VA5 8123163  VA5W 8123165  VA5B 8123164

 **Z35** 8123200

 **Z51** 8123361

 **Z10** 8301504

 **Z11** 8301505

 **Z53** 8123401

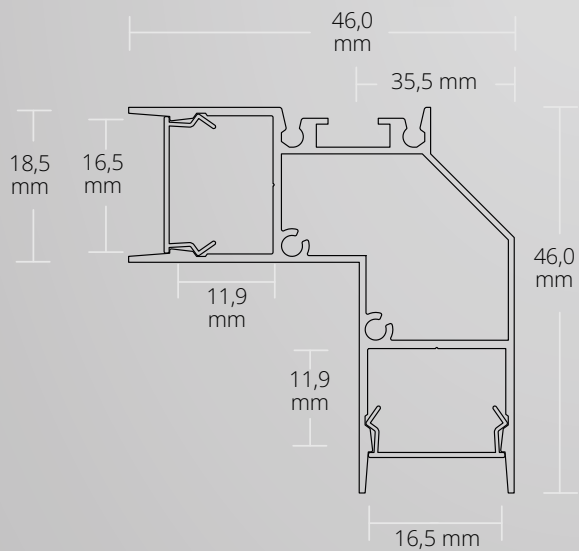

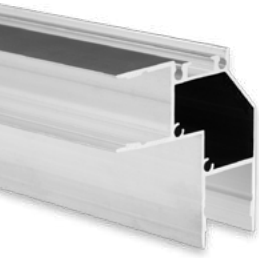

VA5 SURFACE/LUMINAIRE | AUFBAU/LEUCHTEN

LED Strips max. 16 mm
46 mm x 46 mm | 763 g/m

200 cm
8123163

200 cm
8123165

200 cm
8123164



Z35
Mounting Clips
Montageklammer
Sheet steel | Stahlblech
8123200



Z10 | Z11
Connector | Verbinder
Steel | Stahl | 4 PCS/STK
Z10 | 180° 8301504
Z11 | 90° 8301505



Z51
Connecting element
Verbindungselement
8123361



Z53
Connector | Verbinder
flexibel 180°- 45°
2PCS/STK | Steel | Stahl
8123401

max.
16 mm



OEM



More P. 407 | Mehr S. 407

COVERS | ABDECKUNGEN



C50 opal | opal | 65 %
PC | 16,9 mm x 6,2 mm
200cm
8600104

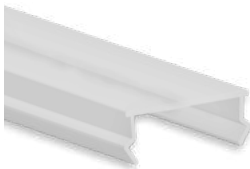

C51 clear | klar | 85 %
PC | 16,9 mm x 6,2 mm
200cm
8600105

END CAPS | ENDKAPPEN



E93 ALUMINIUM | 1 PCS/STK
E93 8123192 E93 8123194 E93 8123193

VA6

**SURFACE/LUMINAIRE |
AUFBAU/LEUCHTEN**

200 cm

max. 12/14 mm

OEM

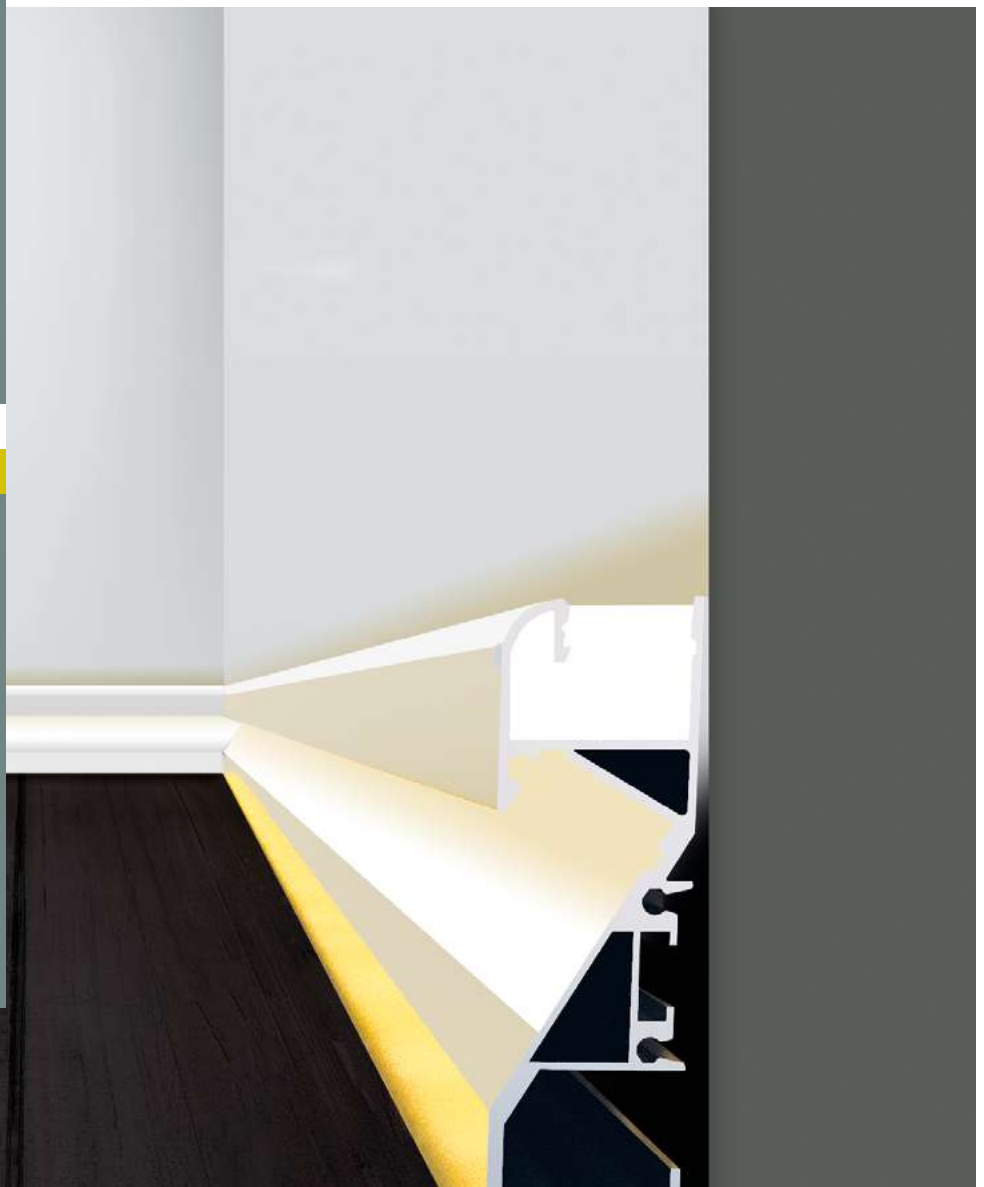

EXTENSION OF SERVICE LIFE
VERLÄNGERUNG LEBENSDAUER

MECHANICAL PROTECTION
MECHANISCHER SCHUTZ

COOLING
KÜHLUNG

HIGH LIGHT UTILISATION
HOHE LICHTVERWERTUNG

HOMOGENEOUS LIGHT
HOMOGENES LICHT

HOMOGENEOUS LIGHT with modular LED light solutions

- Wall mounting
Wand-, Decken- oder Bodenmontage
- Balustrades | Balustraden
- Façades, balconies and terraces
Fassaden, Balkone und Terrassen
- Living spaces | Wohnräume
- Offices | Büroräume
- Hotel and gastronomy business
Hotellerie und Gastronomie
- Retail (shop and showcase windows)
Einzelhandel (Shop- und Schaufenster)
- Business areas and showrooms
Geschäftsflächen und Showrooms
- Barber / Beauty / body art studios
Friseur-/Beauty-/Body-Art-Studios
- Halls, foyers and corridors
Hallen, Foyers und Flure
- Wellness and indoor leisure facilities
Wellness- und Indoor-Freizeitanlagen

Mounting/installation on/in wood Strips and plates, plasterboard, tiles, stone, granite, marble and metal surfaces
Montage/Einbau auf/in Holzleisten und -platten, Gipsplatten, Fliesen, Stein-, Granit-, Marmor- und Metalloberflächen



VA6

SURFACE/LUMINAIRE | AUFBAU/LEUCHTEN SKIRTING BOARD | SOCKELLEISTE

LED Strips max. 12/14 mm

□ RAL 9010 White/Weiß
POWDER-COATED | PULVERBESCHICHTET

■ RAL 9005 Black/Schwarz
POWDER-COATED | PULVERBESCHICHTET



max. 12/14 mm

max.
12/14 mm



OEM



The VA6 LED PROFILE FOR INDIRECT LIGHTING has a standard length of 200cm and is made of high quality aluminum (anodized). The recessed cover allows you to achieve indirect and glare-free lighting.

The profile is available in the colors white and black and was specially developed as a skirting profile. Here, one side radiates upwards to the wall and with the second side the floor is illuminated.

In the interior of the VA6 LED PROFILE FOR INDIRECT LIGHTING is glued LED flex tape with a maximum width of 12 or 14 mm. This profile is particularly suitable as a staging effect lighting.

Das VA6 LED PROFIL FÜR INDIREKTE BELEUCHTUNG hat eine Standardlänge von 200 cm und wird aus qualitativ hochwertigem Aluminium (eloxiert) gefertigt. Durch das rückversetzte Cover erzielt man eine indirekte und blendfreie Beleuchtung.

Das Profil ist in den Farben weiß und schwarz verfügbar und wurde speziell als Sockelleistenprofil entwickelt. Dabei strahlt eine Seite nach oben an die Wand und mit der zweiten Seite wird der Boden beleuchtet.

Im Innenraum des VA6 LED PROFIL FÜR INDIREKTE BELEUCHTUNG wird ein LED Strip mit einer maximalen Breite von 12 oder 14 mm eingeklebt. Dieses Profil eignet sich besonders als inszenierende Effektbeleuchtung.

GALAXY profiles
Perfect Light Lines

VA6 + C27



VA6 + C27



max.
12/14mm

OEM

GALAXY profiles
Perfect Light Lines

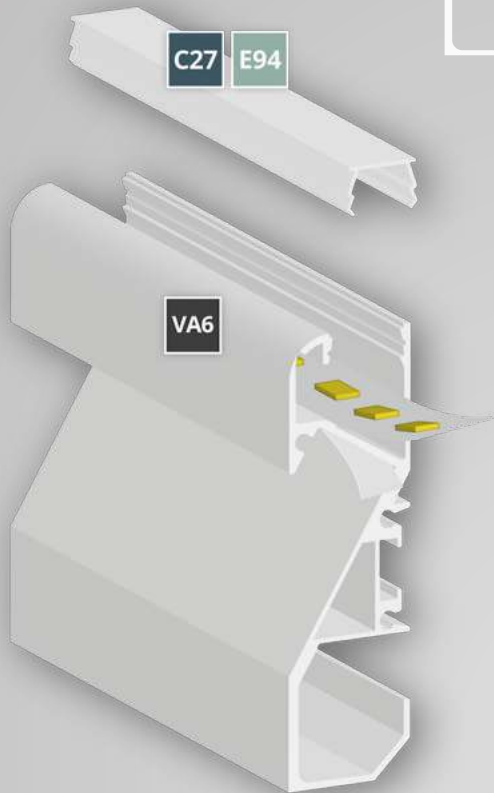

COVERS | ABDECKUNGEN

C27 65 % 200cm 300cm
8600084 8600113

END CAPS | ENDKAPPEN

E94 E94 E94
8123196 8123195

PROFILE

VA6 VA6W VA6B
8123166 8123167

Z35
8123200

Z51
8123361

Z10
8301504

Z11
8301505

Z53
8123401

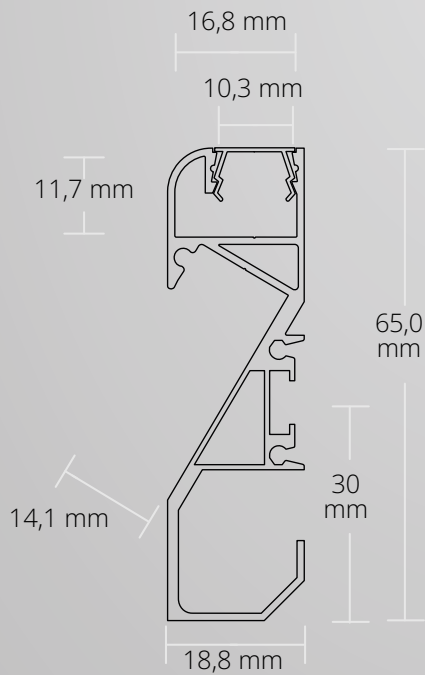



VA6 SURFACE/LUMINAIRE | AUFBAU/LEUCHTEN

LED Strips max. 12/16 mm
18,8 mm x 65 mm | 971 g/m

200 cm
8123166

200 cm
8123167



Z35
Mounting Clips
Montageklammer
Sheet steel | Stahlblech
8123200



Z10 | Z11
Connector | Verbinder
Steel | Stahl | 4 PCS/STK
Z10 | 180° 8301504
Z11 | 90° 8301505



Z51
Connecting element
Verbindungselement
8123361

More P. 407 | Mehr S. 407



Z53
Connector | Verbinder
flexibel 180°- 45°
2PCS/STK | Steel | Stahl
8123401

COVERS | ABDECKUNGEN

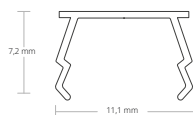

C27 opal | opal | 65 %
PC | 11,1 mm x 7,2 mm
200cm 300cm
8600084 8600113

END CAPS | ENDKAPPEN



E94 ALUMINIUM | 1 PCS/STK

E94
8123196

E94
8123195

max.
12/14 mm



OEM



MP1

RECESSED | EINBAU

200 cm

max. 6 mm

OEM

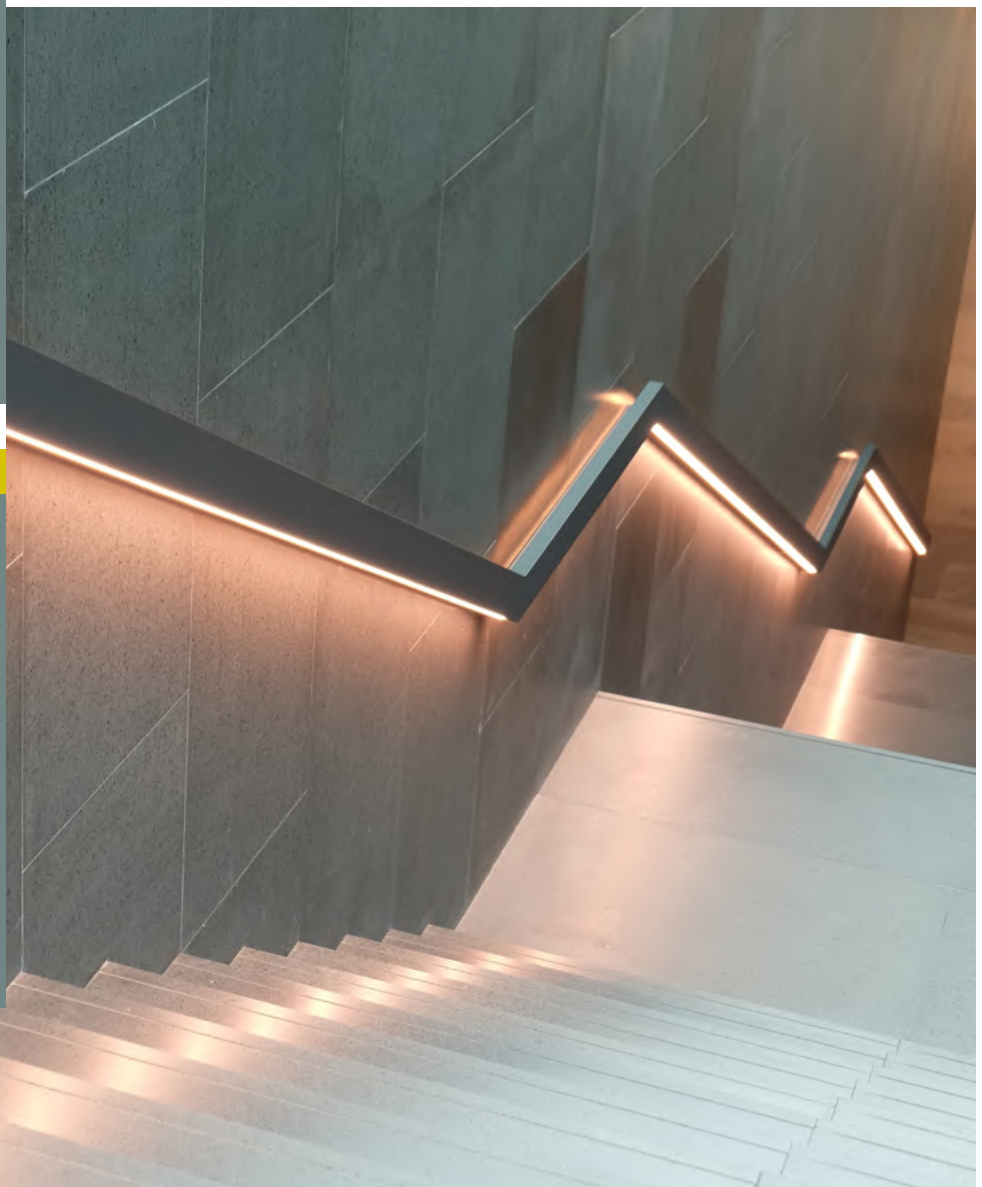
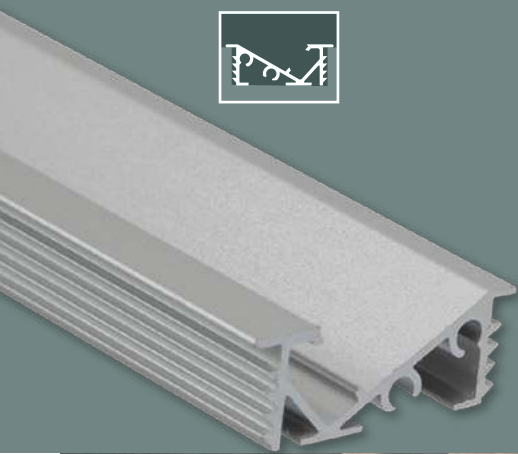

EXTENSION OF SERVICE LIFE
VERLÄNGERUNG LEBENSDAUER

MECHANICAL PROTECTION
MECHANISCHER SCHUTZ

COOLING
KÜHLUNG

HIGH LIGHT UTILISATION
HOHE LICHTVERWERTUNG

HOMOGENEOUS LIGHT
HOMOGENES LICHT

HOMOGENEOUS LIGHT with modular LED light solutions

- Wall, ceiling or floor mounting
Wand-, Decken- oder Bodenmontage
- Residential and office furniture
Wohn- und Büromöbel
- Furniture for business equipment
Möbel für Geschäftsausstattung
- Home accessories
Wohnaccessoires
- Stairs and railings
Treppenstufen und -Geländer
- Balustrades | Balustraden
- Façades, balconies and terraces
Fassaden, Balkone und Terrassen
- Living spaces | Wohnräume
- Offices | Büroräume
- Hotel and gastronomy business
Hotellerie und Gastronomie
- Retail (shop and showcase windows)
Einzelhandel (Shop- und Schaufenster)
- Business areas and showrooms
Geschäftsflächen und Showrooms
- Barber / Beauty / body art studios
Friseur-/Beauty-/Body-Art-Studios
- Halls, foyers and corridors
Hallen, Foyers und Flure
- Wellness and indoor leisure facilities
Wellness- und Indoor-Freizeitanlagen
- Wet rooms | Nasszellen

Mounting/installation on/in wood Strips and plates, plasterboard, tiles, stone, granite, marble and metal surfaces
Montage/Einbau auf/in Holzleisten und -platten, Gipsplatten, Fliesen, Stein-, Granit-, Marmor- und Metalloberflächen



MP1

RECESSED | EINBAU

Möbelprofil | Furniture profile | LED Strips max. 6 mm

 Silver/Silber
ANODIZED | ELOXIERT

 RAL 9010 White/Weiß
POWDER-COATED | PULVERBESCHICHTET

 RAL 9005 Black/Schwarz
POWDER-COATED | PULVERBESCHICHTET



max. 6 mm

max.
6 mm



OEM

The MP1 LED RECESSED profile has a particularly narrow and flat design, is designed for LED flex Strips with a maximum width of 6 mm and is used universally indoors. This aluminium profile can also be used for application-specific installation.

The profile is also available in the colours white and black.

The LED profile cover opal/satinised (translucency 65 % - also available 600 cm) is made of shatter-proof and non-flammable polycarbonate (classification flammability UL94 V-2) and create homogeneous LED lighting conditions with high utilisation of the light output.

This LED profiles are ideally suited as a LED light source in residential and office furniture, home accessories, display cases, shelves and stairs and of course on walls and ceilings, among other things, due to their small dimensions and low weight.

* Classification flammability UL94 V-2: Extinguishing of a vertically clamped sample within 30 seconds.

Das MP1 LED EINBAU-Profil hat ein besonders schmales und flaches Design, ist für LED Flexbänder mit einer maximalen Breite von 6 mm konzipiert und wird universell im Innenbereich eingesetzt. Dieses Alu-Profil kann auch eingebaut werden.

Das Profil ist auch in die Farben weiß und schwarz verfügbar.

Die LED Profilabdeckung Opal/satiniert (Lichtdurchlässigkeit 65 % - auch 600 cm erhältlich) besteht aus bruchsicherem und schwer brennbarem Polycarbonat (Klassifizierung Brennbarkeit UL94 V-2) und schaffen homogene LED Lichtverhältnisse mit hoher Verwertung der Lichtleistung.

Aufgrund der kleinen Abmessungen und des geringen Gewichtes sind diese LED Profile unter anderem als ideale LED Lichtquelle in Wohn- und Büromöbeln, Wohnaccessoires, Vitrinen, Regalen sowie an Treppenstufen und selbstverständlich an Wänden und Decken geeignet.

*Klassifizierung Brennbarkeit UL94 V-2: Verlöschen einer vertikal eingespannten Probe innerhalb von 30 Sekunden.

GALAXY profiles
Perfect Light Lines

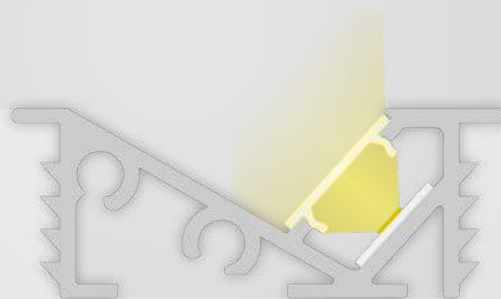

MP1 + C24

max.
6 mm



OEM

GALAXY profiles
Perfect Light Lines



COVERS | ABDECKUNGEN

C24 65 % 200cm 600cm
 8600106 **8600107**

PROFILE

MP1  200 cm  200 cm  200 cm
 8123168 **8123170** **8123169**

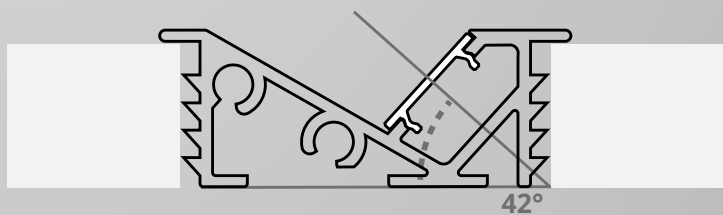
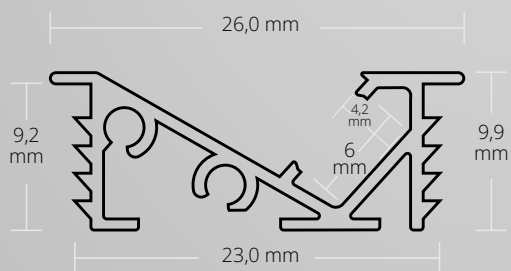
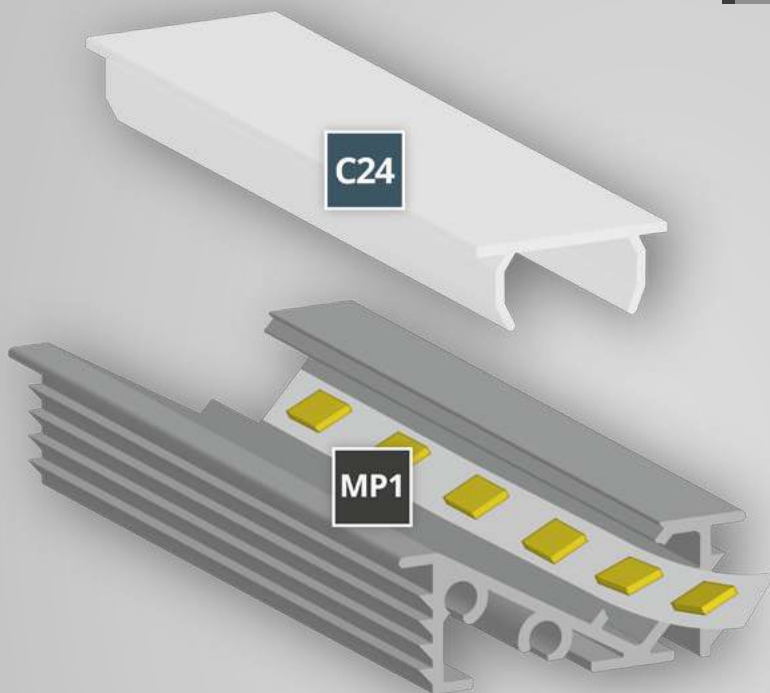



MP1 RECESSED | EINBAU

Möbelprofil | Furniture profile | LED Strips max. 6 mm
26,0 mm x 9,9 mm | 155 g/m

200 cm
8123168

200 cm
8123170

200 cm
8123169

max.
6 mm



OEM

COVERS | ABDECKUNGEN

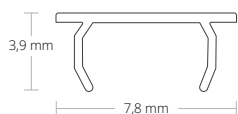

C24 opal | opal | 65 %

PC | 7,8 mm x 3,9 mm

200cm

8600106

600cm

8600107

MP2

SURFACE | AUFBAU

200 cm

max. 6 mm

OEM

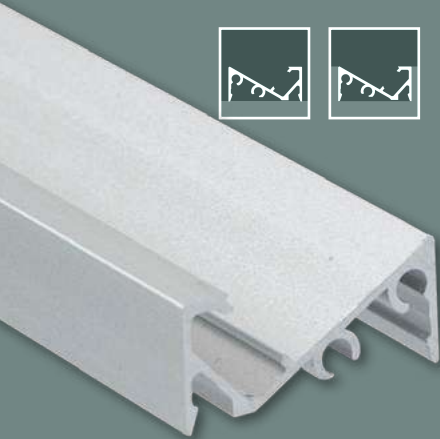

EXTENSION OF SERVICE LIFE
VERLÄNGERUNG LEBENSDAUER

MECHANICAL PROTECTION
MECHANISCHER SCHUTZ

COOLING
KÜHLUNG

HIGH LIGHT UTILISATION
HOHE LICHTVERWERTUNG

HOMOGENEOUS LIGHT
HOMOGENES LICHT

HOMOGENEOUS LIGHT with modular LED light solutions

- Wall, ceiling or floor mounting
Wand-, Decken- oder Bodenmontage
- Residential and office furniture
Wohn- und Büromöbel
- Furniture for business equipment
Möbel für Geschäftsausstattung
- Home accessories
Wohnaccessoires
- Stairs and railings
Treppenstufen und -Geländer
- Balustrades | Balustraden
- Façades, balconies and terraces
Fassaden, Balkone und Terrassen
- Living spaces | Wohnräume
- Offices | Büroräume
- Hotel and gastronomy business
Hotellerie und Gastronomie
- Retail (shop and showcase windows)
Einzelhandel (Shop- und Schaufenster)
- Business areas and showrooms
Geschäftsflächen und Showrooms
- Barber / Beauty / body art studios
Friseur-/Beauty-/Body-Art-Studios
- Halls, foyers and corridors
Hallen, Foyers und Flure
- Wellness and indoor leisure facilities
Wellness- und Indoor-Freizeitanlagen
- Wet rooms | Nasszellen

Mounting/installation on/in wood Strips and plates, plasterboard, tiles, stone, granite, marble and metal surfaces
Montage/Einbau auf/in Holzleisten und -platten, Gipsplatten, Fliesen, Stein-, Granit-, Marmor- und Metalloberflächen

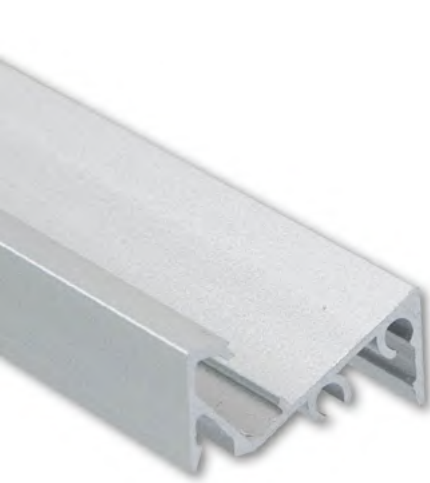

MP2

SURFACE | AUFBAU

Möbelprofil | Furniture profile | LED Strips max. 6 mm

 Silver/Silber
ANODIZED | ELOXIERT

 RAL 9010 White/Weiß
POWDER-COATED | PULVERBESCHICHTET

 RAL 9005 Black/Schwarz
POWDER-COATED | PULVERBESCHICHTET

max.
6 mm



OEM

The MP2 LED RECESSED profile has a particularly narrow and flat design, is designed for LED flex Strips with a maximum width of 6 mm and is used universally indoors. This aluminium profile can also be used for application-specific installation.

The profile is also available in white and black. The LED profile cover opal/satinised (translucency 65 % - also available 600 cm) is made of shatter-proof and non-flammable polycarbonate (classification flammability UL94 V-2) and create homogeneous LED lighting conditions with high utilisation of the light output.

This LED profiles are ideally suited as a LED light source in residential and office furniture, home accessories, display cases, shelves and stairs and of course on walls and ceilings, among other things, due to their small dimensions and low weight.

* Classification flammability UL94 V-2: Extinguishing of a vertically clamped sample within 30 seconds.

Das MP2 LED AUFBAU-Profil hat ein besonders schmales und flaches Design, ist für LED Flexbänder mit einer maximalen Breite von 6 mm konzipiert und wird universell im Innenbereich eingesetzt. Dieses Alu-Profil kann auch eingebaut werden.

Das Profil ist auch in die Farben weiß und schwarz verfügbar.

Die LED Profilabdeckung Opal/satiniert (Lichtdurchlässigkeit 65 % - auch 600 cm erhältlich) besteht aus bruchsicherem und schwer brennbarem Polycarbonat (Klassifizierung Brennbarkeit UL94 V-2) und schaffen homogene LED Lichtverhältnisse mit hoher Verwertung der Lichtleistung.

Aufgrund der kleinen Abmessungen und des geringen Gewichtes sind diese LED Profile unter anderem als ideale LED Lichtquelle in Wohn- und Büromöbeln, Wohnaccessoires, Vitrinen, Regalen sowie an Treppenstufen und selbstverständlich an Wänden und Decken geeignet.

*Klassifizierung Brennbarkeit UL94 V-2: Verlöschen einer vertikal eingespannten Probe innerhalb von 30 Sekunden.

GALAXY profiles
Perfect Light Lines

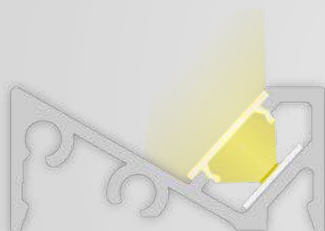

MP2 + C24

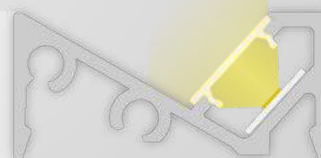

MP2 + C24

max.
6 mm

OEM

GALAXY profiles
Perfect Light Lines



COVERS | ABDECKUNGEN

C24 65 % 200cm 8600106 600cm 8600107

PROFILE

MP2 200 cm 8123171 200 cm 8123173 200 cm 8123172

Z37 8123202

END CAPS | ENDKAPPEN

E95 E95 8123197 E95 8123199 E95 8123198

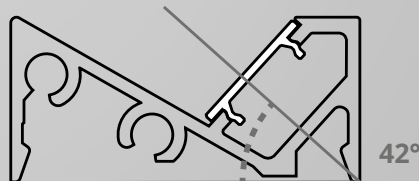
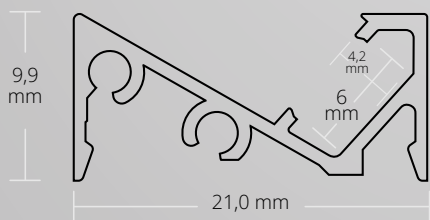
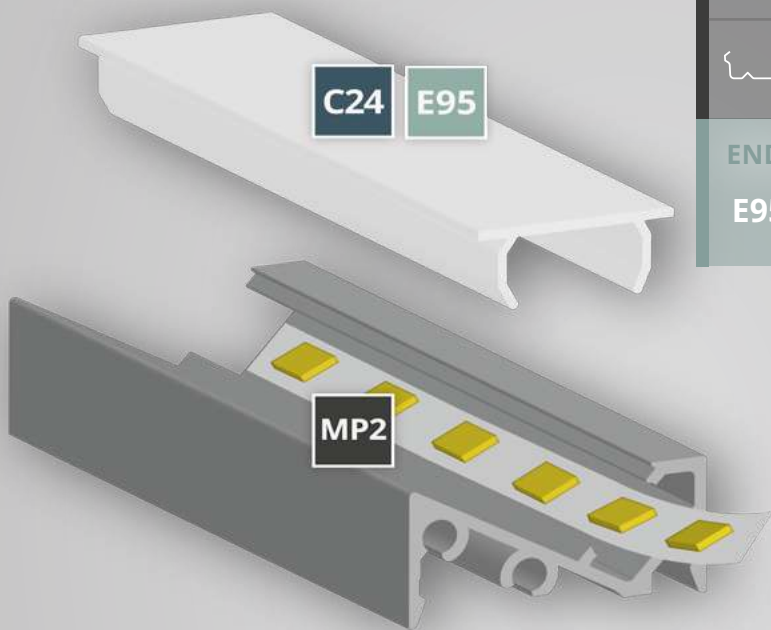



MP2 SURFACE | AUFBAU

Möbelprofil | Furniture profile | LED Strips max. 6 mm
21,0 mm x 9,9 mm | 153 g/m

200 cm 8123171 200 cm 8123173 200 cm 8123172



Z37
Mounting Clips
Montageklammer
Sheet steel | Stahlblech
8123202

max.
6 mm



OEM

COVERS | ABDECKUNGEN

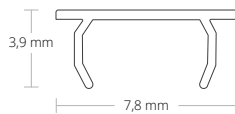

C24 opal | opal | 65 %
PC | 7,8 mm x 3,9 mm
200cm 8600106 600cm 8600107

END CAPS | ENDKAPPEN



E95 ALUMINIUM | 2 PCS/STK
E95 8123197 E95 8123199 E95 8123198

MP3

SURFACE | AUFBAU

200 cm

max. 10 mm

OEM



EXTENSION OF SERVICE LIFE
VERLÄNGERUNG LEBENSDAUER

MECHANICAL PROTECTION
MECHANISCHER SCHUTZ

COOLING
KÜHLUNG

HIGH LIGHT UTILISATION
HOHE LICHTVERWERTUNG

HOMOGENEOUS LIGHT
HOMOGENES LICHT

HOMOGENEOUS LIGHT with modular LED light solutions

- Residential and office furniture
Wohn- und Büromöbel
- Furniture for business equipment
Möbel für Geschäftsausstattung
- Home accessories
Wohnaccessoires
- Cabinet doors | Schranktüren
- Display cases | Vitrinen
- Shelves | Regale
- Living spaces | Wohnräume
- Offices | Büroräume
- Hotel and gastronomy business
Hotellerie und Gastronomie
- Retail (shop and showcase windows)
Einzelhandel (Shop- und Schaufenster)
- Business areas and showrooms
Geschäftsflächen und Showrooms
- Barber / Beauty / body art studios
Friseur-/Beauty-/Body-Art-Studios
- Wellness and indoor leisure facilities
Wellness- und Indoor-Freizeitanlagen

Mounting on wood Strips and plates, plasterboard, tiles, stone, granite, marble and metal surfaces
Montage auf Holzleisten und -platten, Gipsplatten, Fliesen, Stein-, Granit-, Marmor- und Metalloberflächen



MP3

SURFACE | AUFBAU

Möbelprofil | Furniture profile | LED Strips max. 10 mm

□ RAL 9010 White/Weiß
POWDER-COATED | PULVERBESCHICHTET

■ RAL 9005 Black/Schwarz
POWDER-COATED | PULVERBESCHICHTET



max. 10 mm

The MP3 LED FURNITURE profile is a compact surface-mounted profile with a particularly slim design and is suitable for LED flex strips with a maximum width of 10 mm. Thanks to its flat design, it can be used almost invisibly in cupboards, display cabinets, shelves or other pieces of furniture, providing subtle, indirect lighting. The profile is available in white and black.

Thanks to its small dimensions and simple adhesive mounting, the MP3 profile is an ideal LED light source for furniture, home accessories and interior fittings, but can also be used flexibly on walls and ceilings.

Das MP3 LED MÖBEL-Profil ist ein kompaktes Aufbauprofil mit besonders schmalen Design und eignet sich für LED Flexbänder mit einer maximalen Breite von 10 mm. Durch die flache Bauweise kann es nahezu unsichtbar in Schränken, Vitrinen, Regalen oder anderen Möbelstücken eingesetzt werden und sorgt dort für eine dezente, indirekte Beleuchtung. Das Profil ist in den Farben weiß und schwarz erhältlich.

Dank seiner geringen Abmessungen und der einfachen Befestigung per Klebmontage ist das MP3-Profil eine ideale LED-Lichtquelle für Möbel, Wohnaccessoires und Innenausbauten, lässt sich aber ebenso flexibel an Wänden und Decken einsetzen.

GALAXY profiles
Perfect Light Lines



MP3

max.
10 mm

GALAXY profiles
Perfect Light Lines



OEM

PROFILE

MP3

200 cm
8123545

200 cm
8123544

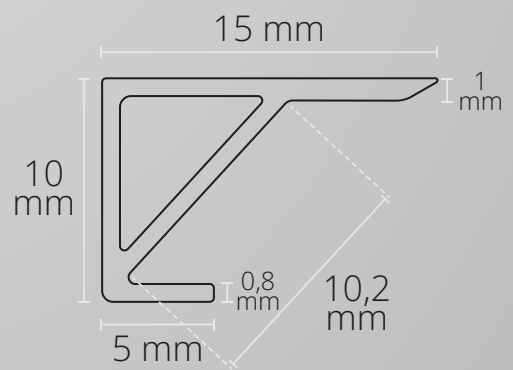
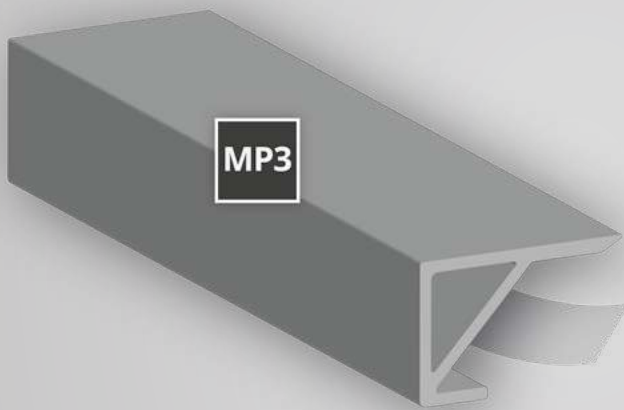



MP3 SURFACE | AUFBAU

Möbelprofil | Furniture profile | LED Strips max. 10 mm

15,0 mm x 10 mm | 86 g/m

200 cm
8123545

200 cm
8123544

max.
10 mm



OEM

 **INSTALLATION INSTRUCTION**
INSTALLATIONS MONTAGE

MP4

SURFACE | AUFBAU

200 cm

max. 10 mm

OEM

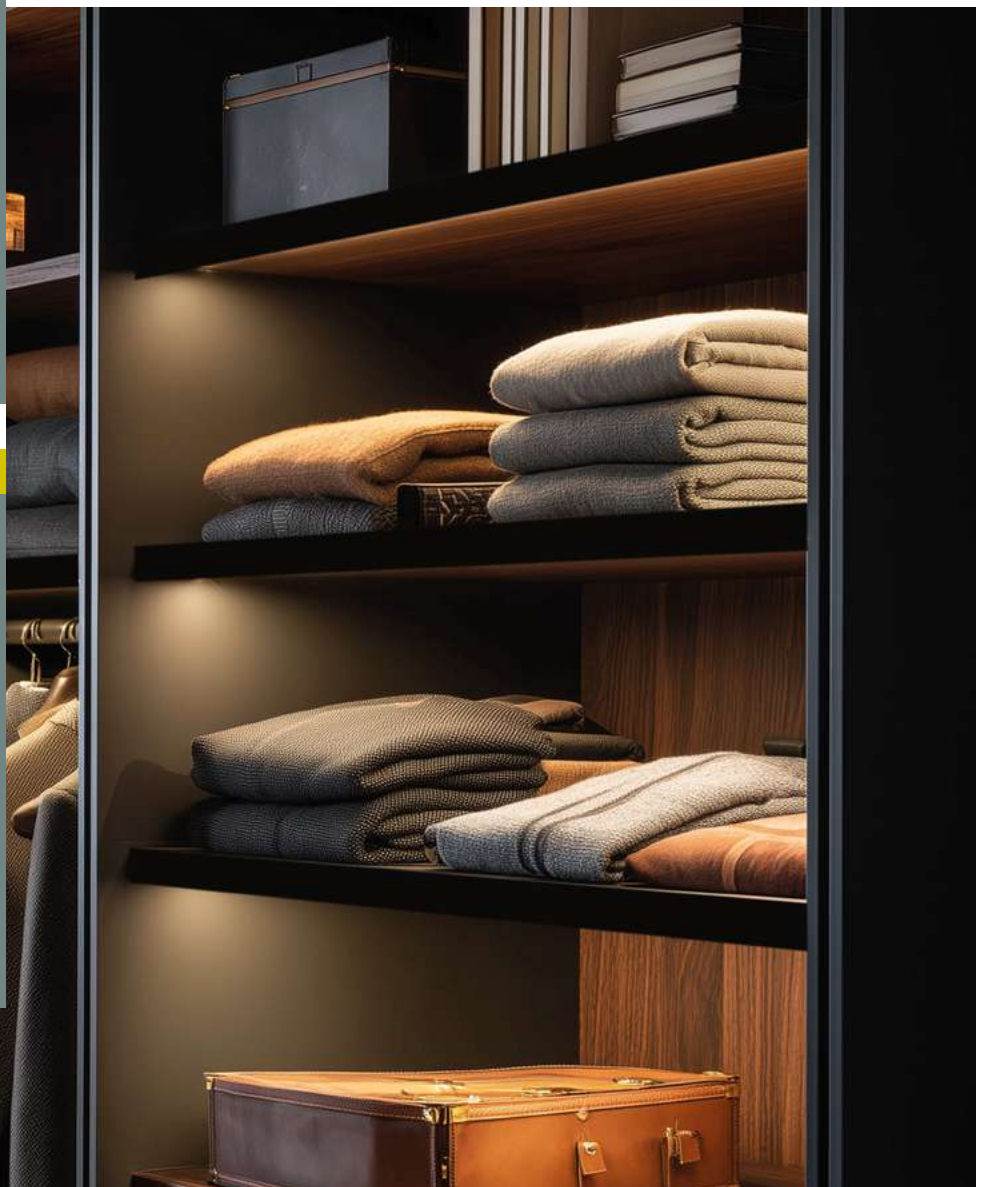

EXTENSION OF SERVICE LIFE
VERLÄNGERUNG LEBENSDAUER

MECHANICAL PROTECTION
MECHANISCHER SCHUTZ

COOLING
KÜHLUNG

HIGH LIGHT UTILISATION
HOHE LICHTVERWERTUNG

HOMOGENEOUS LIGHT
HOMOGENES LICHT

HOMOGENEOUS LIGHT with modular LED light solutions

- Residential and office furniture
Wohn- und Büromöbel
- Furniture for business equipment
Möbel für Geschäftsausstattung
- Home accessories
Wohnaccessoires
- Cabinet doors | Schranktüren
- Display cases | Vitrinen
- Shelves | Regale
- Living spaces | Wohnräume
- Offices | Büroräume
- Hotel and gastronomy business
Hotellerie und Gastronomie
- Retail (shop and showcase windows)
Einzelhandel (Shop- und Schaufenster)
- Business areas and showrooms
Geschäftsflächen und Showrooms
- Barber / Beauty / body art studios
Friseur-/Beauty-/Body-Art-Studios
- Wellness and indoor leisure facilities
Wellness- und Indoor-Freizeitanlagen

Mounting on wood Strips and plates, plasterboard, tiles, stone, granite, marble and metal surfaces
Montage auf Holzleisten und -platten, Gipsplatten, Fliesen, Stein-, Granit-, Marmor- und Metalloberflächen



MP4

SURFACE | AUFBAU

Möbelprofil | Furniture profile | LED Strips max. 10 mm

□ RAL 9010 White/Weiß
POWDER-COATED | PULVERBESCHICHTET

■ RAL 9005 Black/Schwarz
POWDER-COATED | PULVERBESCHICHTET



max. 10 mm

The MP4 furniture profile was specially designed for illuminating cupboard compartments and, in addition to providing a lighting solution, also serves as an edge for the shelves. The profile fits a flexible strip with a maximum width of 10 mm. The profile can be fixed to the edge of the shelf using a suitable mounting adhesive.

The high-quality aluminium profile ensures even illumination throughout the entire wardrobe. Thanks to its delicate dimensions, the profile blends inconspicuously into the wardrobe and does not take up any space.

The MP4 is ideal for installation in furniture such as wardrobes, shelves or cabinet systems. The illumination of the wardrobe not only improves orientation, but also makes it easier to keep things tidy and maintain an overview.

Das MP4 Möbelprofil wurde eigens für die Ausleuchtung von Schrankfächern konzipiert und dient neben einer Beleuchtungslösung auch als Kante für die Regalbretter. In das Profil passt ein Flexband mit einer maximalen Breite von 10 mm. Das Profil kann mit einem geeigneten Montagekleber an der Brettkante fixiert.

Das hochwertige Aluminiumprofil sorgt für eine flächige Ausleuchtung im gesamten Kleiderschrank. Dank der filigranen Bemaßungen fügt sich das Profil unauffällig in den Schrank ein und nimmt keinen Platz weg.

Das MP4 eignet sich bestens für den Einbau in Möbel, wie Kleiderschränke, Regale oder Schranksysteme. Die Ausleuchtung des Kleiderschranks verbessert nicht nur die Orientierung, sondern erleichtert es auch Ordnung zu halten und den Überblick zu bewahren.

GALAXY profiles
Perfect Light Lines

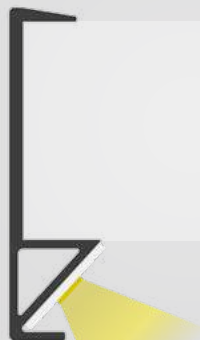

MP4

max.
10 mm

GALAXY profiles
Perfect Light Lines



OEM



PROFILE

MP4

200 cm
8123547

200 cm
8123546

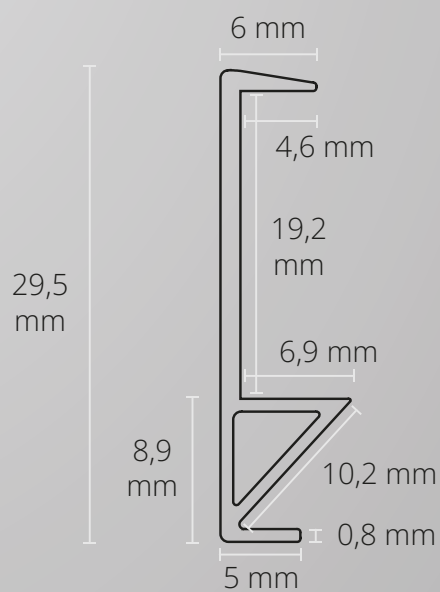
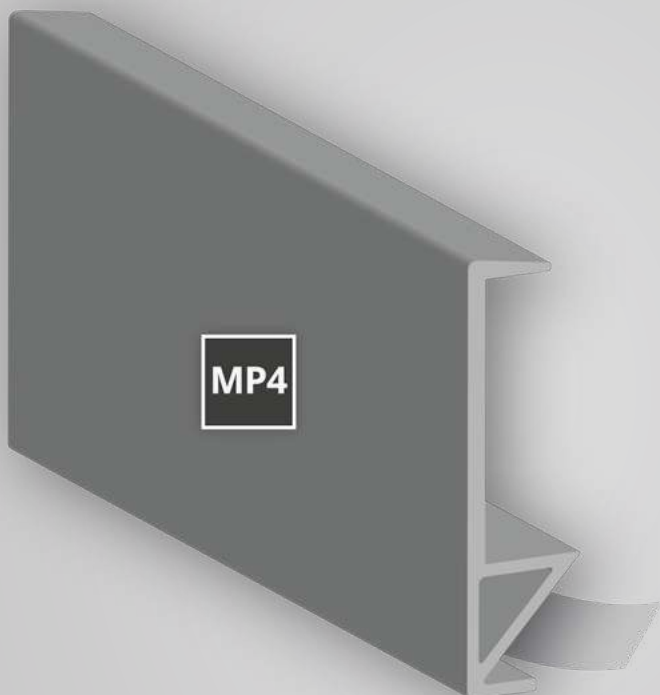



MP4 SURFACE | AUFBAU

Möbelprofil | Furniture profile | LED Strips max. 10 mm

6,9 mm x 29,5 mm | 86 g/m

□ 200 cm
8123547

■ 200 cm
8123546

max.
10 mm



OEM

INSTALLATION INSTRUCTION
INSTALLATIONS MONTAGE

MP4

BP2

RECESSED | EINBAU

200 cm

max. 12 mm

OEM

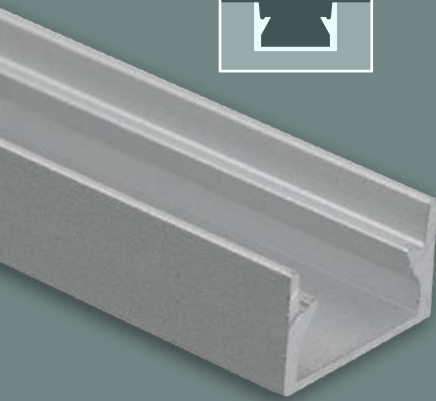

EXTENSION OF SERVICE LIFE
VERLÄNGERUNG LEBENSDAUER

MECHANICAL PROTECTION
MECHANISCHER SCHUTZ

COOLING
KÜHLUNG

HIGH LIGHT UTILISATION
HOHE LICHTVERWERTUNG

HOMOGENEOUS LIGHT
HOMOGENES LICHT

HOMOGENEOUS LIGHT with modular LED light solutions

- Floor mounting
Bodenmontage
- Stairs and railings
Treppenstufen und -Geländer
- Balustrades | Balustraden
- Façades, balconies and terraces
Fassaden, Balkone und Terrassen
- Living spaces | Wohnräume
- Offices | Büroräume
- Hotel and gastronomy business
Hotellerie und Gastronomie
- Retail (shop and showcase windows)
Einzelhandel (Shop- und Schaufenster)
- Business areas and showrooms
Geschäftsflächen und Showrooms
- Barber / Beauty / body art studios
Friseur-/Beauty-/Body-Art-Studios
- Halls, foyers and corridors
Hallen, Foyers und Flure
- Wellness and indoor leisure facilities
Wellness- und Indoor-Freizeitanlagen
- Wet rooms | Nasszellen

Mounting/installation on/in wood Strips and plates, plasterboard, tiles, stone, granite, marble and metal surfaces
Montage/Einbau auf/in Holzleisten und -platten, Gipsplatten, Fliesen, Stein-, Granit-, Marmor- und Metalloberflächen



BP2

RECESSED | EINBAU

Begehbar | Walkable | LED Strips max. 12 mm

Silver/Silber
ANODIZED | ELOXIERT



max. 12 mm

Made of high-quality aluminium, this recessed profile is particularly suitable for indoor lighting designs integrated into the floor.

The BP2 is available in silver, has an overall height of 10 mm and is suitable for LED flex Strips with a maximum width of 12 mm.

The LED profile covers opal/satin (light transmittance 65 %) are made of shatterproof and flame-retardant polycarbonate (flammability classification UL94 V-2) and create homogeneous LED lighting conditions with high utilisation of the light output.

* Classification flammability UL94 V-2: Extinguishing of a vertically clamped sample within 30 seconds.

Aus hochwertigem Aluminium hergestellt ist dieses Einbauprofil besonders für, in den Boden integrierte Lichtdesigns, in Innenbereichen geeignet. Es ist begehbar und kann nahtlos in den Boden eingelassen werden.

Das BP2 ist in Silber verfügbar, hat eine Gesamthöhe von 10 mm und eignet sich für LED Flexbänder mit einer maximalen Breite von 12 mm.

Die LED Profilabdeckungen Opal/satiniert (Lichtdurchlässigkeit 65 %) bestehen aus bruchsicherem und schwer brennbarem Polycarbonat (Klassifizierung Brennbarkeit UL94 V-2) und schaffen homogene LED Lichtverhältnisse mit hoher Verwertung der Lichtleistung.

*Klassifizierung Brennbarkeit UL94 V-2: Verlöschen einer vertikal eingespannten Probe innerhalb von 30 Sekunden.

GALAXY profiles
Perfect Light Lines

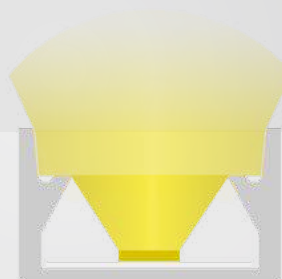

BP2 + C57

max.
12 mm

GALAXY profiles
Perfect Light Lines

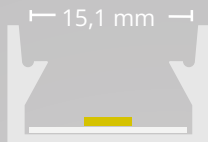

OEM

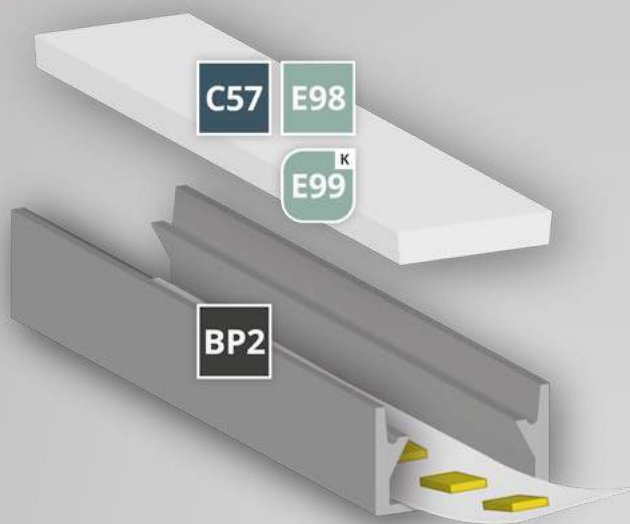

COVERS | ABDECKUNGEN

C57 65 % 200cm
8600137

PROFILE

BP2 200cm
8102083

END CAPS | ENDKAPPEN

E98 E98
8304014

E99 E99
8304047

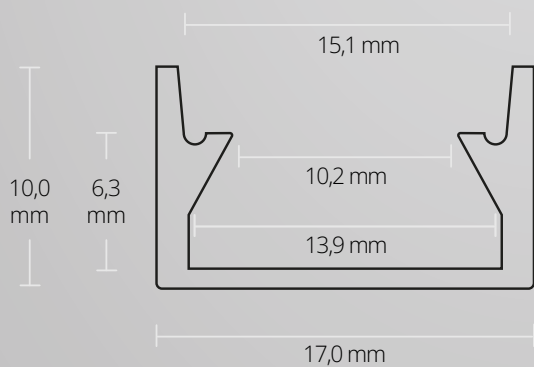



BP2 RECESSED | EINBAU

Begehbar | Walkable | LED Strips max. 12 mm
17,0 mm x 10,0 mm | 110 g/m

200 cm
8102083

max.
12 mm



OEM

COVERS | ABDECKUNGEN



C57 opal | opal
PC | 14,1 mm x 2,8 mm
200cm
8600137

END CAPS | ENDKAPPEN



E98 PETG | 1 PCS/STK

E98
8304014



E99 PETG | ROUND/RUND | 1 PCS/STK

E99
8304047

PA3

RECESSED | EINBAU

200 cm

max. 16 mm

OEM

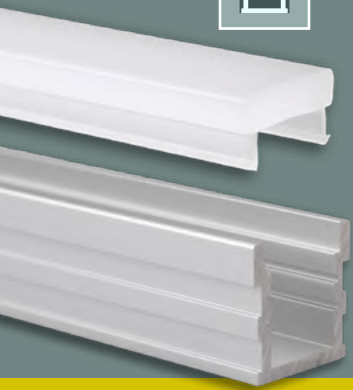

NEW TO OUR RANGE
IM SORTIMENT

EXTENSION OF SERVICE LIFE
VERLÄNGERUNG LEBENSDAUER

MECHANICAL PROTECTION
MECHANISCHER SCHUTZ

COOLING
KÜHLUNG

HIGH LIGHT UTILISATION
HOHE LICHTVERWERTUNG

HOMOGENEOUS LIGHT
HOMOGENES LICHT

HOMOGENEOUS LIGHT with modular LED light solutions

- Stairs | Treppenstufen
- Balconies and terraces
Balkone und Terrassen
- Hotel and gastronomy business
Hotellerie und Gastronomie
- Business areas and showrooms
Geschäftsflächen und Showrooms
- Halls, foyers and corridors
Hallen, Foyers und Flure
- Garages & Car repair shops
Garagen & KFZ-Werkstätte
- Garden | Garten
- Driveways | Hauseinfahrten
- Sidewalks | Gehwege
- Outdoor facilities | Außenanlagen
- Amusement parks | Freizeitparks
- Fairgrounds | Messegelände

Our new passable recessed floor profile combines resilience, functionality and aesthetics – ideal for driveways, garages and outdoor areas.

Unser neues befahrbares Bodeneinbauprofil vereint Belastbarkeit, Funktion und Ästhetik – ideal für Einfahrten, Garagen, Außenanlagen oder öffentliche Innenräume.



PA3

RECESSED | EINBAU

Befahrbar | Passable | LED Strips max. 16 mm

Silver/Silber
ANODIZED | ELOXIERT



max. 16 mm

The PA3 recessed profile made of robust aluminium is ideal for indoor and outdoor use. The profile can be illuminated with a flexible strip up to 16 mm wide.

The opal cover clicks into place without tools – no gluing or sealing is necessary. A protective film applied at the factory protects the cover from scratches during installation. The PA3 profile is easy to maintain, as the cover can be removed at any time and the interior remains easily accessible. The corresponding cover is included in the set. This makes the profile ideal for use in driveways, terraces or walkways, where lighting and load-bearing capacity are equally important.

The profile is walkable and driveable and has been designed to meet the requirements of load class A 15 (≈ 1.5 t surface load). It can be installed in the ground and can even withstand the weight of a car.

Thanks to optional foam drainage or a drainage option provided by the customer, the PA3 is UV-stable and frost-resistant for outdoor use.

The result is atmospheric and functional lighting that safely illuminates paths and driveways while adding elegant accents to outdoor areas.

Das PA3 Einbauprofil aus robustem Aluminium ist bestens geeignet für den Innen- und Außenbereich. Mit einem Flexband mit einer Breite von bis zu 16 mm kann das Profil zum Leuchten gebracht werden.

Das opale Cover wird werkzeuglos eingeklickt – ein Verkleben oder Abdichten ist nicht nötig. Eine Schutzfolie ab Werk bewahrt das Cover beim Einbau vor Kratzern. Das PA3 Profil ist wartungsfreundlich, da das Cover jederzeit entnehmbar ist und das Innenleben leicht zugänglich bleibt. Im Set ist das dazugehörige Cover enthalten. Damit eignet sich das Profil ideal für den Einsatz in Einfahrten, Terrassen oder Gehwegen, wo Beleuchtung und Belastbarkeit gleichermaßen gefragt sind.

Das Profil ist begeh- und befahrbar und wurde nach den Anforderungen der Belastungsklasse A 15 (≈ 1,5 t Flächenlast) konstruiert. Es kann im Boden eingebaut werden und hält damit sogar einem PKW stand.

Durch eine optionale Schaumstoff-Drainage oder eine bauseitige Sickermöglichkeit ist das PA3 UV-stabil und frostbeständig im Außenbereich.

So entsteht eine stimmungsvolle und funktionale Beleuchtung, die Wege und Einfahrten sicher ausleuchtet und zugleich elegante Akzente im Außenbereich setzt.

GALAXY profiles
Perfect Light Lines

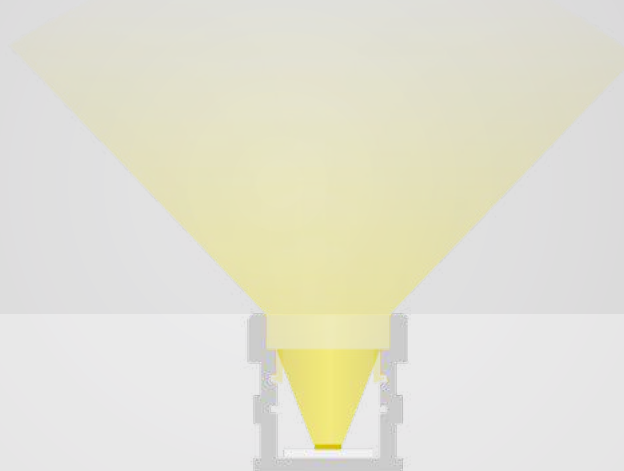

PA3 + C70

max.
16 mm

GALAXY profiles
Perfect Light Lines

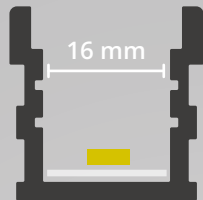

OEM

PROFILE

PA3 200cm
8123598

COVER INCLUDED IN THE SET
ABDECKUNG IM SET ENTHALTEN

END CAPS | ENDKAPPEN

E134 E134
8123599

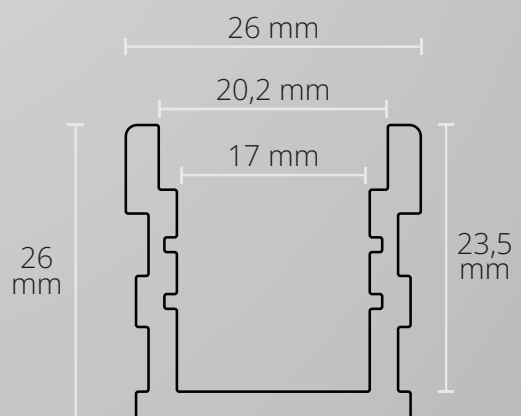
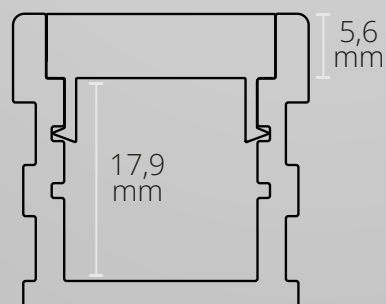
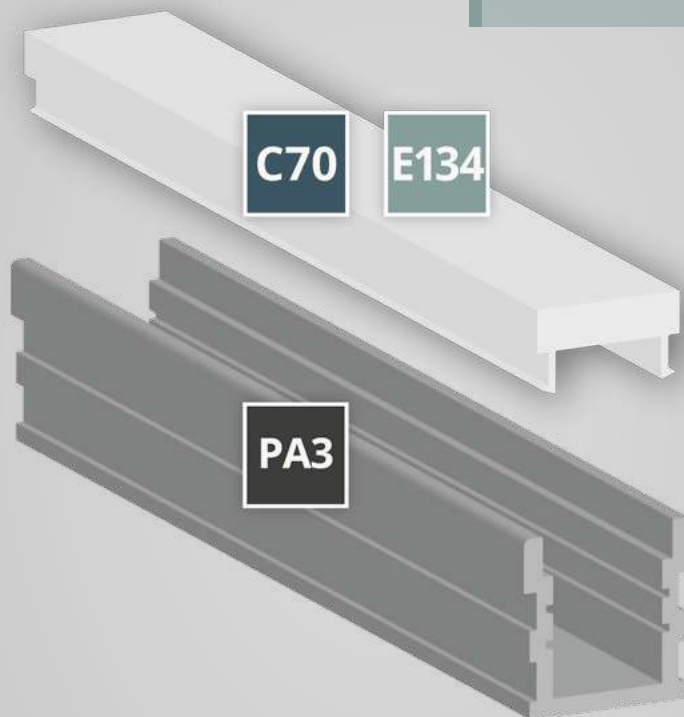



PA3 RECESSED | EINBAU NEW

Begehbar | Walkable | LED Strips max. 16 mm

16,80 mm x 5,91 mm | 115 g/m

200 cm
8123598

max.
16 mm



OEM

COVERS | ABDECKUNGEN

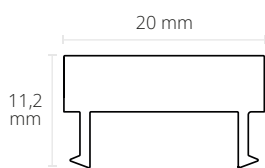

IM SET ENTHALTEN

opal | opal

PC | 20 mm x 11,2 mm

END CAPS | ENDKAPPEN



E134 PVC | 2 PCS/STK + 1 PCS/STK WITH CABLE GLAND | MIT KABELDURCHFÜHRUNG

E134
8123599

NEW



Z70 Foam | Schaumstoff

100 cm
8123607

NEW



INSTALLATION INSTRUCTION
INSTALLATIONS MONTAGE

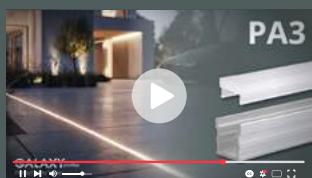



PA3

Das befahrbare Bodeneinbauprofil PA3 ist die ideale Lösung für moderne Bodeninstallationen. Es überzeugt durch seine robuste Konstruktion, die auch in verschiedenen Bereichen wie Garagen, Einfahrten oder Parkplätze dauerhaft belastbar bleibt.



INSTALLATION IS SIMPLE AND WELL THOUGHT OUT: DIE MONTAGE IST EINFACH UND DURCHDACHT:



Start by wiring the profile.
Beginnen Sie mit der Verkabelung des Profils.

When installing in cobblestones, first fill the inlet opening with jointing sand so that rainwater can drain away without any problems.



Bei der Installation in Kopfsteinpflaster füllen Sie die Einlassöffnung zunächst mit Fugensand, damit Regenwasser problemlos absickern kann.

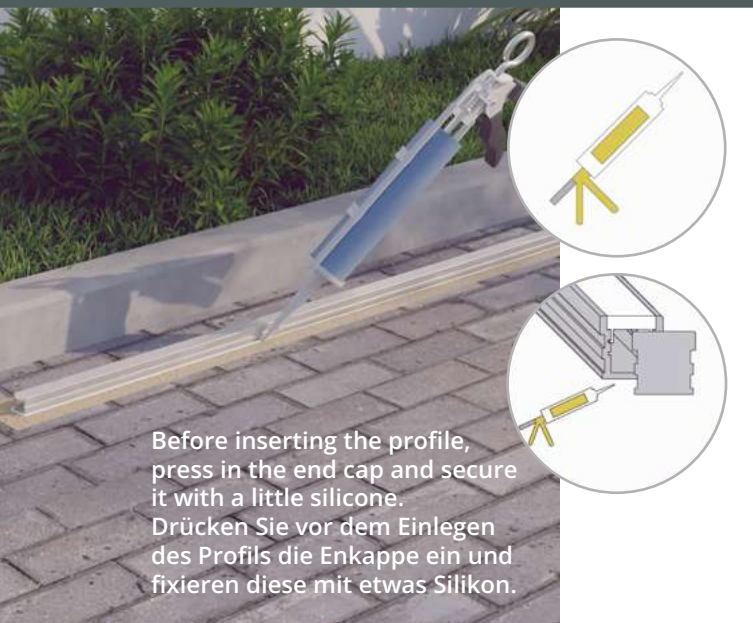

Before inserting the profile, press in the end cap and secure it with a little silicone.
Drücken Sie vor dem Einlegen des Profils die Enkappe ein und fixieren diese mit etwas Silikon.



Then insert the profile, secure it with a little silicone and press the cover into the profile.
Legen Sie anschließend das Profil ein, fixieren Sie es mit etwas Silikon und drücken Sie das Cover in das Profil.

When installing in asphalt, also start with the cabling. Before inserting the profile, place a foam drainage in the opening to prevent waterlogging. Then insert the profile, seal it all around with silicone and press in the cover.

Beim Einbau in Asphalt starten Sie ebenfalls mit der Verkabelung. Geben Sie vor dem Einlegen eine Schaumstoff-Drainage in die Öffnung, um Staunässe zu vermeiden. Danach das Profil einsetzen, rundherum mit Silikon abdichten und das Cover eindrücken.

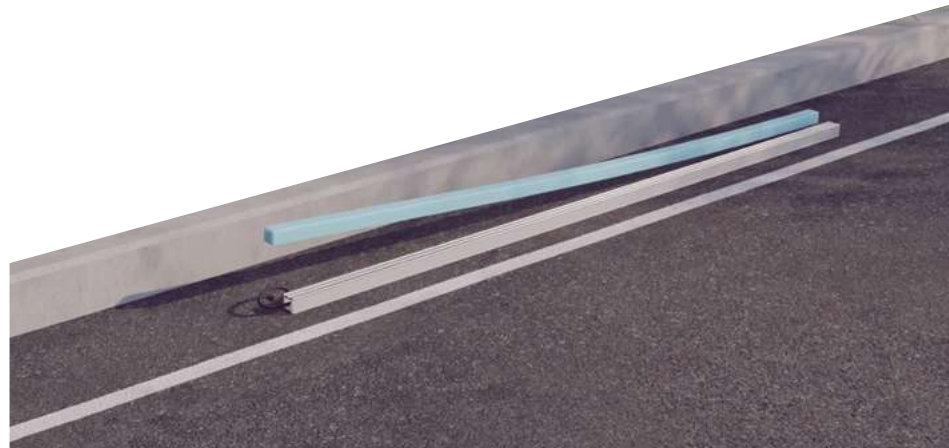

DISCOVER VARIOUS APPLICATIONS IN OUR VIDEO ABOUT THE PA3 PROFILE!

ENTDECKEN SIE VERSCHIEDENE ANWENDUNGEN IN UNSEREM VIDEO ÜBER DAS PA3 PROFIL!

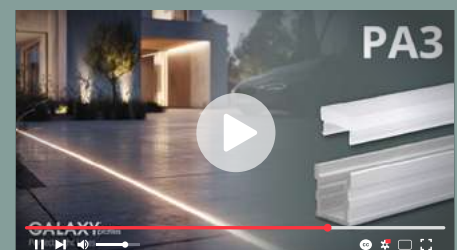
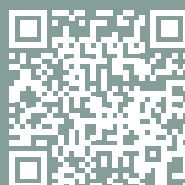

WP1

CORNER | ECK

200 cm

max. 18 mm

OEM

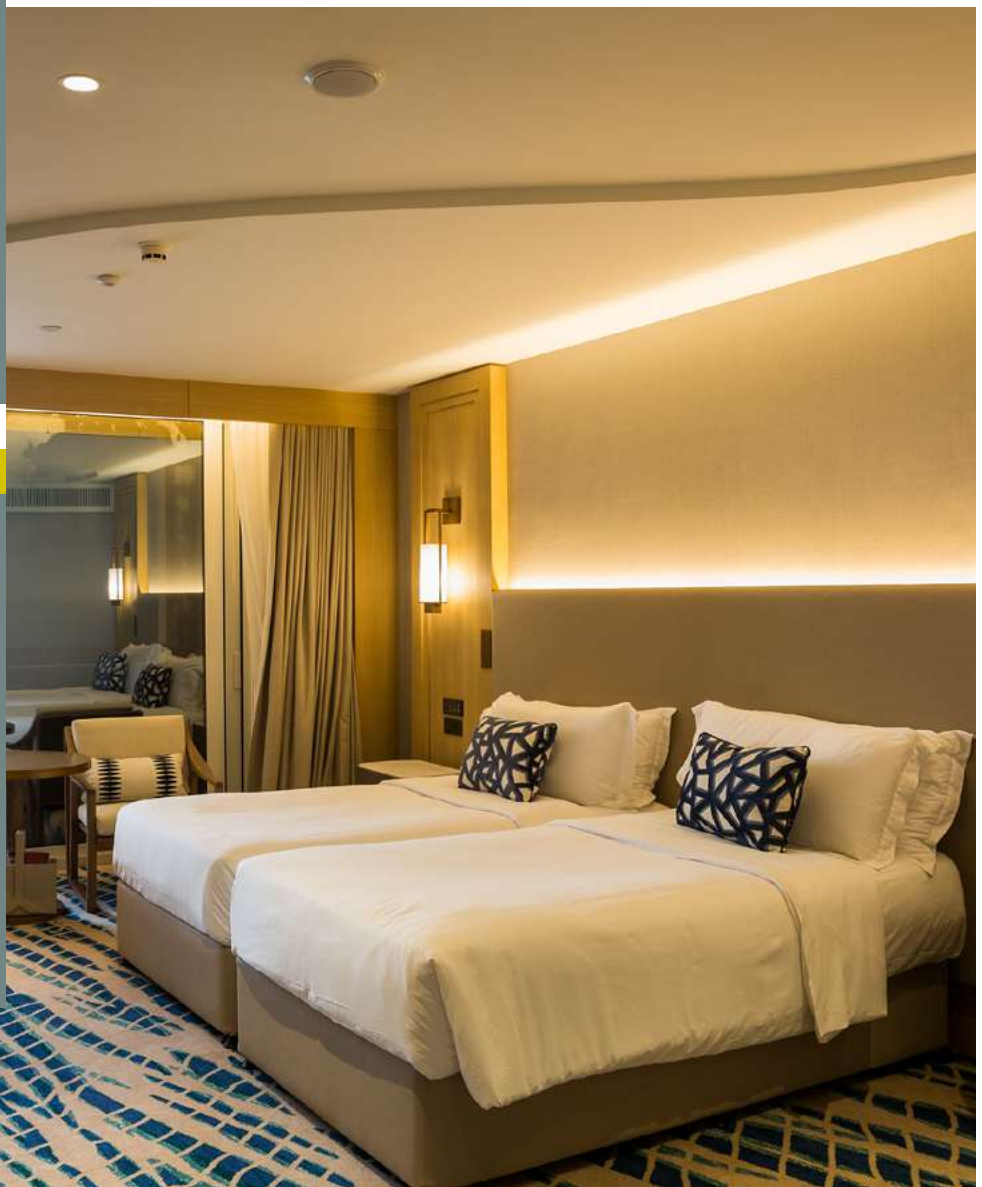

EXTENSION OF SERVICE LIFE
VERLÄNGERUNG LEBENSDAUER

MECHANICAL PROTECTION
MECHANISCHER SCHUTZ

COOLING
KÜHLUNG

HIGH LIGHT UTILISATION
HOHE LICHTVERWERTUNG

HOMOGENEOUS LIGHT
HOMOGENES LICHT

HOMOGENEOUS LIGHT with modular LED light solutions

- Wall, ceiling or floor mounting
Wand-, Decken- oder Bodenmontage
- Residential and office furniture
Wohn- und Büromöbel
- Furniture for business equipment
Möbel für Geschäftsausstattung
- Home accessories
Wohnaccessoires
- Mirrors | Spiegel
- Cabinet doors | Schranktüren
- Display cases | Vitrinen
- Shelves | Regale
- Stairs and railings
Treppenstufen und -Geländer
- Balustrades | Balustraden
- Façades, balconies and terraces
Fassaden, Balkone und Terrassen
- Living spaces | Wohnräume
- Offices | Büroräume
- Hotel and gastronomy business
Hotellerie und Gastronomie
- Retail (shop and showcase windows)
Einzelhandel (Shop- und Schaufenster)
- Business areas and showrooms
Geschäftsflächen und Showrooms
- Barber / Beauty / body art studios
Friseur-/Beauty-/Body-Art-Studios
- Halls, foyers and corridors
Hallen, Foyers und Flure
- Wellness and indoor leisure facilities
Wellness- und Indoor-Freizeitanlagen
- Wet rooms | Nasszellen

Mounting/installation on/in wood Strips and plates, plasterboard, tiles, stone, granite, marble and metal surfaces
Montage/Einbau auf/in Holzleisten und -platten, Gipsplatten, Fliesen, Stein-, Granit-, Marmor- und Metalloberflächen



WP1

CORNER | ECK

30°/60° | LED Strips max. 18 mm

□ RAL 9010 White/Weiß
POWDER-COATED | PULVERBESCHICHTET

■ RAL 9005 Black/Schwarz
POWDER-COATED | PULVERBESCHICHTET



max. 18 mm

Versatile mounting and perfect for a wide range of application locations, for example in the kitchen base: This corner profile has different angles (60° and 30°) so that it can be adapted to special mounting conditions. The profile can be used in combination with LED strips up to 18 mm wide.

LED profile covers opal/satinised (light transmittance 65 %) or white/matt (light transmittance 75 %) are made of shatterproof and flame retardant polycarbonate (flammability classification UL94 V-2) and create homogeneous LED lighting conditions with high utilization of light output.

* Classification flammability UL94 V-2: Extinguishing of a vertically clamped sample within 30 seconds

Vielseitig montierbar und perfekt geeignet für die verschiedensten Anwendungsorte, beispielsweise im Küchenunterbau: Dieses Eckprofil verfügt über unterschiedliche Winkel (60° und 30°), damit es an besondere Montagebedingungen angepasst werden kann. Das Profil kann in Kombination mit LED Strips mit bis zu 18 mm Breite verwendet werden.

Die LED Profilabdeckungen Opal/satiniert (Lichtdurchlässigkeit 65 %) oder Weiß/matt (Lichtdurchlässigkeit 75 %) bestehen aus bruchsicherem und schwer brennbarem Polycarbonat (Klassifizierung Brennbarkeit UL94 V-2) und schaffen homogene LED Lichtverhältnisse mit hoher Verwertung der Lichtleistung.

*Klassifizierung Brennbarkeit UL94 V-2: Verlöschen einer vertikal eingespannten Probe innerhalb von 30 Sekunden

GALAXY profiles
Perfect Light Lines



WP1 + C30



WP1 + C30

max.
18 mm

GALAXY profiles
Perfect Light Lines

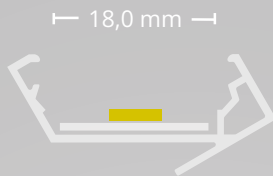

OEM

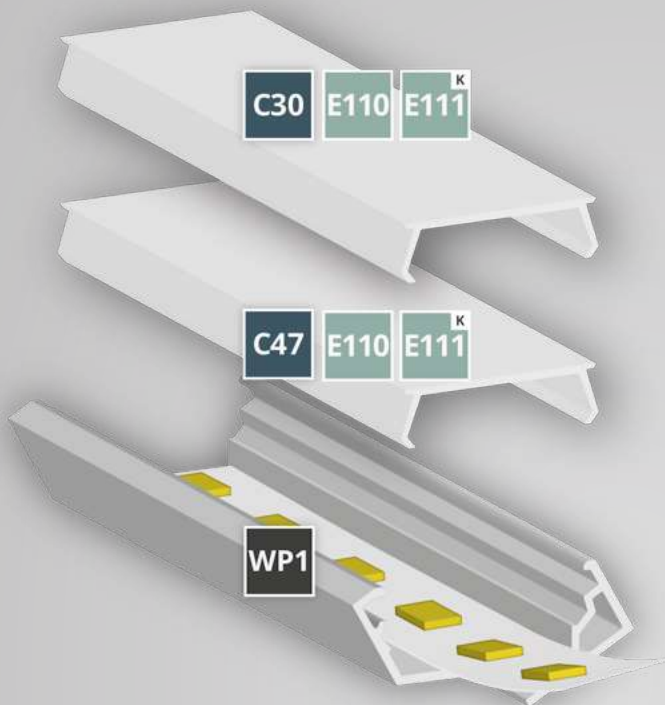

COVERS | ABDECKUNGEN

C30 65 % 200 cm 300 cm
8600077 8600081

C47 75 % 200 cm
8600099

PROFILE

WP1 200 cm 200 cm
8102085 8102084

END CAPS | ENDKAPPEN

E110 E110 E110
8304015 8304016

E111 E111 E111
8304016 8304018

LEFT
LINKS

END CAPS | ENDKAPPEN

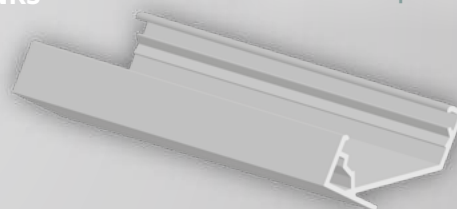

RIGHT
RECHTS

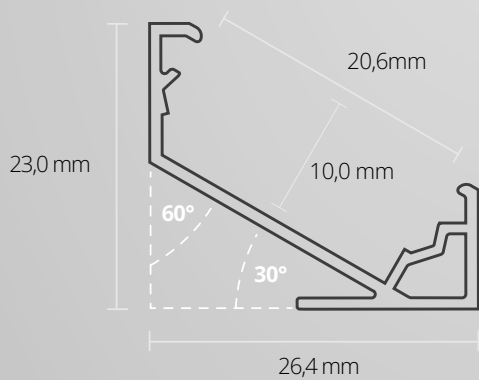



WP1 CORNER | ECK

30°/60° | LED Strips max. 18 mm
26,4 mm x 23,0 mm | 186 g/m

200 cm
8102085

200 cm
8102084

max.
18 mm



OEM

COVERS | ABDECKUNGEN

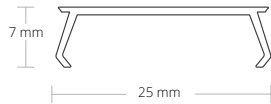

C30 opal | opal | 65 %
PC | 25mm x 7 mm
200cm 300cm
8600077 8600081

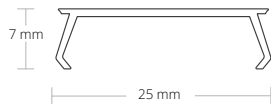

C47 weiß/matt | white/matt | 75 %
PC | 25mm x 7 mm
200cm
8600099

END CAPS | ENDKAPPEN

E110 PETG | 1 PCS/STK

Left | Links



E110L
8304015

E110L
8304016

Right | Rechts



E110R
8304043

E110R
8304044

E111 PETG | 1 PCS/STK | Cable/Kabel

Left | Links



E111L
8304017

E111L
8304018

Right | Rechts

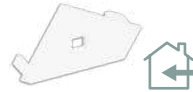

E110R
8304045

E110R
8304046

PK1

SURFACE | AUFBAU

200 cm

max. 12 mm

OEM

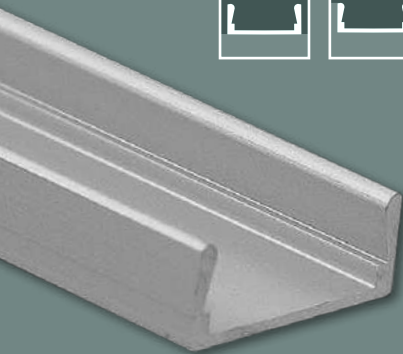

EXTENSION OF SERVICE LIFE
VERLÄNGERUNG LEBENSDAUER

MECHANICAL PROTECTION
MECHANISCHER SCHUTZ

COOLING
KÜHLUNG

HIGH LIGHT UTILISATION
HOHE LICHTVERWERTUNG

HOMOGENEOUS LIGHT
HOMOGENES LICHT

HOMOGENEOUS LIGHT with modular LED light solutions

- Wall, ceiling or floor mounting
Wand-, Decken- oder Bodenmontage
- Residential and office furniture
Wohn- und Büromöbel
- Furniture for business equipment
Möbel für Geschäftsausstattung
- Home accessories
Wohnaccessoires
- Mirrors | Spiegel
- Cabinet doors | Schranktüren
- Display cases | Vitrinen
- Shelves | Regale
- Stairs and railings
Treppenstufen und -Geländer
- Balustrades | Balustraden
- Façades, balconies and terraces
Fassaden, Balkone und Terrassen
- Living spaces | Wohnräume
- Offices | Büroräume
- Hotel and gastronomy business
Hotellerie und Gastronomie
- Retail (shop and showcase windows)
Einzelhandel (Shop- und Schaufenster)
- Business areas and showrooms
Geschäftsflächen und Showrooms
- Barber / Beauty / body art studios
Friseur-/Beauty-/Body-Art-Studios
- Halls, foyers and corridors
Hallen, Foyers und Flure
- Wellness and indoor leisure facilities
Wellness- und Indoor-Freizeitanlagen
- Wet rooms | Nasszellen

Mounting/installation on/in wood Strips and plates, plasterboard, tiles, stone, granite, marble and metal surfaces
Montage/Einbau auf/in Holzleisten und -platten, Gipsplatten, Fliesen, Stein-, Granit-, Marmor- und Metalloberflächen

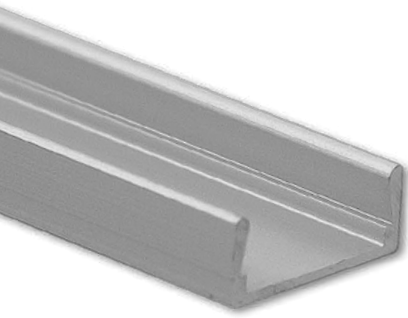

PK1

SURFACE | AUFBAU

flat | flach | LED Strips max. 12 mm

 Silver/Silber
ANODIZED | ELOXIERT

 RAL 9010 White/Weiß
POWDER-COATED | PULVERBESCHICHTET

 RAL 9005 Black/Schwarz
POWDER-COATED | PULVERBESCHICHTET

max.
12 mm



OEM



max. 12 mm

The PK1 LED SURFACE profile has a particularly slim and flat design, is designed for LED flex strips with a maximum width of 12 mm. This aluminium profile can also be used for recessed installation.

The profile covers (opal/satinised - 65 % transparency clear - 85 % transparency, white/matt - 75 % transparency or black matt - 25 % transparency) are made from shatterproof, flame-retardant polycarbonate (classification flammability UL94 V-2) and create homogeneous LED lighting conditions with high utilisation of the light output.

Covers also available in 6 m length!

Due to the small dimensions and low weight, this LED profile is ideally suited as a LED light source in residential and office furniture, home accessories, display cases, shelves and stairs and of course on walls and ceiling.

Das PK1 LED AUFBAU-Profil hat ein besonders schmales und flaches Design, ist für LED Flexbänder mit einer maximalen Breite von 12 mm konzipiert. Dieses Alu-Profil kann auch anwendungsspezifisch zum Einbau verwendet werden.

Die LED Profilabdeckungen Opal/satiniert (Lichtdurchlässigkeit 65 %), Klar (Lichtdurchlässigkeit 85 %), weiß/matt (Lichtdurchlässigkeit 75 %) oder Schwarz Matt (Lichtdurchlässigkeit 25 %) bestehen aus bruchsicherem und schwer brennbarem Polycarbonat (Klassifizierung Brennbarkeit UL94 V-2) und schaffen homogene LED Lichtverhältnisse mit hoher Verwertung der Lichtleistung.

Abdeckungen auch in 6 m verfügbar!

Aufgrund der kleinen Abmessungen und des geringen Gewichtes sind diese LED Profile unter anderem als ideale LED Lichtquelle in Wohn- und Büromöbeln, Wohnaccessoires, Vitrinen, Regalen sowie an Treppenstufen und selbstverständlich an Wänden und Decken geeignet.

GALAXY profiles
Perfect Light Lines



PK1 + C1

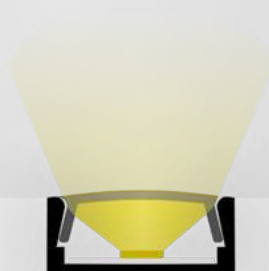

PK1 + C32

max.
12 mm

OEM

GALAXY profiles
Perfect Light Lines

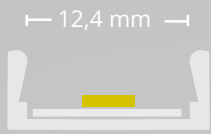

COVERS | ABDECKUNGEN

C1 65 %	200cm 8600004	250 cm 8600026	300 cm 8600080	600 cm 8600037
C2 85 %	200 cm 8600003	250 cm 8600135	300 cm 8600136	
C58 75 %	200 cm 8600154			
C32 25 %	200 cm 8600070	300 cm 8600103	600 cm 8600071	

END CAPS | ENDKAPPEN

E223	E223 anthrazit 8305019	E223 8305023	E223 8305021
E224	E224 anthrazit 8305020	E224 8305024	E224 8305022

PROFILE

PK1	200 cm 8201025	200 cm 8201027	200cm 8201026
	Z39 8123328		

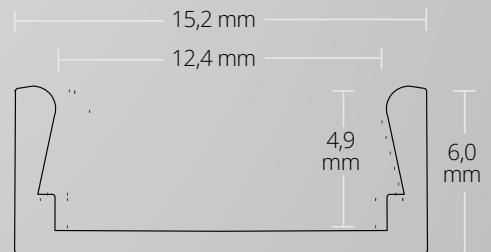

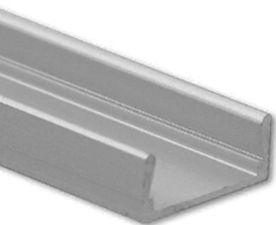

PK1 SURFACE | AUFBAU

flat | flach | LED Strips max. 12 mm
15,2 mm x 6,0 mm | 81 g/m

200 cm **8201025** 200 cm **8201027** 200 cm **8201026**



Z39

Mounting Clips
Montageklammer
Sheet steel | Stahlblech
8123328

max.
12 mm

OEM

COVERS | ABDECKUNGEN



C1 opal | opal | 65 %

PC | 13,8 mm x 4,4 mm

200cm **8600004** 250cm **8600026** 300cm **8600080** 600cm **8600037**



C2 clear | klar | 85 %

PC | 13,8 mm x 4,4 mm

200cm **8600003** 250cm **8600135** 300cm **8600136**



C58 white/matt | weiß/matt | 75 %

PC | 13,8 mm x 4,4 mm

200cm **8600154**



C32 black/matt | schwarz/matt | 25 %

PC | 13,8 mm x 4,4 mm

200cm **8600070** 300cm **8600103** 600cm **8600071**

END CAPS | ENDKAPPEN



E223 NYLON | 1 PCS/STK

E223 | anthrazit **8305019** E223 **8305023** E223 **8305021**



E224 NYLON | 1 PCS/STK | Cable/Kabel

E224 | anthrazit **8305020** E224 **8305024** E224 **8305022**

PK2

SURFACE | AUFBAU

200 cm

max. 12 mm

OEM

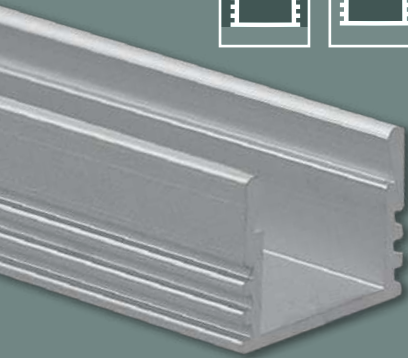

EXTENSION OF SERVICE LIFE
VERLÄNGERUNG LEBENSDAUER

MECHANICAL PROTECTION
MECHANISCHER SCHUTZ

COOLING
KÜHLUNG

HIGH LIGHT UTILISATION
HOHE LICHTVERWERTUNG

HOMOGENEOUS LIGHT
HOMOGENES LICHT

HOMOGENEOUS LIGHT with modular LED light solutions

- Wall, ceiling or floor mounting
Wand-, Decken- oder Bodenmontage
- Residential and office furniture
Wohn- und Büromöbel
- Furniture for business equipment
Möbel für Geschäftsausstattung
- Home accessories
Wohnaccessoires
- Mirrors | Spiegel
- Cabinet doors | Schranktüren
- Display cases | Vitrinen
- Shelves | Regale
- Stairs and railings
Treppenstufen und -Geländer
- Balustrades | Balustraden
- Façades, balconies and terraces
Fassaden, Balkone und Terrassen
- Living spaces | Wohnräume
- Offices | Büroräume
- Hotel and gastronomy business
Hotellerie und Gastronomie
- Retail (shop and showcase windows)
Einzelhandel (Shop- und Schaufenster)
- Business areas and showrooms
Geschäftsflächen und Showrooms
- Barber / Beauty / body art studios
Friseur-/Beauty-/Body-Art-Studios
- Halls, foyers and corridors
Hallen, Foyers und Flure
- Wellness and indoor leisure facilities
Wellness- und Indoor-Freizeitanlagen
- Wet rooms | Nasszellen

Mounting/installation on/in wood Strips and plates, plasterboard, tiles, stone, granite, marble and metal surfaces
Montage/Einbau auf/in Holzleisten und -platten, Gipsplatten, Fliesen, Stein-, Granit-, Marmor- und Metalloberflächen



PK2

SURFACE | AUFBAU

high | hoch | LED Strips max. 12 mm

Silver/Silber
ANODIZED | ELOXIERT

RAL 9010 White/Weiß
POWDER-COATED | PULVERBESCHICHTET

RAL 9005 Black/Schwarz
POWDER-COATED | PULVERBESCHICHTET

max.
12 mm



OEM



max. 12 mm

The PK2 LED SURFACE profile has a particularly narrow design. It is designed for LED flex strips with a maximum width of 12 mm. This aluminium profile can also be used for recessed installation.

The profile covers (opal/satinised - 65 % transparency clear - 85 % transparency, white/matt - 75 % transparency or black matt - 25 % transparency) are made from shatterproof, flame-retardant polycarbonate (classification flammability UL94 V-2) and create homogeneous LED lighting conditions with high utilisation of the light output.

Covers available in 6m length!

This LED profile offers higher cooling effects as PK1 LED SURFACE Profile. This effect comes with the greater interior height. Therefore, more powerful LED flex strips can be integrated without sacrifice to homogeneous LED light lines (no pinpoints of light but rather continuous lines of light). Due to the small dimensions and low weight, this LED profile is ideally suited as a LED light source in residential and office furniture, home accessories, display cases, shelves and stairs and of course on walls and ceiling.

Das PK2 LED AUFBAU-Profil hat ein besonders schmales Design, ist für LED Flexbänder mit einer maximalen Breite von 12 mm konzipiert. Dieses Alu-Profil kann auch anwendungsspezifisch zum Einbau verwendet werden.

Die LED Profilabdeckungen Opal/satiniert (Lichtdurchlässigkeit 65 %), Klar (Lichtdurchlässigkeit 85 %), weiß/matt (Lichtdurchlässigkeit 75 %) oder Schwarz Matt (Lichtdurchlässigkeit 25 %) bestehen aus bruchsicherem und schwer brennbarem Polycarbonat (Klassifizierung Brennbarkeit UL94 V-2) und schaffen homogene LED Lichtverhältnisse mit hoher Verwertung der Lichtleistung.

Abdeckungen auch in 6 m verfügbar!

Dieses LED Profil hat aufgrund seiner im Vergleich zum PK1 LED AUFBAU-Profil größeren Innenhöhe auch einen größeren Kühlkörper und kann somit mit stärkeren LED Flexbändern bestückt werden, ohne dabei auf homogene LED Lichtlinien verzichten zu müssen (keine Lichtpunkte, sondern durchgängige Lichtlinie). Wegen der kleinen Abmessungen und des geringen Gewichtes ist dieses Profilsystem unter anderem als ideale LED Lichtquelle in Wohn- und Büromöbeln, Wohnaccessoires, Vitrinen, Regalen sowie an Treppenstufen und selbstverständlich an Wänden und Decken geeignet.

GALAXY profiles
Perfect Light Lines



PK2+ C1

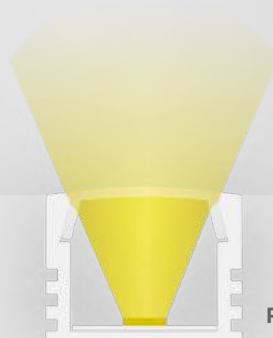

PK2 + C58

max.
12 mm

GALAXY profiles
Perfect Light Lines

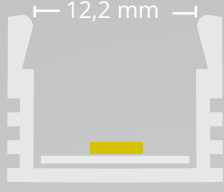

OEM



COVERS | ABDECKUNGEN

C1 65 %	200cm 8600004	250 cm 8600026	300 cm 8600080	600 cm 8600037
C2 85 %	200 cm 8600003	250 cm 8600135	300 cm 8600136	
C58 75 %	200 cm 8600154			
C32 25 %	200 cm 8600070	300 cm 8600103	600 cm 8600071	

END CAPS | ENDKAPPEN

E225	E225 anthrazit 8305025	E225 830509	E225 8305027
E226	E226 anthrazit 8305026	E226 8305030	E226 8305028

PROFILE

PK2	200 cm 8201028	200 cm 8201030	200cm 8201029
	Z39 8123328		

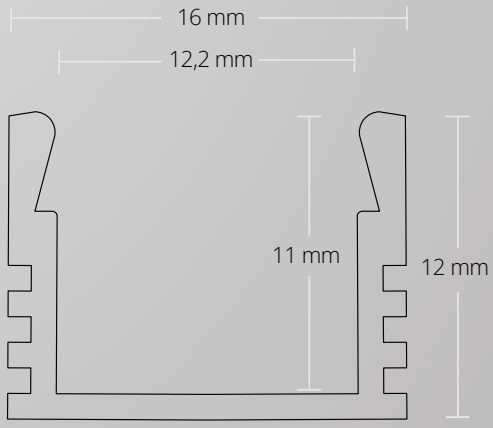



PK2 SURFACE | AUFBAU

high | hoch | LED Strips max. 12 mm
16,0 mm x 12,0 mm | 142 g/m

200 cm **8201028** 200 cm **8201030** 200 cm **8201029**



Z39
Mounting Clips
Montageklammer
Sheet steel | Stahlblech
8123328

max.
12 mm



OEM

COVERS | ABDECKUNGEN

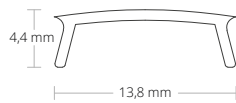

C1 opal | opal | 65 %

PC | 13,8 mm x 4,4 mm

200cm **8600004** 250cm **8600026** 300cm **8600080** 600cm **8600037**



C2 clear | klar | 85 %

PC | 13,8 mm x 4,4 mm

200cm **8600003** 250cm **8600135** 300cm **8600136**

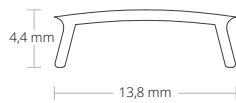

C58 white/matt | weiß/matt | 75 %

PC | 13,8 mm x 4,4 mm

200cm **8600154**



C32 black/matt | schwarz/matt | 25 %

PC | 13,8 mm x 4,4 mm

200cm **8600070** 300cm **8600103** 600cm **8600071**

END CAPS | ENDKAPPEN



E225 NYLON | 1 PCS/STK

E225 | anthrazit **8305025** E223 **8305029** E223 **8305027**



E226 NYLON | 1 PCS/STK | Cable/Kabel

E226 | anthrazit **8305026** E226 **8305030** E226 **8305028**

PK3

RECESSED | EINBAU

200 cm

max. 12 mm

OEM

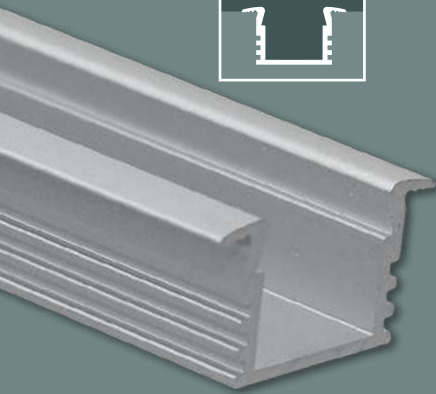

EXTENSION OF SERVICE LIFE
VERLÄNGERUNG LEBENSDAUER

MECHANICAL PROTECTION
MECHANISCHER SCHUTZ

COOLING
KÜHLUNG

HIGH LIGHT UTILISATION
HOHE LICHTVERWERTUNG

HOMOGENEOUS LIGHT
HOMOGENES LICHT

HOMOGENEOUS LIGHT with modular LED light solutions

- Wall, ceiling or floor mounting
Wand-, Decken- oder Bodenmontage
- Residential and office furniture
Wohn- und Büromöbel
- Furniture for business equipment
Möbel für Geschäftsausstattung
- Home accessories
Wohnaccessoires
- Cabinet doors | Schranktüren
- Display cases | Vitrinen
- Shelves | Regale
- Wet rooms | Nasszellen
- Stairs and railings
Treppenstufen und -Geländer
- Balustrades | Balustraden
- Façades, balconies and terraces
Fassaden, Balkone und Terrassen
- Living spaces | Wohnräume
- Offices | Büroräume
- Hotel and gastronomy business
Hotellerie und Gastronomie
- Retail (shop and showcase windows)
Einzelhandel (Shop- und Schaufenster)
- Business areas and showrooms
Geschäftsflächen und Showrooms
- Barber / Beauty / body art studios
Friseur-/Beauty-/Body-Art-Studios
- Halls, foyers and corridors
Hallen, Foyers und Flure
- Wellness and indoor leisure facilities
Wellness- und Indoor-Freizeitanlagen

Mounting/installation on/in wood Strips and plates, plasterboard, tiles, stone, granite, marble and metal surfaces
Montage/Einbau auf/in Holzleisten und -platten, Gipsplatten, Fliesen, Stein-, Granit-, Marmor- und Metalloberflächen



PK3

RECESSED | EINBAU

high/wings | hoch/Flügel | LED Strips max. 12 mm

Silver/Silber
ANODIZED | ELOXIERT



max. 12 mm

max.
12 mm



OEM

PK3 LED RECESSED Profile has a particularly narrow design, is designed for LED flex strips with a maximum width of 12 mm and is universally used in interior areas.

The profile covers (opal/satinised - 65 % transparency clear - 85 % transparency, white/matt - 75 % transparency or black matt - 25 % transparency) are made of shatter-proof, flame-retardant polycarbonate (classification flammability UL94 V-2) and create homogeneous LED lighting conditions with high utilisation of the light output (no pinpoint of light, but rather continuous line of light).

Covers available in 6m length!

These LED RECESSED Profiles are barely visible inserted/sunk in walls and ceilings with plaster, stone or concrete panels as well as wood panelling due to their small dimensions and low weight. They can be installed in pre-milled furniture. They are thus ideal LED light sources in residential and office furniture, home accessories, display cases, shelves, stairs and, of course, on walls and ceilings.

Das PK3 LED EINBAU-Profil hat ein besonders schmales Design, ist für LED Flexbänder mit einer maximalen Breite von 12 mm konzipiert und wird universell im Innenbereich eingesetzt.

Die LED Profilabdeckungen Opal/satiniert (Lichtdurchlässigkeit 65 %), Klar (Lichtdurchlässigkeit 85 %), weiß/matt (Lichtdurchlässigkeit 75 %) oder Schwarz Matt (Lichtdurchlässigkeit 25 %) bestehen aus bruchsicherem und schwer brennbarem Polycarbonat (Klassifizierung Brennbarkeit UL94 V-2) und schaffen homogene LED Lichtverhältnisse mit hoher Verwertung der Lichtleistung (keine Lichtpunkte, sondern durchgängige Lichtlinie).

Abdeckungen auch in 6 m verfügbar!

Diese LED EINBAU-Profile werden aufgrund ihrer kleinen Abmessungen und des geringen Gewichtes in Wänden und Decken mit Gips-, Stein- oder Betonplatten sowie Holzverkleidungen kaum sichtbar versenkt. Sie können auch in vorgefräste Möbel installiert werden. Sie sind somit ideale LED Lichtquellen in Wohn- und Büromöbeln, Wohnaccessoires, Vitrinen, Regalen, an Treppenstufen und selbstverständlich an Wänden und Decken.

GALAXY profiles
Perfect Light Lines

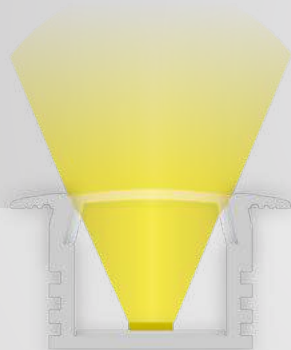

PK3 + C1

max.
12 mm

GALAXY profiles
Perfect Light Lines

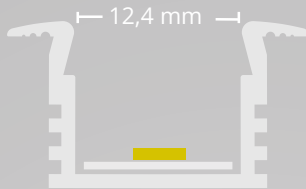

OEM

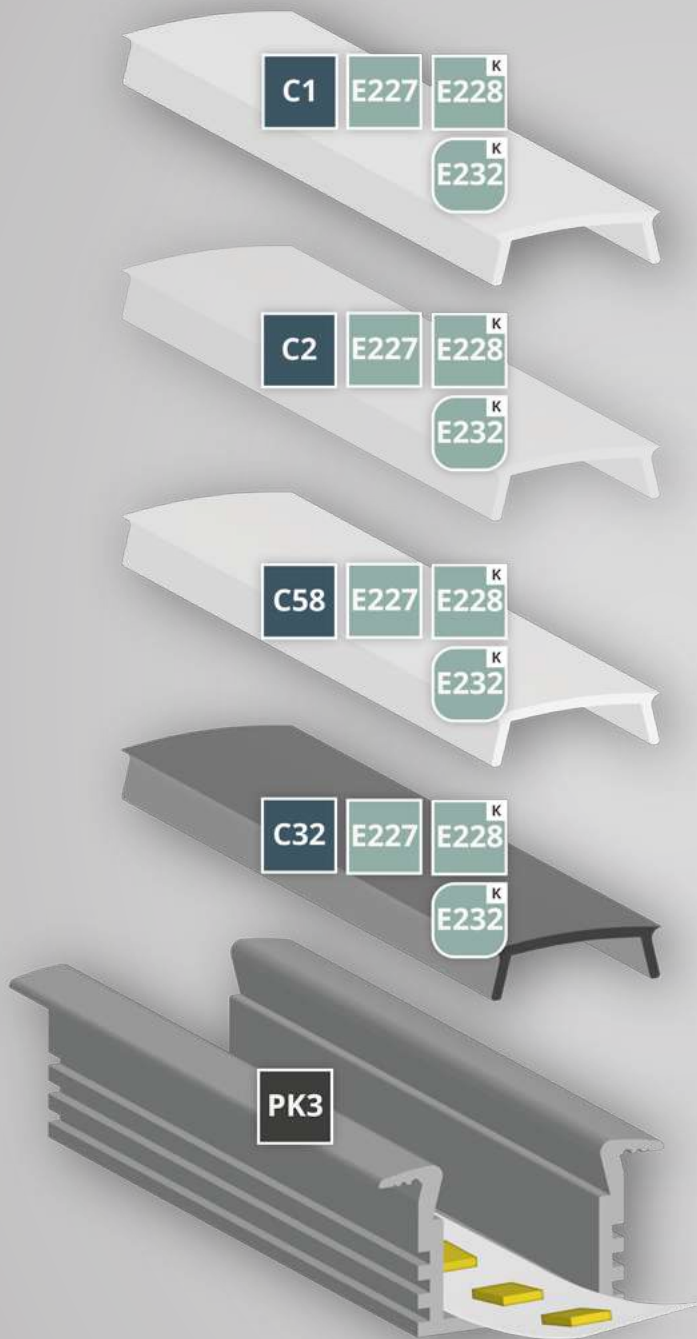

COVERS | ABDECKUNGEN

C1 65 %	200cm 8600004	250 cm 8600026	300 cm 8600080	600 cm 8600037
C2 85 %	200 cm 8600003	250 cm 8600135	300 cm 8600136	
C58 75 %	200 cm 8600154			
C32 25 %	200 cm 8600070	300 cm 8600103	600 cm 8600071	

END CAPS | ENDKAPPEN

- E227** E227 | anthrazit
8305031
- E228** E228 | anthrazit
8305033
- E232** E232 | anthrazit
8305035

PROFILE

- PK3** 200 cm
8201032
- Z39**
8123328

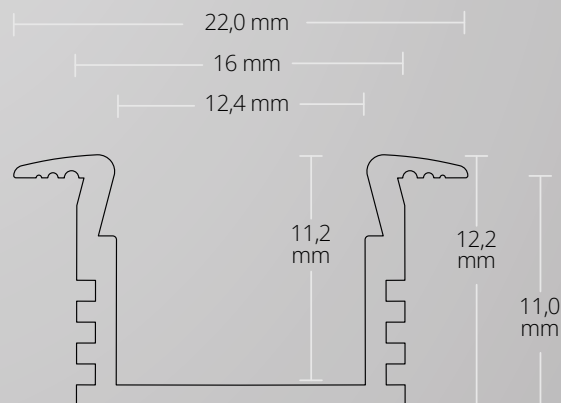



PK3 RECESSED | EINBAU

high/wings | hoch/Flügel | LED Strips max. 12 mm
22,0 mm x 12,2 mm | 154 g/m

200 cm
8201032

max.
12 mm

OEM



Z39
Mounting Clips
Montageklammer
Sheet steel | Stahlblech
8123328



COVERS | ABDECKUNGEN



C1 opal | opal | 65 %
PC | 13,8 mm x 4,4 mm
200cm **8600004** 250cm **8600026** 300cm **8600080** 600cm **8600037**



C2 clear | klar | 85 %
PC | 13,8 mm x 4,4 mm
200cm **8600003** 250cm **8600135** 300cm **8600136**

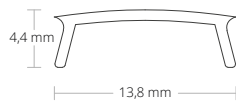

C58 white/matt | weiß/matt | 75 %
PC | 13,8 mm x 4,4 mm
200cm **8600154**

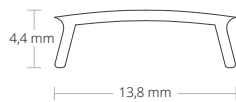

C32 black/matt | schwarz/matt | 25 %
PC | 13,81 mm x 4,4 mm
200cm **8600070** 300cm **8600103** 600cm **8600071**

END CAPS | ENDKAPPEN



E227 NYLON | 1 PCS/STK
E227 | anthrazit
8305031



E228 NYLON | 1 PCS/STK | Cable/Kabel
E228 | anthrazit
8305033



E232 NYLON | ROUND/RUND | 1 PCS/STK
E232 | anthrazit
8305035

PK8

RECESSED | EINBAU

200 cm

max. 12 mm

OEM

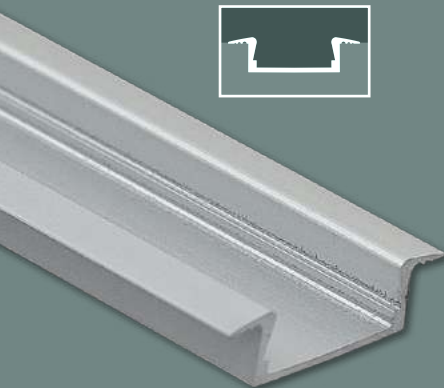

EXTENSION OF SERVICE LIFE
VERLÄNGERUNG LEBENSDAUER

MECHANICAL PROTECTION
MECHANISCHER SCHUTZ

COOLING
KÜHLUNG

HIGH LIGHT UTILISATION
HOHE LICHTVERWERTUNG

HOMOGENEOUS LIGHT
HOMOGENES LICHT

HOMOGENEOUS LIGHT with modular LED light solutions

- Wall, ceiling or floor mounting
Wand-, Decken- oder Bodenmontage
- Residential and office furniture
Wohn- und Büromöbel
- Furniture for business equipment
Möbel für Geschäftsausstattung
- Home accessories
Wohnaccessoires
- Cabinet doors | Schranktüren
- Display cases | Vitrinen
- Shelves | Regale
- Stairs and railings
Treppenstufen und -Geländer
- Balustrades | Balustraden
- Façades, balconies and terraces
Fassaden, Balkone und Terrassen
- Living spaces | Wohnräume
- Offices | Büroräume
- Hotel and gastronomy business
Hotellerie und Gastronomie
- Retail (shop and showcase windows)
Einzelhandel (Shop- und Schaufenster)
- Business areas and showrooms
Geschäftsflächen und Showrooms
- Barber / Beauty / body art studios
Friseur-/Beauty-/Body-Art-Studios
- Halls, foyers and corridors
Hallen, Foyers und Flure
- Wellness and indoor leisure facilities
Wellness- und Indoor-Freizeitanlagen
- Wet rooms | Nasszellen

Mounting/installation on/in wood Strips and plates, plasterboard, tiles, stone, granite, marble and metal surfaces
Montage/Einbau auf/in Holzleisten und -platten, Gipsplatten, Fliesen, Stein-, Granit-, Marmor- und Metalloberflächen



PK8

RECESSED | EINBAU

flat/wings | flach/Flügel | LED Strips max. 12 mm

Silver/Silber
ANODIZED | ELOXIERT



max. 12 mm

max.
12 mm



OEM

PK8 LED RECESSED Profile has a particularly narrow design, is designed for LED flex strips with a maximum width of 12 mm and is universally used in interior areas.

The profile covers (opal/satinised - 65 % transparency clear - 85 % transparency, white/matt - 75 % transparency or black matt - 25 % transparency) are made of shatter-proof, flame-retardant polycarbonate (classification flammability UL94 V-2) and create homogeneous LED lighting conditions with high utilisation of the light output (no pinpoint of light, but rather continuous line of light).

Covers available in 6m length!

These LED RECESSED Profiles are barely visible inserted/sunk in walls and ceilings with plaster, stone or concrete panels as well as wood panelling due to their small dimensions and low weight. They can be installed in pre-milled furniture. They are thus ideal LED light sources in residential and office furniture, home accessories, display cases, shelves, stairs and, of course, on walls and ceilings.

Das PK8 LED EINBAU-Profil hat ein besonders schmales Design, ist für LED Flexbänder mit einer maximalen Breite von 12 mm konzipiert und wird universell im Innenbereich eingesetzt.

Die LED Profilabdeckungen Opal/satiniert (Lichtdurchlässigkeit 65 %), Klar (Lichtdurchlässigkeit 85 %), weiß/matt (Lichtdurchlässigkeit 75 %) oder Schwarz Matt (Lichtdurchlässigkeit 25 %) bestehen aus bruchsicherem und schwer brennbarem Polycarbonat (Klassifizierung Brennbarkeit UL94 V-2) und schaffen homogene LED Lichtverhältnisse mit hoher Verwertung der Lichtleistung.

Abdeckungen auch in 6 m verfügbar!

Diese LED EINBAU-Profile werden aufgrund ihrer kleinen Abmessungen und des geringen Gewichtes in Wänden und Decken mit Gips-, Stein- oder Betonplatten sowie Holzverkleidungen kaum sichtbar versenkt. Sie können auch in vorgefräste Möbel installiert werden. Sie sind somit ideale LED Lichtquellen in Wohn- und Büromöbeln, Wohnaccessoires, Vitrinen, Regalen, an Treppenstufen und selbstverständlich an Wänden und Decken.

GALAXY profiles
Perfect Light Lines



PK8 + C1

max.
12 mm

OEM

GALAXY profiles
Perfect Light Lines

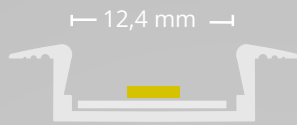

COVERS | ABDECKUNGEN

C1 65 %	200cm 8600004	250 cm 8600026	300 cm 8600080	600 cm 8600037
C2 85 %	200 cm 8600003	250 cm 8600135	300 cm 8600136	
C58 75 %	200 cm 8600154			
C32 25 %	200 cm 8600070	300 cm 8600103	600 cm 8600071	

END CAPS | ENDKAPPEN

E229	E229 anthrazit 8305034
E230	E230 anthrazit 8305032
E231	E231 anthrazit 8305036

PROFILE

PK8	200 cm 8201031
	Z39 8123328

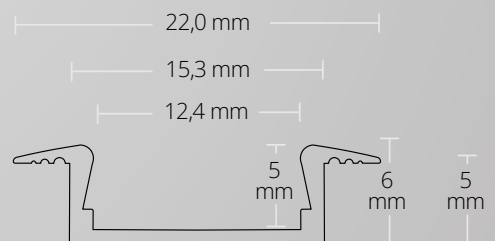



PK8 RECESSED | EINBAU

flat/wings | flach/Flügel | LED Strips max. 12 mm
22,0 mm x 6,0 mm | 87 g/m

200 cm
8201031

max.
12 mm

OEM



Z39
Mounting Clips
Montageklammer
Sheet steel | Stahlblech
8123328

COVERS | ABDECKUNGEN

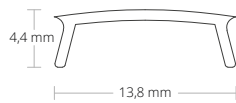

C1 opal | opal | 65 %
PC | 13,8 mm x 4,4 mm
200cm 250cm 300cm 600cm
8600004 8600026 8600080 8600037



C2 clear | klar | 85 %
PC | 13,8 mm x 4,4 mm
200cm 250cm 300cm
8600003 8600135 8600136



C58 white/matt | weiß/matt | 75 %
PC | 13,8 mm x 4,4 mm
200cm
8600154



C32 black/matt | schwarz/matt | 25 %
PC | 13,8 mm x 4,4 mm
200cm 300cm 600cm
8600070 8600103 8600071

END CAPS | ENDKAPPEN



E229 NYLON | 1 PCS/STK
E229 | anthrazit
8305034



E230 NYLON | 1 PCS/STK | Cable/Kabel
E230 | anthrazit
8305032



E231 NYLON | ROUND/RUND | 1 PCS/STK
E231 | anthrazit
8305036

VP1

CURTAIN | GARDINEN

100 cm | 200 cm

max. 10 mm

OEM

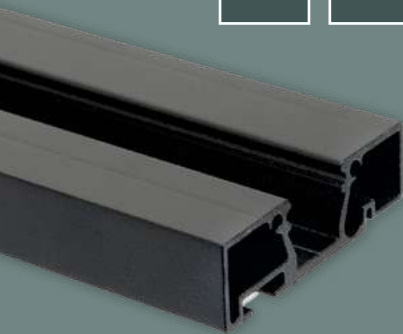

NEW TO OUR RANGE
IM SORTIMENT

EXTENSION OF SERVICE LIFE
VERLÄNGERUNG LEBENSDAUER

MECHANICAL PROTECTION
MECHANISCHER SCHUTZ

COOLING
KÜHLUNG

HIGH LIGHT UTILISATION
HOHE LICHTVERWERTUNG

HOMOGENEOUS LIGHT
HOMOGENES LICHT

HOMOGENEOUS LIGHT with modular LED light solutions

- Ceiling mounting
Deckenmontage
- Home accessories
Wohnaccessoires
- Cabinet doors | Schranktüren
- Living spaces | Wohnräume
- Offices | Büroräume
- Hotel and gastronomy business
Hotellerie und Gastronomie
- Retail (shop and showcase windows)
Einzelhandel (Shop- und Schaufenster)
- Business areas and showrooms
Geschäftsflächen und Showrooms
- Barber / Beauty / body art studios
Friseur-/Beauty-/Body-Art-Studios
- Halls, foyers and corridors
Hallen, Foyers und Flure
- Wellness and indoor leisure facilities
Wellness- und Indoor-Freizeitanlagen
- Medical practice | Arztpraxis
- School | Schule
- Theatre & exhibition spaces
Theater & Ausstellungsflächen
- Museums | Museen

Mounting/installation on/in wood Strips and plates, plasterboard, tiles, stone, granite, marble and metal surfaces
Montage/Einbau auf/in Holzleisten und -platten, Gipsplatten, Fliesen, Stein-, Granit-, Marmor- und Metalloberflächen



VP1

CURTAIN | GARDINEN

Single | Einbahnig | LED Strips max. 10 mm

RAL 9010 White/Weiß
 POWDER-COATED | PULVERBESCHICHTET

RAL 9005 Black/Schwarz
 POWDER-COATED | PULVERBESCHICHTET



max. 10 mm

The VP1 LED curtain profile is designed for LED flex stripe up to 10 mm wide and can be used universally in interior applications. It can be fitted with a flex strip or – in combination with our PC inlays – also used as a curtain rail. This allows lighting to be discreetly integrated into the interior design.

The high-quality aluminium profile impresses with its elegant appearance, functionality and effective heat dissipation, especially when the flex strip is used underneath the curtain. Flex strip, curtains or a combination of both can be used flexibly in the profile.

The profile covers made of break-proof, flame-retardant polycarbonate (UL94 V-2) are available in opal/satin (65% light transmission), black/matt (25%) and clear (85%). They ensure homogeneous lighting conditions and high utilisation of light output.

The VP1 is ideal for living spaces, offices or hotels – anywhere where unobtrusive but effective lighting is required. With matching accessories such as end caps, covers or curtain panels, a harmonious overall appearance can be achieved.

* Classification flammability UL94 V-2: Extinguishing of a vertically clamped sample within 30 seconds

Das VP1 LED Gardinenprofil ist für LED-Flexbänder bis 10 mm Breite konzipiert und universell im Innenbereich einsetzbar. Es kann mit einem Flexband bestückt oder – in Kombination mit unseren PC-Inlays – auch als Vorhangsschiene genutzt werden. So lässt sich Beleuchtung dezent in die Raumgestaltung integrieren.

Das hochwertige Aluminiumprofil überzeugt durch elegante Optik, Funktionalität und effektive Wärmeableitung, besonders wenn das Flexband unterhalb des Vorhangs eingesetzt wird. Flexband, Vorhang oder eine Kombination aus beidem können flexibel im Profil verwendet werden.

Die Profilabdeckungen aus bruchsicherem, schwer entflammarem Polycarbonat (UL94 V-2) sind in Opal/satiniert (65 % Lichtdurchlässigkeit), Schwarz/matt (25 %) und Klar (85 %) erhältlich. Sie sorgen für homogene Lichtverhältnisse und eine hohe Ausnutzung der Lichtleistung.

Das VP1 eignet sich ideal für Wohnräume, Büros oder Hotels – überall dort, wo unauffällige, aber wirkungsvolle Beleuchtung gefragt ist. Mit passendem Zubehör wie Endkappen, Abdeckungen oder Vorhangblenden lässt sich ein harmonisches Gesamtbild erzielen.

*Klassifizierung Brennbarkeit UL94 V-2: Verlöschen einer vertikal eingespannten Probe innerhalb von 30 Sekunden

GALAXY profiles
Perfect Light Lines



VP1 + C1



VP1 + C1 + VP4 + C32



VP1 + CV1+ Z66 + VP4 + C1

max.
10 mm

GALAXY profiles
Perfect Light Lines

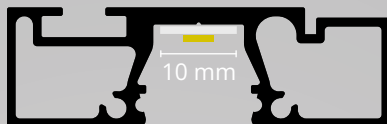

OEM

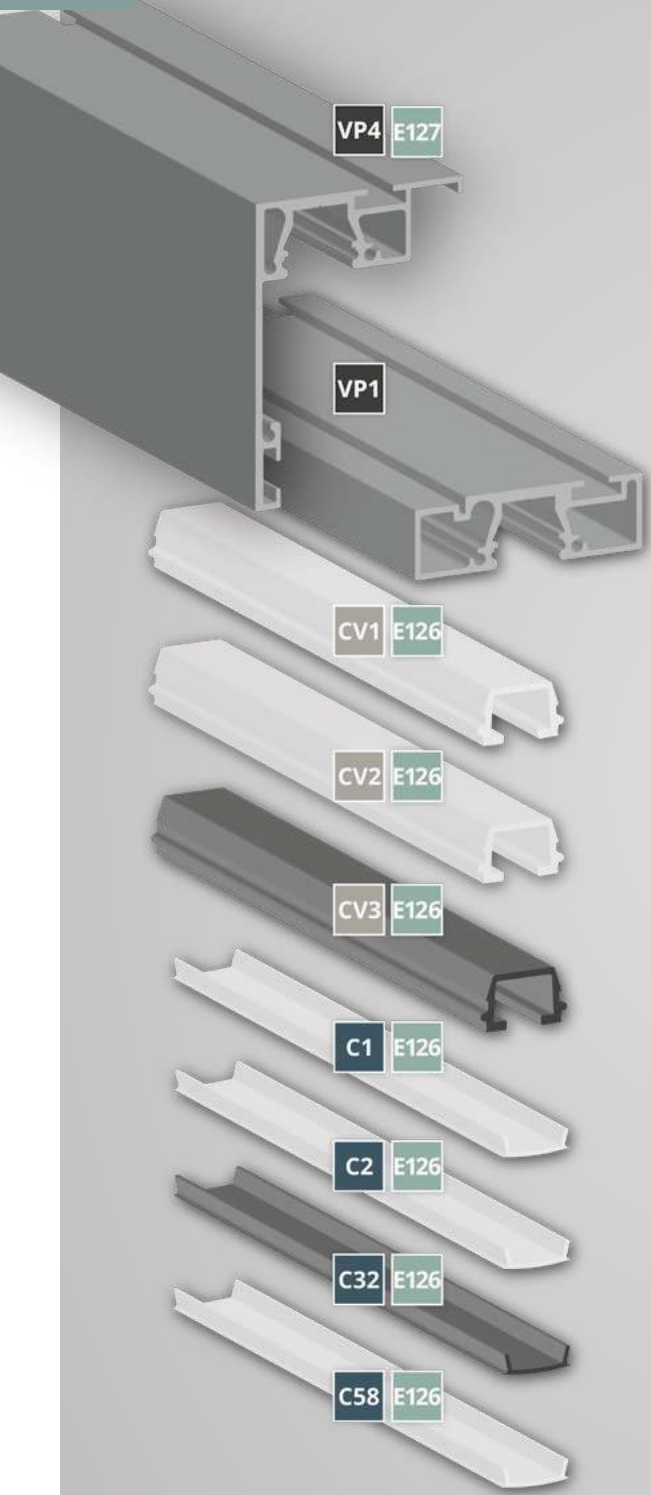

PC-INLAYS

CV1 65 %	100cm 8123581	200 cm 8123550
CV2 85 %	100 cm 8123582	200 cm 8123551
CV3 25 %	100 cm 8123593	200 cm 8123592

COVERS | ABDECKUNGEN

C1 65 %	200cm 8600004	250 cm 8600026	300 cm 8600080	600 cm 8600037
C2 85 %	200 cm 8600003	250 cm 8600135	300 cm 8600136	
C58 75 %	200 cm 8600154			
C32 25 %	200 cm 8600070	300 cm 8600103	600 cm 8600071	

END CAPS | ENDKAPPEN

E126	E126W 8192328	E126B 8192327
E127	E127W 8192316	E127B 8192315

PROFILE

VP1	200 cm 8123539	200 cm 8123538			
VP4	200 cm 8123543	200 cm 8123542			
	Z25 8301513				
	Z66 100 pcs./stk. 8192335				
Z67	2 pcs./stk. 8192332	2 pcs./stk. 8192331	Z68	2 pcs./stk. 8192334	2 pcs./stk. 8192333
Z72	opal opal 8192336	clear klar 8123610	black schwarz 8192337	Z73	8123552

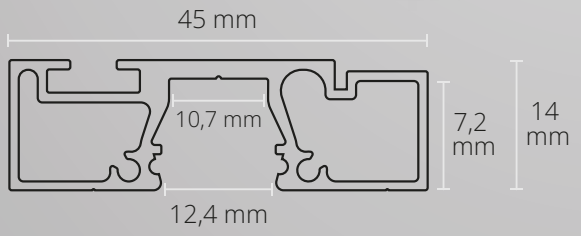

388

INSTALLATION INSTRUCTION
INSTALLATIONS MONTAGE



VP1 CURTAIN | GARDINEN NEW

Single | Einbahrig | LED Strips max. 10 mm

45 mm x 14 mm | 480 g/m

□ 200 cm
8123539

■ 200 cm
8123538



VP4 NEW

Curtain visor, 200 cm
Gardinenblende, 200 cm

□ **8123543**

■ **8123542**

max.
10 mm



OEM

Z66 NEW

Roller glider for PC-Inlay | 100 pcs.
Rollengleiter für PC-Inlay | 100 stk.

8192335



Z67 NEW

Wall fitting, short | 2 pcs.
Wandbeschlag, kurz | 2 stk.

□ **8192332**

■ **8192331**



Z68 NEW

Wall fitting, long | 2 pcs.
Wandbeschlag, lang | 2 stk.

□ **8192334**

■ **8192333**



Z25

Connector | Verbinder
Steel | Stahl | 4 PCS/STK

□ 180°
8301513



Z72 NEW

Curtain insertion aid
Vorhangschleuse

opal | opal **8192336**

clear | klar **8123610**

black | schwarz **8192337**



Z73 NEW

Lock for curtain track
Feststeller für Vorhanglauf

8123552



COVERS | ABDECKUNGEN

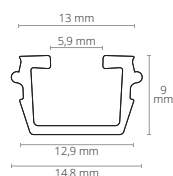
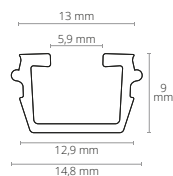
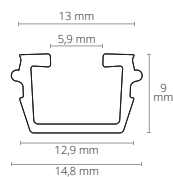
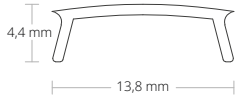

C1 opal/satinised | opal/satiniert | 65 %

PC | 13,81 mm x 4,37 mm

200cm
8600004

250cm
8600026

600cm
8600037

C2 transparent | klar | 85 %

PC | 13,81 mm x 4,37 mm

200cm
8600003

250cm
8600135

300cm
8600136

C32 black/matt | schwarz/matt | 25 %

PC | 13,81 mm x 4,37 mm

200cm
8600070

600cm
8600071

C58 white/matt | weiß/matt | 75 %

PC | 13,8 mm x 4,4 mm

200cm
8600154

CV1 opal/satinised | opal/satiniert | 65 % NEW

PC | 14,8 mm x 9 mm

100cm
8123581

200cm
8123550

CV2 clear | klar | 85 % NEW

PC | 14,8 mm x 9 mm

100cm
8123582

200cm
8123551

CV3 black/matt | schwarz/matt | 25 % NEW

PC | 14,8 mm x 9 mm

100cm
8123593

200cm
8123592

END CAPS | ENDKAPPEN



E126 PVC | 1 PCS/STK NEW

□ E126W
8192328

■ E126B
8192327



E127 PVC | 1 PCS/STK | for VP4 | für VP4 NEW

□ E127W
8192316

■ E127B
8192315

VP2

CURTAIN | GARDINEN

100 cm | 200 cm

max. 10 mm

OEM

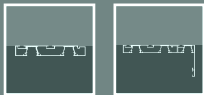

NEW TO OUR RANGE
IM SORTIMENT

EXTENSION OF SERVICE LIFE
VERLÄNGERUNG LEBENSDAUER

MECHANICAL PROTECTION
MECHANISCHER SCHUTZ

COOLING
KÜHLUNG

HIGH LIGHT UTILISATION
HOHE LICHTVERWERTUNG

HOMOGENEOUS LIGHT
HOMOGENES LICHT

HOMOGENEOUS LIGHT with modular LED light solutions

- Ceiling mounting
Deckenmontage
- Home accessories
Wohnaccessoires
- Cabinet doors | Schranktüren
- Living spaces | Wohnräume
- Offices | Büroräume
- Hotel and gastronomy business
Hotellerie und Gastronomie
- Retail (shop and showcase windows)
Einzelhandel (Shop- und Schaufenster)
- Business areas and showrooms
Geschäftsflächen und Showrooms
- Barber / Beauty / body art studios
Friseur-/Beauty-/Body-Art-Studios
- Halls, foyers and corridors
Hallen, Foyers und Flure
- Wellness and indoor leisure facilities
Wellness- und Indoor-Freizeitanlagen
- Medical practice | Arztpraxis
- School | Schule
- Theatre & exhibition spaces
Theater & Ausstellungsflächen
- Museums | Museen

Mounting/installation on/in wood Strips and plates, plasterboard, tiles, stone, granite, marble and metal surfaces
Montage/Einbau auf/in Holzleisten und -platten, Gipsplatten, Fliesen, Stein-, Granit-, Marmor- und Metalloberflächen



VP2

CURTAIN | GARDINEN

Double | Zweibahnig | LED Strips max. 10 mm

RAL 9010 White/Weiß
 POWDER-COATED | PULVERBESCHICHTET

RAL 9005 Black/Schwarz
 POWDER-COATED | PULVERBESCHICHTET



max. 10 mm

The VP2 LED curtain profile is designed for LED flex strips up to 10 mm wide and is versatile for indoor use. With its two channels, it can be fitted with flex strips or used as a curtain rail in combination with PC inlays. This allows lighting to be discreetly integrated into the curtain concept.

The aluminium profile impresses with its elegant appearance, functionality and reliable heat dissipation, especially when the flexible strip is used underneath the curtain. Flexible tape, curtains or both can be combined flexibly.

The VP2 is ideal for living spaces, restaurants or showrooms – anywhere where discreet yet effective lighting is required. Accessories such as end caps, covers or curtain panels create a harmonious overall look.

The profile covers made of shatterproof, flame-retardant polycarbonate (UL94 V-2) are available in opal/satin (65%), black/matt (25%) and clear (85%). They ensure homogeneous lighting conditions and high light output.

* Classification flammability UL94 V-2: Extinguishing of a vertically clamped sample within 30 seconds

Das VP2 LED Gardinenprofil ist für LED-Flexbänder bis 10 mm Breite ausgelegt und vielseitig im Innenbereich einsetzbar. Mit seinen zwei Kanälen kann es sowohl mit Flexband bestückt als auch – in Kombination mit PC-Inlays – als Vorhangschiene genutzt werden. So lässt sich Beleuchtung dezent in das Vorhangkonzept integrieren.

Das Aluminiumprofil überzeugt durch elegante Optik, Funktionalität und eine zuverlässige Wärmeableitung, besonders wenn das Flexband unterhalb des Vorhangs eingesetzt wird. Flexband, Vorhang oder beides lassen sich flexibel kombinieren.

Das VP2 eignet sich ideal für Wohnräume, Gastronomie oder Showrooms – überall dort, wo unauffällige und dennoch effektive Beleuchtung gefragt ist. Mit Zubehör wie Endkappen, Abdeckungen oder Vorhangblenden entsteht ein harmonisches Gesamtbild.

Die Profilabdeckungen aus bruchsicherem, schwer entflammarem Polycarbonat (UL94 V-2) sind in Opal/satiniert (65 %), Schwarz/matt (25 %) und Klar (85 %) erhältlich. Sie sorgen für homogene Lichtverhältnisse und eine hohe Lichtausbeute.

*Klassifizierung Brennbarkeit UL94 V-2: Verlöschen einer vertikal eingespannten Probe innerhalb von 30 Sekunden

GALAXY profiles
Perfect Light Lines



VP2 + C1

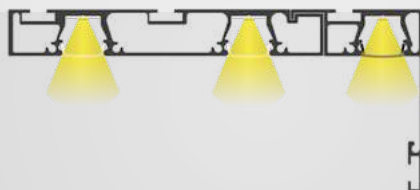

VP2 + C1 + VP4 + C32

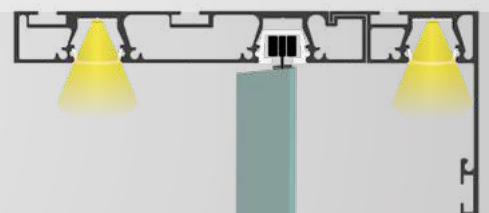

VP2 + C1 + CV1 + Z66 + VP4 + C1

max.
10 mm

OEM

GALAXY profiles
Perfect Light Lines

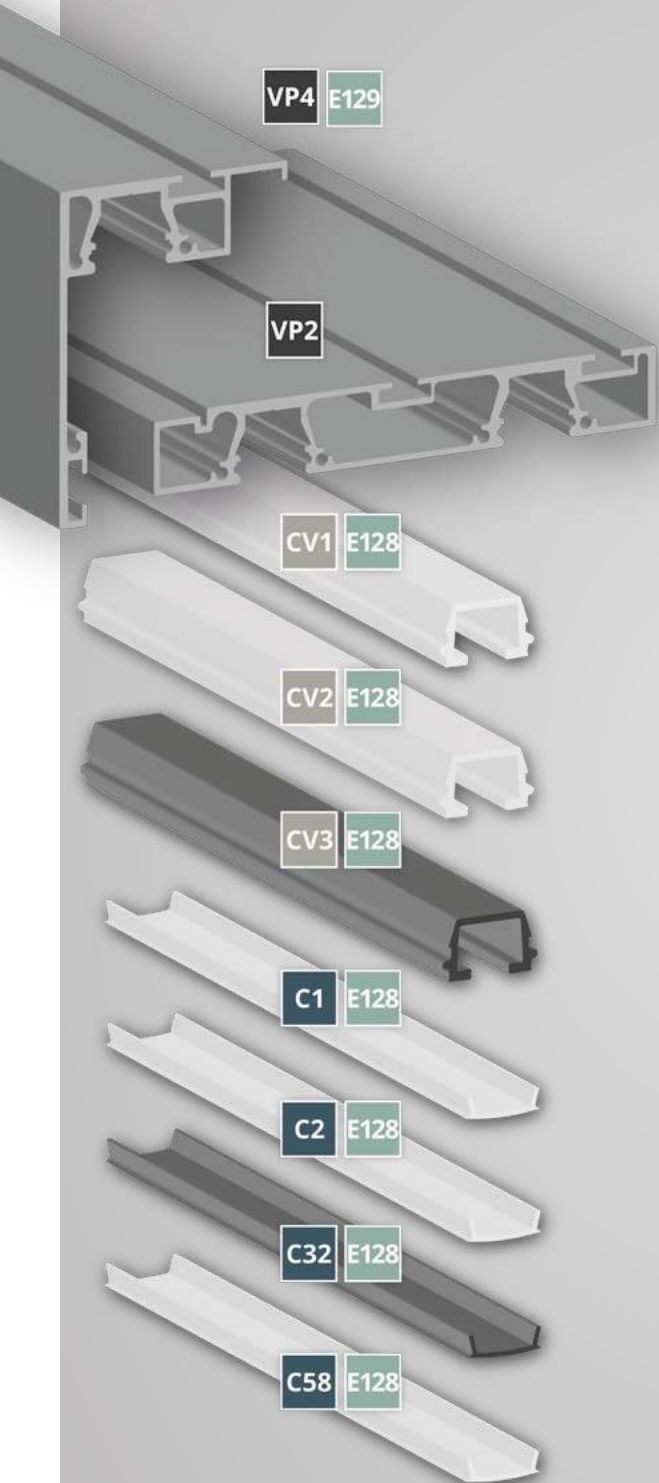

PC-INLAYS

CV1 65 %	100cm 8123581	200 cm 8123550
CV2 85 %	100 cm 8123582	200 cm 8123551
CV3 25 %	100 cm 8123593	200 cm 8123592

COVERS | ABDECKUNGEN

C1 65 %	200cm 8600004	250 cm 8600026	300 cm 8600080	600 cm 8600037
C2 85 %	200 cm 8600003	250 cm 8600135	300 cm 8600136	
C58 75 %	200 cm 8600154			
C32 25 %	200 cm 8600070	300 cm 8600103	600 cm 8600071	

END CAPS | ENDKAPPEN

E128	E128W 8192326	E128B 8192325
E129	E129W 8192320	E129B 8192319

PROFILE

VP2	200 cm 8123541	200 cm 8123540			
VP4	200 cm 8123543	200 cm 8123542			
	Z25 8301513				
	Z66 100 pcs./stk. 8192335				
Z67	2 pcs./stk. 8192332	2 pcs./stk. 8192331	Z68	2 pcs./stk. 8192334	2 pcs./stk. 8192333
Z72	opal opal 8192336	clear klar 8123610	black schwarz 8192337	Z73	8123552

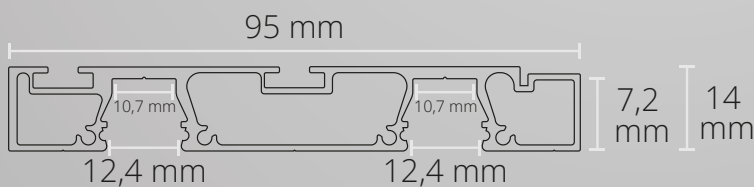

392

INSTALLATION INSTRUCTION
INSTALLATIONS MONTAGE



VP2 CURTAIN | GARDINEN NEW

Double | Zweibahnig | LED Strips max. 10 mm

95 mm x 14 mm | 894 g/m

□ 200 cm
8123541

■ 200 cm
8123540



VP4 NEW

Curtain visor, 200 cm
Gardinenblende, 200 cm

□ **8123543**

■ **8123542**

max.
10 mm



OEM

Z66 NEW

Roller glider for PC-Inlay | 100 pcs.
Rollengleiter für PC-Inlay | 100 stk.

8192335



Z67 NEW

Wall fitting, short | 2 pcs.
Wandbeschlag, kurz | 2 stk.

□ **8192332**

■ **8192331**



Z68 NEW

Wall fitting, long | 2 pcs.
Wandbeschlag, lang | 2 stk.

□ **8192334**

■ **8192333**



Z25

Connector | Verbinder
Steel | Stahl | 4 PCS/STK

□ 180°
8301513



Z72 NEW

Curtain insertion aid
Vorhangschleuse

opal | opal **8192336**

clear | klar **8123610**

black | schwarz **8192337**



Z73 NEW

Lock for curtain track
Feststeller für Vorhanglauf

8123552



COVERS | ABDECKUNGEN



C1 opal/satinised | opal/satiniert | 65 %

PC | 13,81 mm x 4,37 mm

200cm
8600004

250cm
8600026

600cm
8600037



C2 transparent | klar | 85 %

PC | 13,81 mm x 4,37 mm

200cm
8600003

250cm
8600135

300cm
8600136

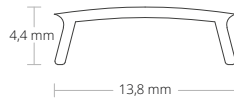

C32 black/matt | schwarz/matt | 25 %

PC | 13,81 mm x 4,37 mm

200cm
8600070

600cm
8600071



C58 white/matt | weiß/matt | 75 %

PC | 13,8 mm x 4,4 mm

200cm
8600154

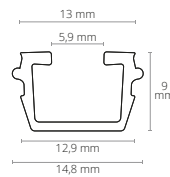

CV1 opal/satinised | opal/satiniert | 65 % NEW

PC | 14,8 mm x 9 mm

100cm
8123581

200cm
8123550

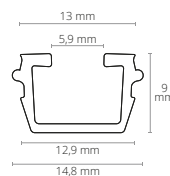

CV2 clear | klar | 85 % NEW

PC | 14,8 mm x 9 mm

100cm
8123582

200cm
8123551

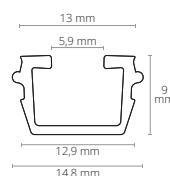

CV3 black/matt | schwarz/matt | 25 % NEW

PC | 14,8 mm x 9 mm

100cm
8123593

200cm
8123592

END CAPS | ENDKAPPEN



E128 PVC | 1 PCS/STK NEW

□ E128W
8192326

■ E128B
8192325



E129 PVC | 1 PCS/STK | for VP4 | für VP4 NEW

□ E129W
8192320

■ E129B
8192319

VP3

CURTAIN | GARDINEN

100 cm | 200 cm

max. 10 mm

OEM

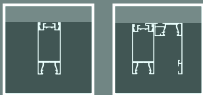

NEW TO OUR RANGE
IM SORTIMENT

EXTENSION OF SERVICE LIFE
VERLÄNGERUNG LEBENSDAUER

MECHANICAL PROTECTION
MECHANISCHER SCHUTZ

COOLING
KÜHLUNG

HIGH LIGHT UTILISATION
HOHE LICHTVERWERTUNG

HOMOGENEOUS LIGHT
HOMOGENES LICHT

HOMOGENEOUS LIGHT with modular LED light solutions

- Ceiling mounting
Deckenmontage
- Home accessories
Wohnaccessoires
- Cabinet doors | Schranktüren
- Living spaces | Wohnräume
- Offices | Büroräume
- Hotel and gastronomy business
Hotellerie und Gastronomie
- Retail (shop and showcase windows)
Einzelhandel (Shop- und Schaufenster)
- Business areas and showrooms
Geschäftsflächen und Showrooms
- Barber / Beauty / body art studios
Friseur-/Beauty-/Body-Art-Studios
- Halls, foyers and corridors
Hallen, Foyers und Flure
- Wellness and indoor leisure facilities
Wellness- und Indoor-Freizeitanlagen
- Medical practice | Arztpraxis
- School | Schule
- Theatre & exhibition spaces
Theater & Ausstellungsflächen
- Museums | Museen

Mounting/installation on/in wood Strips and plates, plasterboard, tiles, stone, granite, marble and metal surfaces
Montage/Einbau auf/in Holzleisten und -platten, Gipsplatten, Fliesen, Stein-, Granit-, Marmor- und Metalloberflächen



VP3

CURTAIN | GARDINEN

High | Hoch | LED Strips max. 10 mm

 RAL 9010 White/Weiß
 POWDER-COATED | PULVERBESCHICHTET

 RAL 9005 Black/Schwarz
 POWDER-COATED | PULVERBESCHICHTET

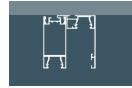

max. 10 mm

The VP3 LED curtain profile is designed for LED flex strips up to 10 mm wide and is versatile for indoor use. It can be fitted with flex strips or – in combination with PC inlays – used as a curtain rail. Its tall, narrow design gives it a particularly delicate and discreet appearance.

The aluminium profile impresses with its simple look, functionality and reliable heat dissipation, especially when used with flexible strips under curtains. Flexible tape, curtains or both can be combined flexibly.

The VP3 is ideal for private homes, hotels or wellness areas – anywhere where modern and stylish lighting is required. Accessories such as end caps, covers or curtain panels can be used to achieve a harmonious overall look.

The profile covers made of shatterproof, flame-retardant polycarbonate (UL94 V-2) are available in opal/satin (65%), black/matt (25%) and clear (85%). They ensure uniform light and high efficiency.

* Classification flammability UL94 V-2: Extinguishing of a vertically clamped sample within 30 seconds

Das VP3 LED Gardinenprofil ist für LED-Flexbänder bis 10 mm Breite ausgelegt und vielseitig im Innenbereich einsetzbar. Es kann mit Flexband bestückt oder – in Kombination mit PC-Inlays – als Vorhangsschiene genutzt werden. Durch seine hohe, schmale Bauweise wirkt es besonders filigran und dezent.

Das Aluminiumprofil überzeugt durch schlichte Optik, Funktionalität und zuverlässige Wärmeableitung, vor allem bei unter dem Vorhang eingesetztem Flexband. Flexband, Vorhang oder beides können flexibel kombiniert werden.

Das VP3 eignet sich ideal für Privathäuser, Hotellerie oder Wellnessbereiche – überall dort, wo moderne und stilvolle Beleuchtung gefragt ist. Mit Zubehör wie Endkappen, Abdeckungen oder Vorhangblenden lässt sich ein harmonisches Gesamtbild erzielen.

Die Profilabdeckungen aus bruchsicherem, schwer entflammablem Polycarbonat (UL94 V-2) sind in Opal/satiniert (65 %), Schwarz/matt (25 %) und Klar (85 %) erhältlich. Sie sorgen für gleichmäßiges Licht und hohe Effizienz.

*Klassifizierung Brennbarkeit UL94 V-2: Verlöschen einer vertikal eingespannten Probe innerhalb von 30 Sekunden

GALAXY profiles
Perfect Light Lines

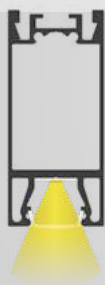

VP3 + C1

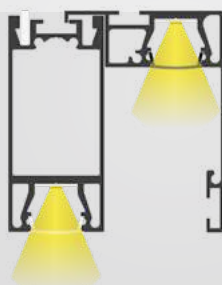

VP3 + C1 + VP4 + C32 + Z25

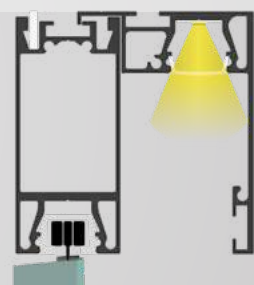

VP3 + CV2 + Z66 + VP4 + C1 + Z25

GALAXY profiles
Perfect Light Lines



max.
10 mm

OEM



PC-INLAYS

CV1 65 %	100cm 8123581	200 cm 8123550
CV2 85 %	100 cm 8123582	200 cm 8123551
CV3 25 %	100 cm 8123593	200 cm 8123592

COVERS | ABDECKUNGEN

C1 65 %	200cm 8600004	250 cm 8600026	300 cm 8600080	600 cm 8600037
C2 85 %	200 cm 8600003	250 cm 8600135	300 cm 8600136	
C58 75 %	200 cm 8600154			
C32 25 %	200 cm 8600070	300 cm 8600103	600 cm 8600071	

END CAPS | ENDKAPPEN

E130	E130W 8192330	E130B 8192329
E131	E131W 8192317	E131B 8192318

PROFILE

VP3	200 cm 8123559	200 cm 8123558		
VP4	200 cm 8123543	200 cm 8123542		
	Z25 8301513			
	Z66 100 pcs./stk. 8192335			
Z67	2 pcs./stk. 8192332	2 pcs./stk. 8192331	Z68 2 pcs./stk. 8192334	2 pcs./stk. 8192333
Z72	opal opal 8192336	clear klar 8123610	black schwarz 8192337	Z73 8123552

INSTALLATION INSTRUCTION
INSTALLATIONS MONTAGE

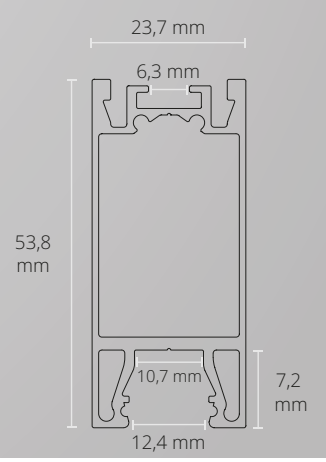



VP3 CURTAIN | GARDINEN NEW

High | Hoch | LED Strips max. 10 mm

53,8 mm x 23,7 mm | 718 g/m

□ 200 cm
8123559

■ 200 cm
8123558



VP4 NEW

Curtain visor, 200 cm
Gardinenblende, 200 cm

□ **8123543**

■ **8123542**

max.
10 mm



OEM

Z66 NEW

Roller glider for PC-Inlay | 100 pcs.
Rollengleiter für PC-Inlay | 100 stk.

8192335



Z67 NEW

Wall fitting, short | 2 pcs.
Wandbeschlag, kurz | 2 stk.

□ **8192332**

■ **8192331**



Z68 NEW

Wall fitting, long | 2 pcs.
Wandbeschlag, lang | 2 stk.

□ **8192334**

■ **8192333**



Z25

Connector | Verbinder
Steel | Stahl | 4 PCS/STK

180°
8301513



Z72 NEW

Curtain insertion aid
Vorhangschleuse

opal | opal **8192336**

clear | klar **8123610**

black | schwarz **8192337**



Z73 NEW

Lock for curtain track
Feststeller für Vorhanglauf

8123552



COVERS | ABDECKUNGEN

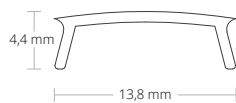

C1 opal/satinised | opal/satiniert | 65 %

PC | 13,81 mm x 4,37 mm

200cm
8600004

250cm
8600026

600cm
8600037

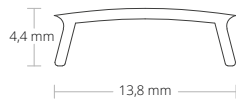

C2 transparent | klar | 85 %

PC | 13,81 mm x 4,37 mm

200cm
8600003

250cm
8600135

300cm
8600136



C32 black/matt | schwarz/matt | 25 %

PC | 13,81 mm x 4,37 mm

200cm
8600070

600cm
8600071

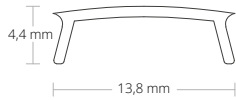

C58 white/matt | weiß/matt | 75 %

PC | 13,8 mm x 4,4 mm

200cm
8600154

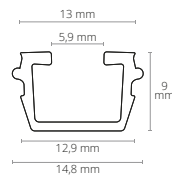

CV1 opal/satinised | opal/satiniert | 65 % NEW

PC | 14,8 mm x 9 mm

100cm
8123581

200cm
8123550

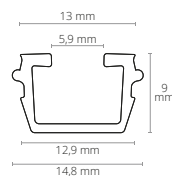

CV2 clear | klar | 85 % NEW

PC | 14,8 mm x 9 mm

100cm
8123582

200cm
8123551

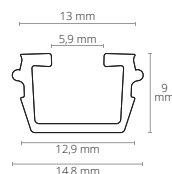

CV3 black/matt | schwarz/matt | 25 % NEW

PC | 14,8 mm x 9 mm

100cm
8123593

200cm
8123592

END CAPS | ENDKAPPEN



E130 PVC | 1 PCS/STK NEW

□ E130W
8192330

■ E130B
8192329



E131 PVC | 1 PCS/STK | for VP4 | für VP4 NEW

□ E131W
8192317

■ E131B
8192318

VP5

CURTAIN | GARDINEN

100 cm | 200 cm

max. 10 mm

■ OEM

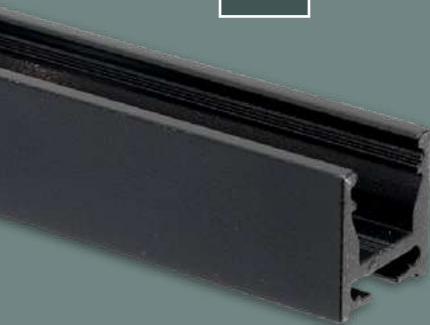

NEW TO OUR RANGE
IM SORTIMENT

EXTENSION OF SERVICE LIFE
VERLÄNGERUNG LEBENSDAUER

MECHANICAL PROTECTION
MECHANISCHER SCHUTZ

COOLING
KÜHLUNG

HIGH LIGHT UTILISATION
HOHE LICHTVERWERTUNG

HOMOGENEOUS LIGHT
HOMOGENES LICHT

HOMOGENEOUS LIGHT with modular LED light solutions

- Ceiling mounting
Deckenmontage
- Home accessories
Wohnaccessoires
- Cabinet doors | Schranktüren
- Living spaces | Wohnräume
- Offices | Büroräume
- Hotel and gastronomy business
Hotellerie und Gastronomie
- Retail (shop and showcase windows)
Einzelhandel (Shop- und Schaufenster)
- Business areas and showrooms
Geschäftsflächen und Showrooms
- Barber / Beauty / body art studios
Friseur-/Beauty-/Body-Art-Studios
- Halls, foyers and corridors
Hallen, Foyers und Flure
- Wellness and indoor leisure facilities
Wellness- und Indoor-Freizeitanlagen
- Medical practice | Arztpraxis
- School | Schule
- Theatre & exhibition spaces
Theater & Ausstellungsflächen
- Museums | Museen

Mounting/installation on/in wood Strips and plates, plasterboard, tiles, stone, granite, marble and metal surfaces
Montage/Einbau auf/in Holzleisten und -platten, Gipsplatten, Fliesen, Stein-, Granit-, Marmor- und Metalloberflächen



VP5

CURTAIN | GARDINEN

Flat | Flach | LED Strips max. 10 mm

□ RAL 9010 White/Weiß
POWDER-COATED | PULVERBESCHICHTET

■ RAL 9005 Black/Schwarz
POWDER-COATED | PULVERBESCHICHTET



max. 10 mm

The VP5 LED curtain profile is designed for LED flex strips up to 10 mm wide and is versatile for indoor use. It can be fitted with flex strips or – in combination with PC inlays – used as a curtain rail. Thanks to its flat, narrow design, it fits inconspicuously in front of any window without obstructing the view or daylight.

The aluminium profile impresses with its simple appearance, functionality and reliable heat dissipation, especially when flex tape is used under the curtain. Flex tape, curtains or both can be combined flexibly.

The VP5 is ideal for private homes, hotels or restaurants and enables the elegant integration of LED lighting with uniform illumination of curtains. Accessories such as end caps and covers create a harmonious overall look.

The covers are made of shatterproof, flame-retardant polycarbonate (UL94 V-2) and are available in opal/satin (65%), black/matt (25%) and clear (85%). They ensure homogeneous light and high efficiency

* Classification flammability UL94 V-2: Extinguishing of a vertically clamped sample within 30 seconds

Das VP5 LED Gardinenprofil ist für LED-Flexbänder bis 10 mm Breite ausgelegt und vielseitig im Innenbereich nutzbar. Es kann mit Flexband bestückt oder – in Kombination mit PC-Inlays – als Vorhangschiene verwendet werden. Durch die flache, schmale Bauweise fügt es sich unauffällig vor jedes Fenster ein, ohne den Blick oder das Tageslicht zu stören.

Das Aluminiumprofil überzeugt durch schlichte Optik, Funktionalität und eine zuverlässige Wärmeableitung, besonders bei unter dem Vorhang eingesetztem Flexband. Flexband, Vorhang oder beides können flexibel kombiniert werden.

Das VP5 eignet sich ideal für Privathäuser, Hotellerie oder Gastronomie und ermöglicht eine elegante Integration von LED-Beleuchtung mit gleichmäßiger Ausleuchtung von Vorhängen. Mit Zubehör wie Endkappen & Abdeckungen entsteht ein stimmiges Gesamtbild.

Die Abdeckungen aus bruchsicherem, schwer entflammbarem Polycarbonat (UL94 V-2) sind in Opal/satiniert (65 %), Schwarz/matt (25 %) und Klar (85 %) erhältlich. Sie sorgen für homogenes Licht und hohe Effizienz.

*Klassifizierung Brennbarkeit UL94 V-2: Verlöschen einer vertikal eingespannten Probe innerhalb von 30 Sekunden

GALAXY profiles
Perfect Light Lines



VP5 + C1



VP5 + CV2

max.
10 mm

OEM

GALAXY profiles
Perfect Light Lines

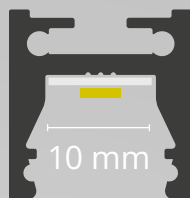

PC-INLAYS

CV1 65 %	100cm 8123581	200 cm 8123550
CV2 85 %	100 cm 8123582	200 cm 8123551
CV3 25 %	100 cm 8123593	200 cm 8123592

COVERS | ABDECKUNGEN

C1 65 %	200cm 8600004	250 cm 8600026	300 cm 8600080	600 cm 8600037
C2 85 %	200 cm 8600003	250 cm 8600135	300 cm 8600136	
C58 75 %	200 cm 8600154			
C32 25 %	200 cm 8600070	300 cm 8600103	600 cm 8600071	

END CAPS | ENDKAPPEN

E132	E132W 8192324	E132B 8192323
E133	E133W 8192321	E133B 8192322

PROFILE

VP5	200 cm 8123574	200 cm 8123573			
Z25	8301513				
Z66	100 pcs./stk. 8192335				
Z67	2 pcs./stk. 8192332	2 pcs./stk. 8192331	Z68	2 pcs./stk. 8192334	2 pcs./stk. 8192333
Z72	opal opal 8192336	clear klar 8123610	black schwarz 8192337	Z73	8123552

INSTALLATION INSTRUCTION
INSTALLATIONS MONTAGE

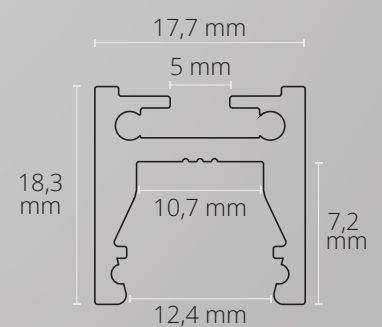



VP5 CURTAIN | GARDINEN

NEW

Flat | Flach | LED Strips max. 10 mm

17,7 mm x 18,3 mm | 332 g/m

200 cm
8123574

200 cm
8123573

max.
10 mm



OEM

Z66 NEW

Roller glider for PC-Inlay | 100 pcs.
Rollengleiter für PC-Inlay | 100 stk.

8192335



Z67 NEW

Wall fitting, short | 2 pcs.
Wandbeschlag, kurz | 2 stk.

8192332
8192331



Z68 NEW

Wall fitting, long | 2 pcs.
Wandbeschlag, lang | 2 stk.

8192334
8192333



Z25

Connector | Verbinder
Steel | Stahl | 4 PCS/STK

180°
8301513



Z72 NEW

Curtain insertion aid
Vorhangschleuse

opal | opal 8192336
clear | klar 8123610
black | schwarz 8192337



Z73 NEW

Lock for curtain track
Feststeller für Vorhanglauf

8123552



COVERS | ABDECKUNGEN

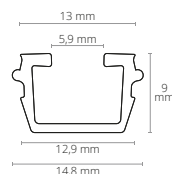
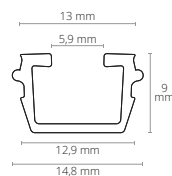
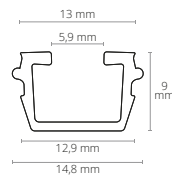
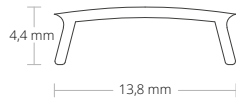
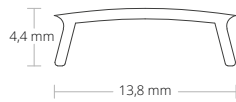
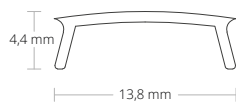

C1 opal/satinised | opal/satiniert | 65 %

PC | 13,81 mm x 4,37 mm

200cm 8600004 250cm 8600026 600cm 8600037

C2 transparent | klar | 85 %

PC | 13,81 mm x 4,37 mm

200cm 8600003 250cm 8600135 300cm 8600136

C32 black/matt | schwarz/matt | 25 %

PC | 13,81 mm x 4,37 mm

200cm 8600070 600cm 8600071

C58 white/matt | weiß/matt | 75 %

PC | 13,8 mm x 4,4 mm

200cm 8600154

CV1 opal/satinised | opal/satiniert | 65 % NEW

PC | 14,8 mm x 9 mm

100cm 8123581 200cm 8123550

CV2 clear | klar | 85 % NEW

PC | 14,8 mm x 9 mm

100cm 8123582 200cm 8123551

CV3 black/matt | schwarz/matt | 25 % NEW

PC | 14,8 mm x 9 mm

100cm 8123593 200cm 8123592

END CAPS | ENDKAPPEN



E132 PVC | 1 PCS/STK NEW

E132W
8192324

E132B
8192323



VP4 NEW

Curtain visor | Gardinenblende

□ 2 m 8123543

■ 2 m 8123542

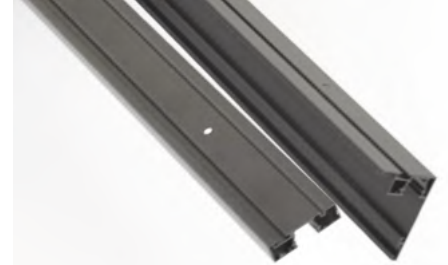

Can be combined with all curtain profiles. The cover is suitable for creating indirect lighting accents.

Kombinierbar mit allen Gardinenprofilen. Die Blende ist dazu geeignet indirekte Lichtakzente zu setzen.



Wall fitting | Wandbeschlag
8192331





Glue in the flex stripe
Flexband einkleben



Click in the curtain inlay
Gardinen-Inlay einklicken



Hang curtain with Z66
Gardine mit Z66 einhängen

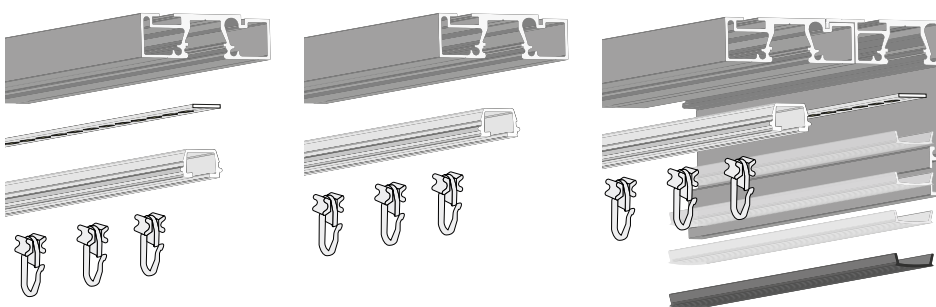

Combination options:

1. Illuminated with flex strip and inlay
2. Only with Z66 without light
3. Illuminated in combination with the VP4 visor

Kombinationsmöglichkeiten

1. Leuchtend mit Flexband und Inlay
2. Nur mit Z66 ohne Licht
3. Leuchtend in Kombination mit der VP4 Blende

Note: If the LED stripe is installed under the track insert and the curtain, it must not exceed a maximum height of 2.6 mm.



**LATERALLY BENDABLE
SEITLICH BIEGBAR**



The SV series profiles are ideal for flexbands with silicone sealing. These flexbands are characterised by their high flexibility, durability and heat resistance and can be used in combination with our flexible SV profiles to create extraordinary lighting installations. Even challenging areas such as curves can be perfectly illuminated in this way.



Die Profile der SV-Serie sind ideal für Flexbänder mit Silikonverguss geeignet. Diese Flexbänder zeichnen sich durch ihre hohe Flexibilität, Widerstandsfähigkeit und Hitzebeständigkeit aus.

In Kombination mit unseren flexiblen SV-Profilen lassen sich damit außergewöhnliche Lichtinstallationen realisieren. Selbst herausfordernde Bereiche wie Rundungen können auf diese Weise perfekt ausgeleuchtet werden.



SV1 SURFACE | AUFBAU

for light tubes W: 4 mm / H: 8 mm | für Lichtschläuche B: 4 mm / H: 8 mm
LED Strips max. 4 mm

100 cm
8123441

SV2 SURFACE | AUFBAU

for light tubes W: 8 mm / H: 12 mm | für Lichtschläuche B: 8 mm / H: 12 mm
LED Strips max. 8 mm

100 cm
8123442

SV3 SURFACE | AUFBAU

for light tubes W: 16 mm / H: 16 mm | für Lichtschläuche B: 16 mm / H: 16 mm
LED Strips max. 16 mm

100 cm
8123443

SV4 SURFACE | AUFBAU

for light tubes W: 13 mm / H: 13 mm | für Lichtschläuche B: 13 mm / H: 13 mm
LED Strips max. 13 mm

100 cm
8123444

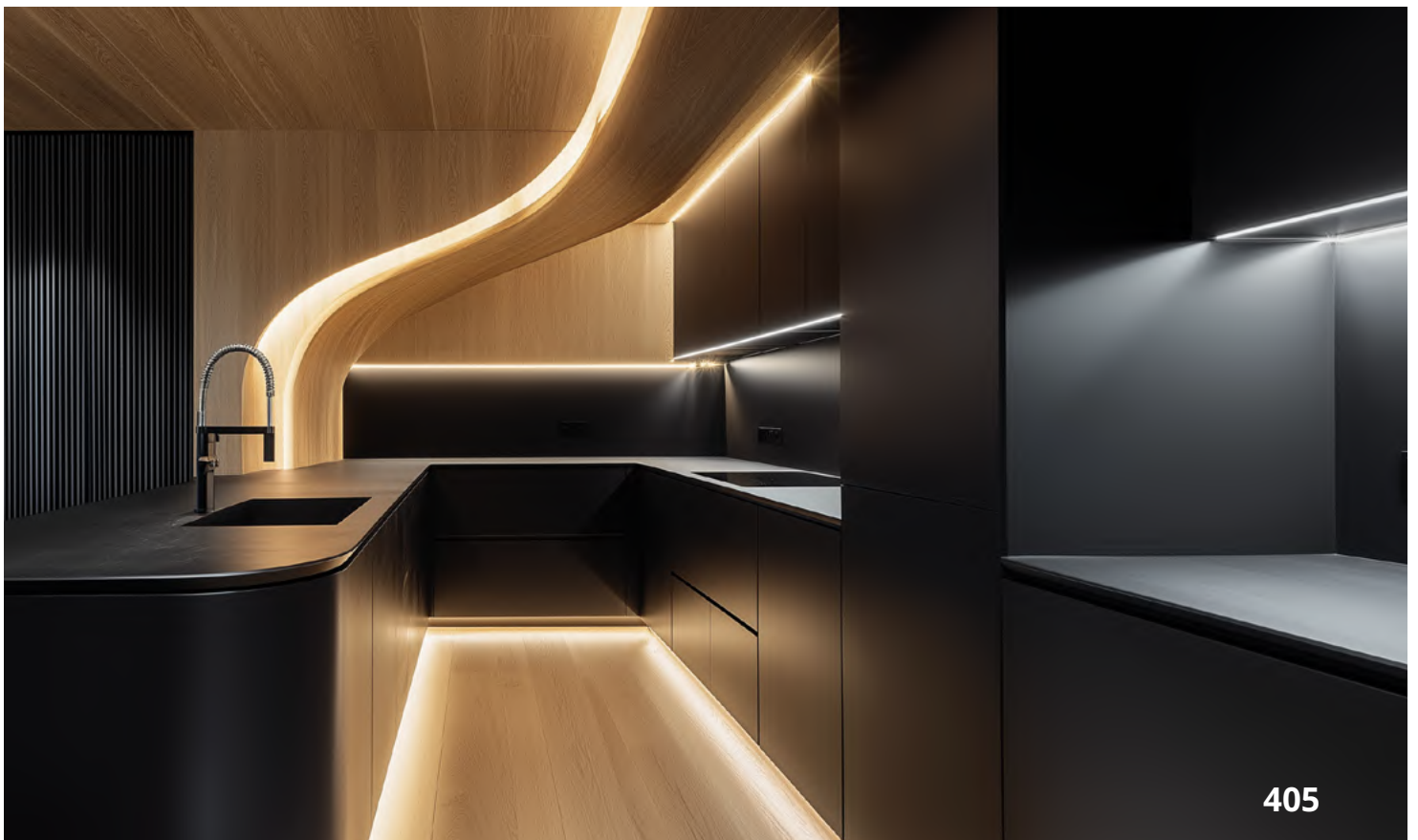



Z50

Connecting element | Verbindungselement
8123360

With the Z50 connecting element, you can combine the profiles mentioned as required. This opens up new possibilities for a lighting solution.

Mit dem Verbindungselement Z50 können Sie die genannten Profilen wie gewünscht kombinieren. Dadurch entstehen neue Möglichkeiten für eine Beleuchtungslösung.

Compatible with connecting element Z50
Kompatibel mit Verbindungselement Z50

PN8

PN6V2

PN4

PN17V1

PN17V2

LL2

PN19V3

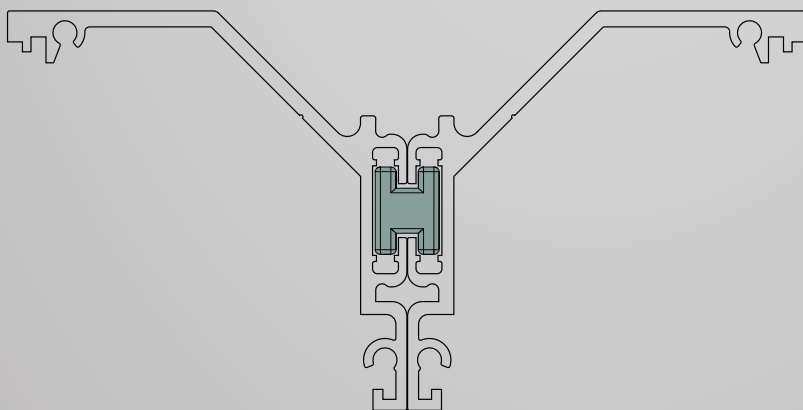
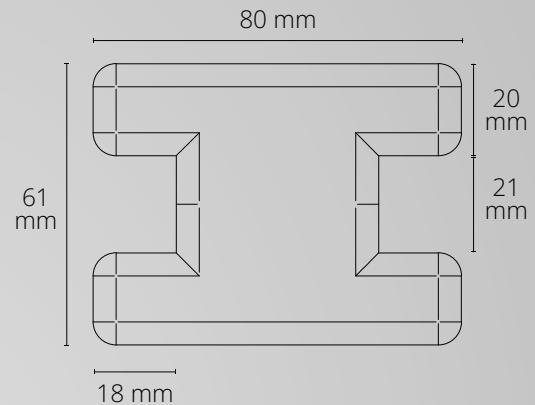

PN19V3 + Z50

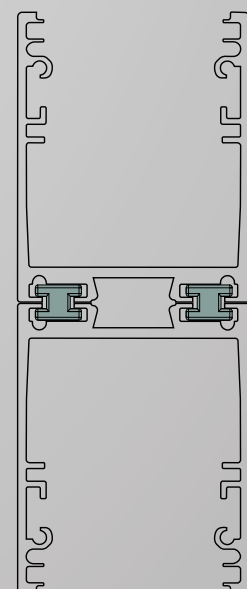

PN17V2 + Z50



Z51

Connecting element | Verbindungselement 8123361

With the Z51 connecting element, you can take your indirect lighting to a new level and create unique projects.

Mit dem Verbindungselement Z51 bringen Sie ihre indirekte Beleuchtung auf eine neue Stufe und gestalten einzigartige Projekte.

Compatible with connecting element Z51
Kompatibel mit Verbindungselement Z51

VA1

VA3

VA4

VA5

VA6

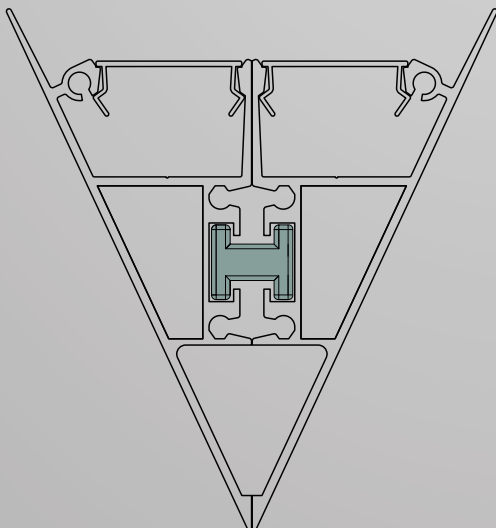
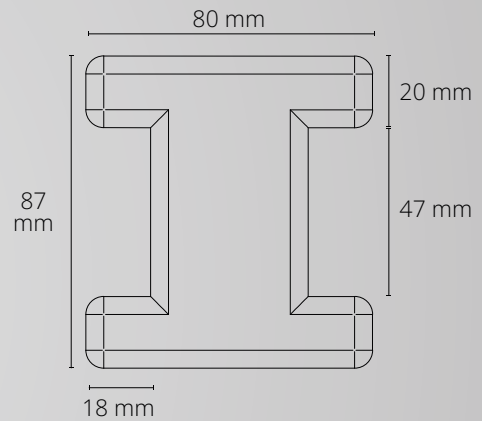

VA3 + Z51

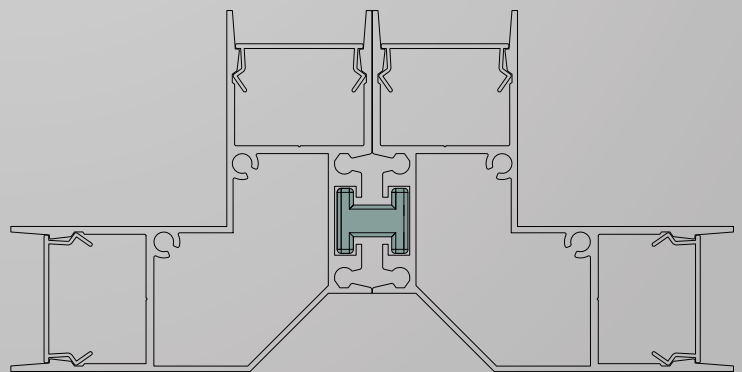

VA5 + Z51





GALAXY[®] profiles

PUR Grouting
PUR-Vollverguss



Sustainable sealing with premium PUR Grouting

IP67

2 year guarantee

WE GRANT A
2 YEAR GUARANTEE
SUBJECT TO PROPER AND
INTENDED USE

MULTI-LAYER GROUTING PROCESS

In order to be able to operate linear LED lighting concepts safely and without malfunctions in wet rooms, humid rooms, in the outdoor area and especially under water, a minimum degree of protection IP67 must be guaranteed.

Protection for Chips and Electronics

The resin covers the LED stripe, the connector wiring, as well as the entire interior of the profile and forms a flush seal with the upper edge and the side edges. The linear LED lighting component is now sealed and completely waterproof. Further advantages are offered by the protection of the LED chips and electronics, as well as by reducing the mechanical tension of the aluminium profile.

Excellent properties for lasting added value!

- Waterproofness: Protection class IP67
- Salt spray/chlorine/UV-resistant
- High temperature resistance
(Ambient temperature: -40° - 90°)
- High spall and wear resistance
- No yellowing
- Supports foot and vehicle traffic
- NO heat accumulation in the LED strip

Exact product specifications with technical parameters and measurement results are available for each order.

GROUTING FOR ALL LED PROFILE SYSTEMS

All LED profile systems from GALAXY® profiles can be sealed with this method (up to a profile length of max. 5.5 m). Depending on the thickness and the colour (clear or opal satin) of the grouting, you can achieve varying light transmittance.

Individual offers within three days!

- No minimum order quantity - single order up to serial sealing
- Made to measure and to specific technical parameters
- Delivery in two to three weeks after order confirmation

We are happy to advise you and make you an individual offer!

SEND US YOUR INQUIRY





Nachhaltige Versiegelung mit Premium PUR-Vollverguss

IP67

2 Jahre Garantie

WIR GEWÄHREN
2 JAHRE GARANTIE
BEI ORDNUNGSGEMÄSSEN UND
ZWECKGEBUNDENEM EINSATZ

MEHRSTUFIGES VOLLVERGUSSVERFAHREN

Um lineare LED Beleuchtungskonzepte sicher und störungsfrei in Nasszellen, Feuchträumen, im Outdoorbereich und insbesondere unter Wasser betreiben zu können, muss mindestens die Schutzart IP67 gewährleistet sein.

Schutz für Chip und Elektronik

Das Harz bedeckt das LED Flexband, die Anschlussverkabelung sowie den gesamten Innenraum des Profils und schließt bündig mit der Oberkante bzw. den seitlichen Kanten ab. Das lineare LED Lichtbauelement ist nun versiegelt und absolut wasserdicht. Weitere Vorteile sind der Schutz der LED Chips und der Elektronik sowie die Reduktion der mechanischen Spannung des Alu-Profils.

Ausgezeichnete Eigenschaften für nachhaltigen Mehrwert!

- Dichtheit: Schutzart IP67
- Salzsprüh-/ Chlor-/ UV-Beständig
- Hohe Temperaturbeständigkeit (Umgebungstemperatur: -40° - 90°)
- Hohe Steinsplitter- und Abriebbeständigkeit
- Keine Vergilbung
- Begeh- und befahrbar
- KEIN Wärmestau am LED Streifen

Exakte Produktspezifikation mit technischen Parametern und Messergebnissen sind zu jedem Auftrag verfügbar.

VOLLVERGUSS FÜR ALLE LED PROFILSYSTEME

Alle LED Profilsysteme von GALAXY® profiles können mit diesem Verfahren versiegelt werden (bis zur Profillänge von max. 5,5 m Länge). Abhängig von der Stärke und der Farbe (klar oder opal satiniert) des Vollvergusses erzielt man eine unterschiedliche Lichtdurchlässigkeit.

Individuelle Angebote innerhalb von drei Tagen!

- Keine Mindestbestellmenge – Einzelauftrag bis hin zur Serienversiegelung
- Fertigung nach Maß und spezifischer technischer Parameter
- Lieferzeit zwei bis drei Wochen nach Auftragsbestätigung

Wir beraten Sie und erstellen Ihnen gerne ein individuelles Angebot!

SENDEN SIE UNS IHRE ANFRAGE!



PA1

OUTDOOR

100 cm | 600 cm

max. 20 mm

OEM



EXTENSION OF SERVICE LIFE
VERLÄNGERUNG LEBENSDAUER

MECHANICAL PROTECTION
MECHANISCHER SCHUTZ

COOLING
KÜHLUNG

HIGH LIGHT UTILISATION
HOHE LICHTVERWERTUNG

HOMOGENEOUS LIGHT
HOMOGENES LICHT

HOMOGENEOUS LIGHT with modular LED light solutions

- Stairs and railings
Treppenstufen und -Geländer
- Balustrades | Balustraden
- Façades, balconies and terraces
Fassaden, Balkone und Terrassen
- Gardens/green spaces
Gärten/Grünanlagen
- Parks | Parkanlagen
- Access roads | Zufahrten
- Parking spaces | Parkplätze
- Hotel and gastronomy business
Hotellerie und Gastronomie
- Retail (shop and showcase windows)
Einzelhandel (Shop- und Schaufenster)
- Business areas and showrooms
Geschäftsflächen und Showrooms
- Barber / Beauty / body art studios
Friseur-/Beauty-/Body-Art-Studios
- Halls, foyers and corridors
Hallen, Foyers und Flure
- Wellness and indoor leisure facilities
Wellness- und Indoor-Freizeitanlagen
- Wet rooms | Nasszellen

Mounting/installation on/in wood Strips and plates, plasterboard, tiles, stone, granite, marble and metal surfaces
Montage/Einbau auf/in Holzleisten und -platten, Gipsplatten, Fliesen, Stein-, Granit-, Marmor- und Metalloberflächen



PA1

OUTDOOR

Silver/Silber
PCB ALUMINIUM

PA1 LED Linear Systems Outdoor are waterproof and dirt resistant. They are LED stripes encapsulated in aluminium profiles with ready-to-connect cabling (protection class IP67). The system is fully encapsulated according to the custom requirements to ensure sufficient protection for a long service life.

The aluminium profiles (PCB aluminium) are PU-coated and thus protected against yellowing.

We provide a 2-year warranty when used properly and according to their design.

Further details of sealing with Premium PUR full encapsulation on page 410.

These linear systems can be driven over and, with appropriate mounting rails, are very flexible and can be used in gardens, parks, driveways as well as on house and building facades as staging decorative/effect lighting or as path-indicating emergency lighting.

PA1 LED Linearsysteme Outdoor sind wasserdicht und schmutzfest. Sie sind in Aluminiumprofile eingefasste LED Flexbänder mit anschlussfertiger Verkabelung (Schutzart IP67). Das System wird individuell je nach Anforderung vollvergossen, um ausreichenden Schutz für eine lange Lebensdauer gewährleisten zu können.

Die Aluminiumprofile (PCB Aluminium) sind PU-beschichtet und damit vor Vergilbung geschützt.

Wir gewähren 2 Jahre Garantie bei ordnungsgemäßem und zweckgebundenem Einsatz.

Weitere Details der Versiegelung mit Premium PUR-Vollverguss auf S. 412.

Diese Linearsysteme sind befahrbar und mit entsprechenden Montageschienen sehr flexibel und vielfältig in Gärten, Parkanlagen, Zufahrten sowie an Haus- und Gebäudefassaden als inszenierende Dekor-/Effektbeleuchtung oder als wegweisende Sicherheitsbeleuchtung einsetzbar.

GALAXY profiles
Perfect Light Lines

PA1 + MR1

PA1 + MR2

PA1 + MR3

415

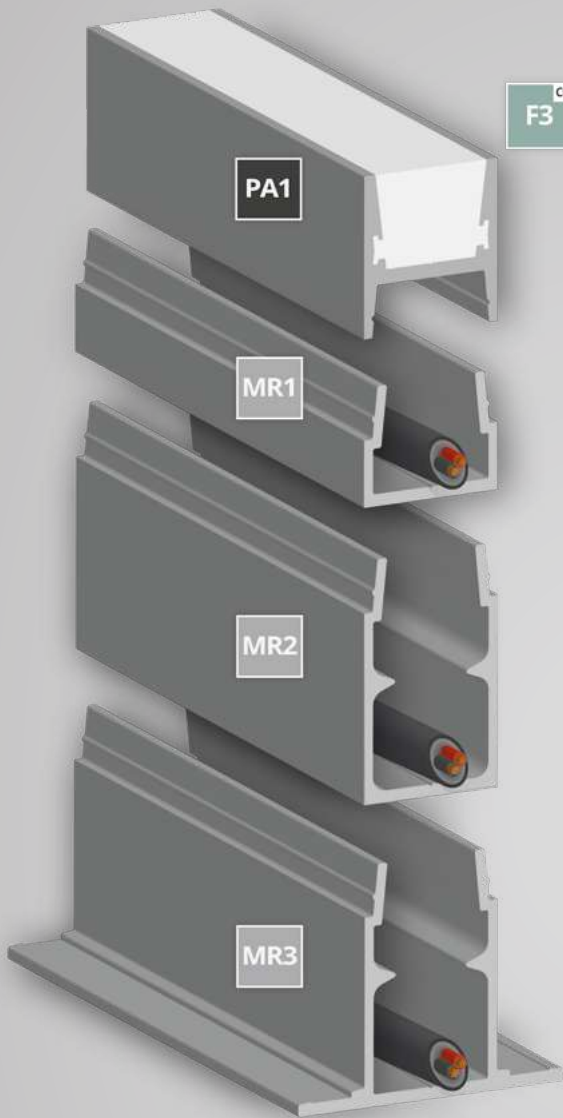

PROFILE

PA1  100 cm **8106501**  600 cm **8106503**

FLUSH-MOUNT | MONTAGESCHIENE

MR1  100 cm **8106560**

MR2  100 cm **8106530**

MR3  100 cm **8106540**

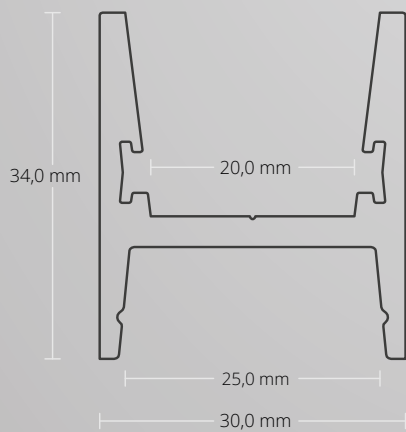

PA1 OUTDOOR

We manufacture the individual lighting system according to your specifications! P. 410
Wir fertigen nach Ihren Vorgaben das individuelle Lichtsystem! S. 412

IP67 | passable/befahrbar | 30 mm x 34 mm

100 cm
8106501

600 cm
8106503

FLUSH-MOUNT | MONTAGESCHIENE

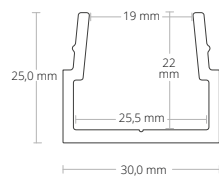

MR1 Aluminium anodized | Aluminium eloxiert
30 mm x 25 mm
100cm
8106560

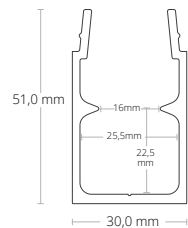

MR2 Aluminium anodized | Aluminium eloxiert
30 mm x 51,0 mm
100cm
8106530

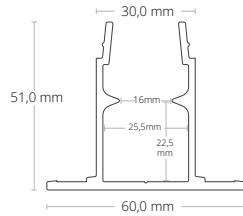

MR3 Aluminium anodized | Aluminium eloxiert
60 mm x 51,0 mm
100cm
8106540





GALAXY[®] profiles

Track System
Schienensysteme

GP20

3-PHASE TRACK RAIL
| 3-PHASEN SCHIENEN

200 cm | 300 cm

OEM



CUSTOMISED ASSEMBLY
INDIVIDUELLE MONTAGE

MECHANICAL PROTECTION
MECHANISCHER SCHUTZ

FLEXIBLE LIGHTING CONTROL
FLEXIBLE LICHTSTEUERUNG

ENERGY EFFICIENT
ENERGIEEFFIZIENT

- Wall, ceiling or floor mounting
Wand-, Decken- oder Bodenmontage
- Living spaces | Wohnräume
- Offices | Büroräume
- Hotel and gastronomy business
Hotellerie und Gastronomie
- Retail (shop and showcase windows)
Einzelhandel (Shop- und Schaufenster)
- Business areas and showrooms
Geschäftsflächen und Showrooms
- Barber / Beauty / body art studios
Friseur-/Beauty-/Body-Art-Studios
- Halls, foyers and corridors
Hallen, Foyers und Flure
- Museums | Museen
- Churches | Kirchen
- Public Spaces | Öffentliche Orte
- Event and seminar rooms
Veranstaltungs- und Seminarräume

Mounting/installation on/in wood Strips and plates, plasterboard, tiles, stone, granite, marble and metal surfaces
Montage/Einbau auf/in Holzleisten und -platten, Gipsplatten, Fliesen, Stein-, Granit-, Marmor- und Metalloberflächen



GP20

3-PHASE TRACK RAIL | 3-PHASEN SCHIENEN

□ RAL 9010 White/Weiß
POWDER-COATED | PULVERBESCHICHTET

■ RAL 9005 Black/Schwarz
POWDER-COATED | PULVERBESCHICHTET

The GP20 3-phase track system is a powerful and innovative lighting solution. The track can be installed as a surface-mounted track or suspended from the ceiling. Thanks to a variety of different connectors, even more complex lighting plans can be easily realised.

The GP20 3-phase track system is ideal for customised lighting solutions tailored to the room. You are free to decide which light source is required. From linear luminaires to spotlights, everything is included. With the 3-phase track system, there are virtually no limits to the lighting concept. You can choose between a discreet, simple black or a modern, clean white colour. There is also a choice of different infeeds, connectors and accessories for customised combinations.

Eine leistungsstarke und innovative Beleuchtungslösung stellt das GP20 3 Phasen Schienensystem dar. Die Schiene kann sowohl als Aufbauschiene montiert oder auch von der Decke abgehängt werden. Dank einer Vielzahl verschiedener Verbinder können auch komplexere Lichtpläne problemlos zur Wirklichkeit werden.

Das GP20 3 Phasen Schienensystem bietet sich für individuelle und auf den Raum abgestimmte Lichtlösungen an. Welche Lichtquelle benötigt wird kann frei entschieden werden. Von Linearleuchte bis Strahler ist alles dabei. Mit dem 3 Phasen Schienensystem sind dem Beleuchtungskonzept kaum Grenzen gesetzt. Zur Farbauswahl stehen ein dezentes, schlichtes Schwarz oder ein modernes, sauberes Weiß. Zur Auswahl stehen auch verschiedene Einspeisungen, Verbinder und Zubehör für eine individuelle Zusammenstellung.



GP20

CONDUCTOR RAIL STROMSCHIENE

2 METRE | METER

8001624

8001623

3 METRE | METER

8001638

8001637

Manufacturer 3-phase conductor rails Hersteller 3-Phasen Stromschienen	Hersteller von kompatiblen Strahlern oder Adaptern Manufacturer of compatible spotlights or adapters							
	Global Trac	Erco	Eutrac	iGuzzini	Hoffmeister	Lumiance	Nordic Aluminium	Zumtobel
Galaxy profiles GP20	✓	✓	✓	✓	✓	✓	✓	✓



ZP07



EINSPEISUNG
LINKS
INFEEED
LEFT

8001622

8001621

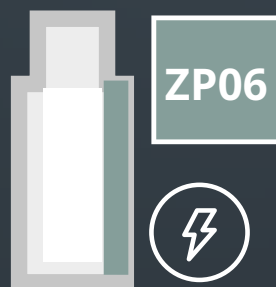

ZP06



EINSPEISUNG
RECHTS
INFEEED
RIGHT

8001620

8001619

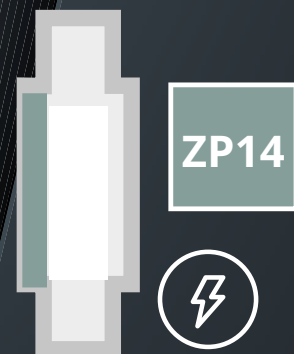

ZP14



EINSPEISUNG
MITTIG
INFEEED
CENTER

8001636

8001635

VERBINDER | CONNECTOR

GALAXY profiles
Perfect Light Lines



ZP03

LINEAR-VERBINDER
POWERING

LINEAR-CONNECTOR
POWERING

- 8001614
- 8001613



ZP04

L-VERBINDER
OUTSIDE

L-CONNECTOR
OUTSIDE

- 8001616
- 8001615



ZP05

L-VERBINDER
INNEN

L-CONNECTOR
INSIDE

- 8001618
- 8001617

T-VERBINDER
RECHTS
T-CONNECTOR
RIGHT



ZP09

- 8001626
- 8001625

T-VERBINDER
LINKS
T-CONNECTOR
LEFT



ZP10

- 8001628
- 8001627

VERBINDER
FLEX
CONNECTOR
FLEX

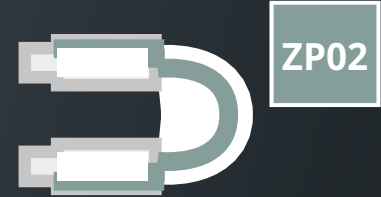

ZP02

- 8001612
- 8001611

ZUBEHÖR | ACCESSORIES



ZP01

ENDKAPPE
END CAPE

- 8001610
- 8001609



ZP11

ABHÄNGEKLAMMER
HANGING-CLIP 
Steel | Stahl

- 8001629
- 8001630



ZP12

SEILABHÄNGUNG |
SUPENSION ACCESSORY 
10 - 200 mm
Steel | Stahl

- 8001632
- 8001631



ZP13

SEILABHÄNGUNG |
SUPENSION ACCESSORY 
10 - 200 mm | Steel | Stahl
Deckenbaldachin/Ceiling canopy

- 8001634
- 8001633

DP10

3-PHASE DALI SURFACE-MOUNTED TRACK
3-PHASEN DALI AUFBAUSCHIENE

200 cm | 300 cm

OEM

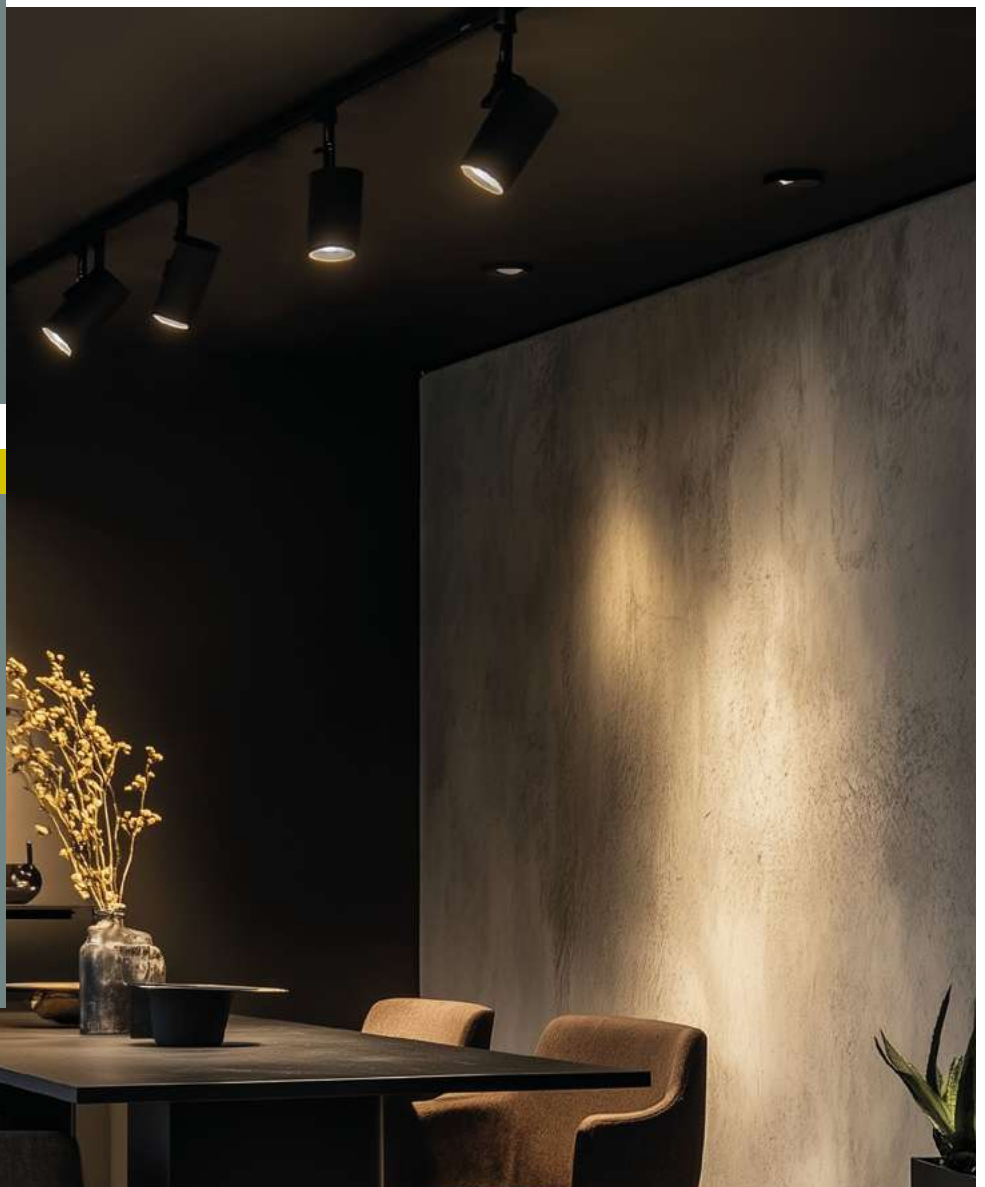

CUSTOMISED ASSEMBLY
INDIVIDUELLE MONTAGE

MECHANICAL PROTECTION
MECHANISCHER SCHUTZ

FLEXIBLE LIGHTING CONTROL
FLEXIBLE LICHTSTEUERUNG

ENERGY EFFICIENT
ENERGIEEFFIZIENT

HOMOGENEOUS LIGHT with modular LED light solutions

- Wall, ceiling or floor mounting
Wand-, Decken- oder Bodenmontage
- Living spaces | Wohnräume
- Offices | Büroräume
- Hotel and gastronomy business
Hotellerie und Gastronomie
- Retail (shop and showcase windows)
Einzelhandel (Shop- und Schaufenster)
- Business areas and showrooms
Geschäftsflächen und Showrooms
- Barber / Beauty / body art studios
Friseur-/Beauty-/Body-Art-Studios
- Halls, foyers and corridors
Hallen, Foyers und Flure
- Museums | Museen
- Churches | Kirchen
- Public Spaces | Öffentliche Orte
- Event and seminar rooms
Veranstaltungs- und Seminarräume

Mounting/installation on/in wood Strips and plates, plasterboard, tiles, stone, granite, marble and metal surfaces
Montage/Einbau auf/in Holzleisten und -platten, Gipsplatten, Fliesen, Stein-, Granit-, Marmor- und Metalloberflächen



DP10

3-PHASE DALI SURFACE-MOUNTED TRACK 3-PHASEN DALI AUFBAUSCHIENE

□ RAL 9010 White/Weiß
POWDER-COATED | PULVERBESCHICHTET

■ RAL 9005 Black/Schwarz
POWDER-COATED | PULVERBESCHICHTET

The DP10 3-phase DALI track system is a modern and versatile solution for professional lighting concepts. It can be mounted directly on the ceiling or suspended, allowing it to be flexibly integrated into different room architectures. Thanks to a wide selection of DALI-compatible connectors, power supplies and accessories, even demanding lighting designs can be implemented with precision.

The DP10 system offers maximum design freedom: whether spotlights, linear lighting or other DALI-compatible luminaires – all variants can be individually combined and controlled individually or in groups via the DALI protocol. This allows lighting moods to be specifically adjusted and dynamic scenarios to be realised.

The track is available in classic black or timeless white and can be supplemented with a variety of connectors and power supplies to create a lighting system that is perfectly tailored to the room.

Das DP10 3-Phasen-DALI-Schienensystem ist eine moderne und vielseitige Lösung für professionelle Beleuchtungskonzepte. Es lässt sich wahlweise direkt an der Decke montieren oder abhängen, wodurch es sich flexibel in unterschiedliche Raumarchitekturen integrieren lässt. Dank einer breiten Auswahl an DALI-fähigen Verbindern, Einspeisungen und Zubehör können selbst anspruchsvolle Lichtplanungen präzise umgesetzt werden.

Mit dem DP10-System entsteht maximale Gestaltungsfreiheit: Ob Strahler, Linearbeleuchtung oder andere DALI-kompatible Leuchten – alle Varianten lassen sich individuell kombinieren und über das DALI-Protokoll einzeln oder gruppenweise steuern. So können Lichtstimmungen gezielt angepasst und dynamische Szenarien realisiert werden.

Erhältlich ist die Schiene in klassischem Schwarz oder zeitlosem Weiß und kann mit einer Vielzahl an Verbindern und Einspeisungen ergänzt werden, um ein perfekt auf den Raum abgestimmtes Beleuchtungssystem zu schaffen.

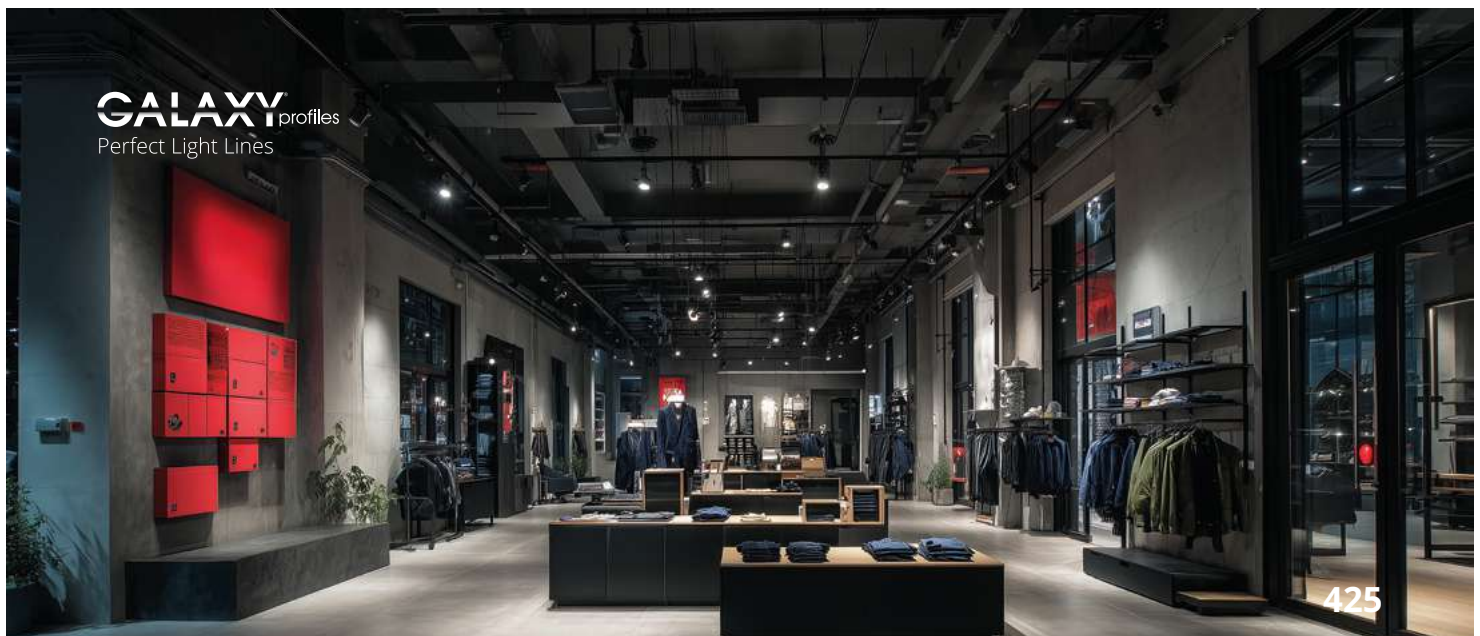



DP10

DP10

3-phase DALI surface-mounted track
3-Phasen DALI Aufbauschiene

200cm **8001639** **8001640**
300cm **8001641** **8001642**

DALI SURFACE-MOUNTED TRACK ACCESSORIES DALI AUFBAUSCHIENEN ZUBEHÖR



ZP12

N-Leiter links | N-conductor left

8001643
 8001645



ZP13

N-Leiter rechts | N-conductor right

8001644
 8001646



ZP14

End cap | Endkappe

8001647
 8001648



ZP15

Linear connector, powering
Linearverbinder, stromführend

8001649
 8001650



ZP16

Centre infeed | Mittel-Einspeisung

8001651
 8001652



ZP17

L-connector, N-conductor inside
L-Verbinder, N-Leiter innen

8001653
 8001655



ZP18

L-connector, N-conductor outside
L-Verbinder, N-Leiter außen

8001654
 8001656



ZP19

T-connector, N-conductor left
T-Verbinder, N-Leiter links

8001657
 8001659

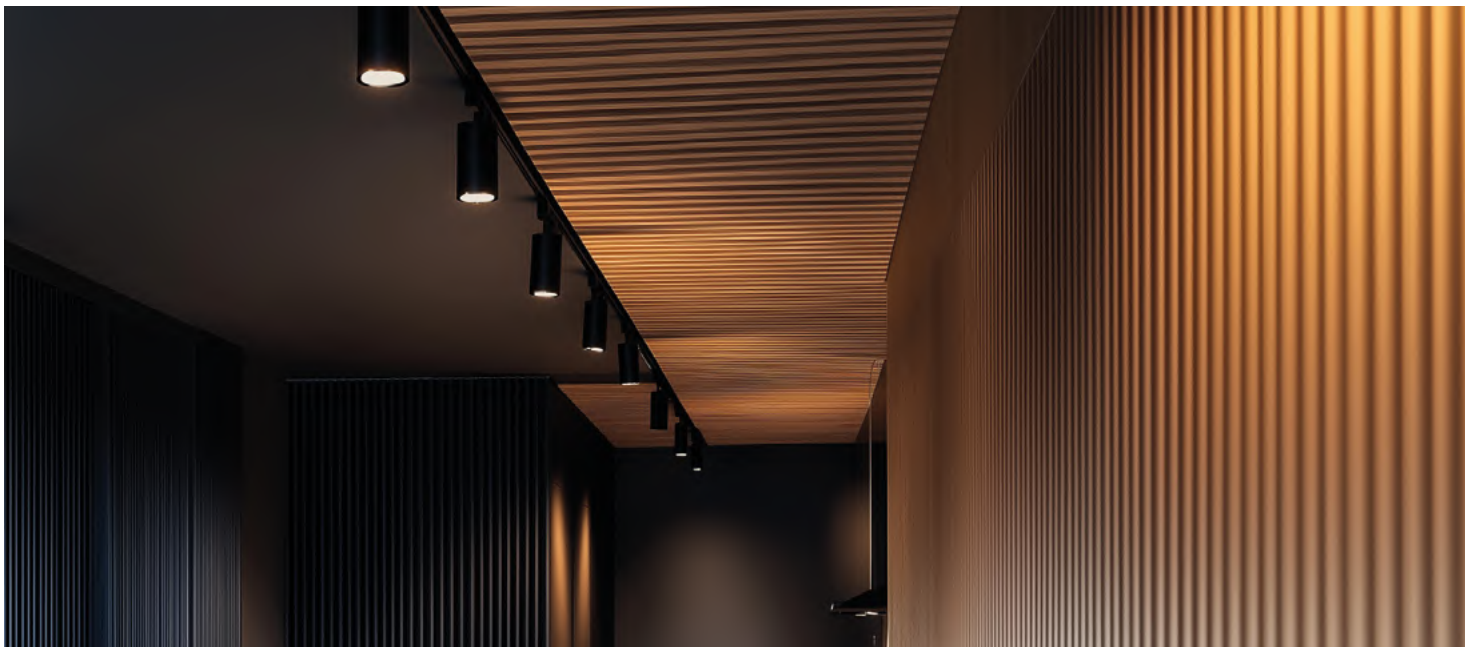

ZP20

T-connector, N-conductor right
T-Verbinder, N-Leiter rechts

■ 8001658
■ 8001660



ZP21

X-connector | X-Verbinder

■ 8001661
■ 8001662



ZP22

Flex-connector | Flex-verbinder

■ 8001663
■ 8001664



ZP23

Rail mounting clip, 1 pc.
Schiene Montageclip, 1 Stk.
Steel | Stahl

■ 8001667 
■ 8001666



ZP24

Hanging Wire System with counterpart
incl. canopy & steel cable, 1 pc.
Seilabh. mit Gegenstück
inkl. Baldachin & Stahlseil, 1 Stk.
Steel | Stahl

■ 8001665 
■ 8001668



ZP25

Mechanical connector
Mechanischer Verbinder
Steel | Stahl

■ 8001669 
■ 8001670



ZP36

Universal adapter | Universaladapter

■ 8001693
■ 8001692



ZP37

Blind cover | Blindabdeckung

■ 8001694
■ 8001695

T48/20

48V TRACK SYSTEM
48V SCHIENENSYSTEM

200 cm | 300 cm

 OEM



NEW TO OUR RANGE
IM SORTIMENT



CUSTOMISED ASSEMBLY
INDIVIDUELLE MONTAGE

MECHANICAL PROTECTION
MECHANISCHER SCHUTZ

FLEXIBLE LIGHTING CONTROL
FLEXIBLE LICHTSTEUERUNG

ENERGY EFFICIENT
ENERGIEEFFIZIENT

HOMOGENEOUS LIGHT with modular LED light solutions

- Wall, ceiling or floor mounting
Wand-, Decken- oder Bodenmontage
- Living spaces | Wohnräume
- Offices | Büroräume
- Hotel and gastronomy business
Hotellerie und Gastronomie
- Retail (shop and showcase windows)
Einzelhandel (Shop- und Schaufenster)
- Business areas and showrooms
Geschäftsflächen und Showrooms
- Barber / Beauty / body art studios
Friseur-/Beauty-/Body-Art-Studios
- Halls, foyers and corridors
Hallen, Foyers und Flure
- Museums | Museen
- Churches | Kirchen
- Public Spaces | Öffentliche Orte
- Event and seminar rooms
Veranstaltungs- und Seminarräume

Mounting/installation on/in wood Strips and plates, plasterboard, tiles, stone, granite, marble and metal surfaces
Montage/Einbau auf/in Holzleisten und -platten, Gipsplatten, Fliesen, Stein-, Granit-, Marmor- und Metalloberflächen



T48/20

48V TRACK SYSTEM

48V SCHIENENSYSTEM

□ RAL 9010 White/Weiß
POWDER-COATED | PULVERBESCHICHTET

■ RAL 9005 Black/Schwarz
POWDER-COATED | PULVERBESCHICHTET

The 48V track system combines modern design, high efficiency and maximum flexibility in a compact and discreet system. The low-voltage technology ensures maximum safety and enables the use of particularly delicate LED luminaires. Whether magnetic spotlights, linear lighting or pendant luminaires – thanks to the magnetic adapter system, the luminaires can be easily inserted, exchanged or repositioned.

The system offers four different rail variants: the classic TS1 surface-mounted track, the slim TS2 surface-mounted track flat, the TS3 drywall track and the TS4 installation track. Each track can be flexibly combined with various accessories, connectors and power supply systems, so that even complex lighting concepts can be easily realised.

The T48/20 system is ideal for living spaces, offices, shops or galleries where design and functionality are equally important. It is available in classic black or modern white, allowing it to be individually adapted to any room concept.

Das 48V Schienensystem vereint modernes Design, hohe Effizienz und maximale Flexibilität in einem kompakten und dezenten System. Die Niedervolt-Technologie sorgt für höchste Sicherheit und ermöglicht den Einsatz besonders filigraner LED-Leuchten. Ob magnetische Strahler, Linearbeleuchtungen oder Pendelleuchten – dank des magnetischen Adaptersystems lassen sich die Leuchten einfach einsetzen, austauschen oder neu positionieren.

Das System bietet vier verschiedene Schienenvarianten: die klassische Aufbauschiene TS1, die schlanke Aufbauschiene Flat TS2, die Trockenbauschiene TS3 sowie die Einbauschiene TS4. Jede Schiene kann flexibel mit verschiedenem Zubehör, Verbinder- und Einspeisungssystemen kombiniert werden, sodass sich selbst komplexe Lichtkonzepte problemlos realisieren lassen.

Ideal geeignet ist das T48/20-System für Wohnräume, Büros, Shops oder Galerien, in denen Design und Funktionalität gleichermaßen zählen. Erhältlich ist es in klassischem Schwarz oder modernem Weiß, wodurch es sich individuell an jedes Raumkonzept anpassen lässt.





NEW TO OUR RANGE
IM SORTIMENT

Versatility meets elegance: the T48/20 magnetic track system

Realise stylish and flexible lighting concepts with our T48/20 tracks. The recessed tracks can be mounted seamlessly flush with the ceiling, while the surface-mounted and pendant tracks create special accents. Discover the entire range with matching accessories for customised lighting solutions!

Vielseitigkeit trifft Eleganz:

Das T48/20 Magnetschienensystem

Verwirklichen Sie stilvolle und flexible Lichtkonzepte mit unseren T48/20 Schienen. Die Einbauschielen lassen sich nahtlos deckenbündig montieren, während die Aufbau- und Pendelschielen besondere Akzente setzen. Entdecken Sie die gesamte Serie mit passendem Zubehör für maßgeschneiderte Beleuchtungslösungen!



TS1

SURFACE MOUNTED TRACK
AUFBAUSCHIENE



TS2

SURFACE MOUNTED TRACK FLAT
AUFBAUSCHIENE FLAT



TS3

DRYWALL TRACK
TROCKENBAUSCHIENE



TS4

INSTALLATION TRACK
EINBAUSCHIENE

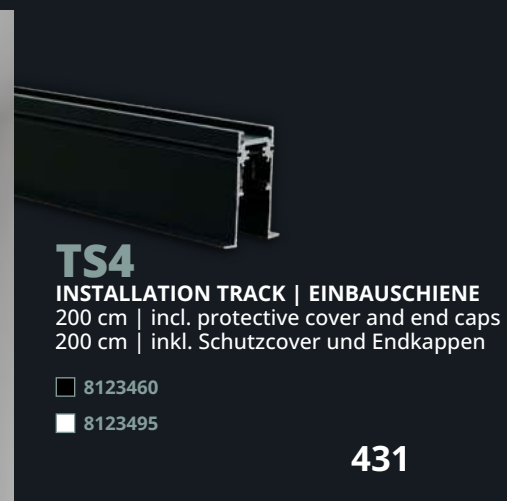
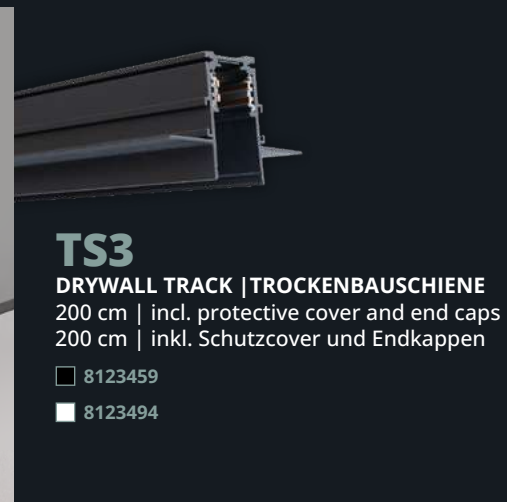
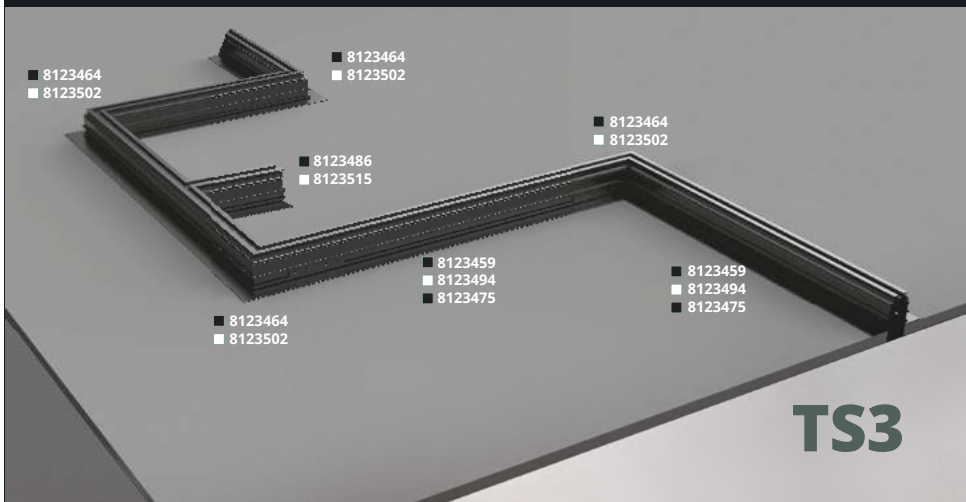
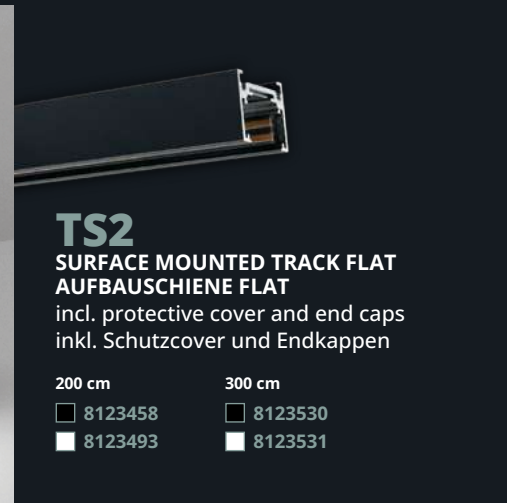
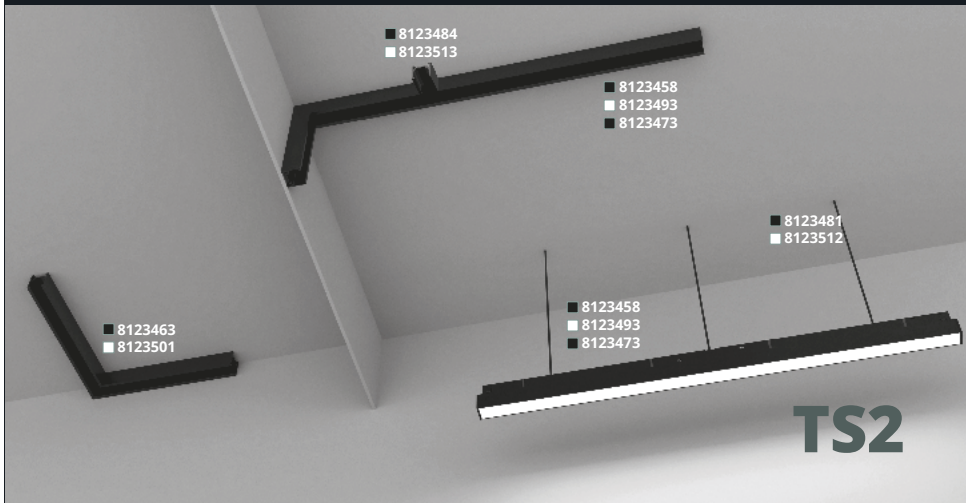
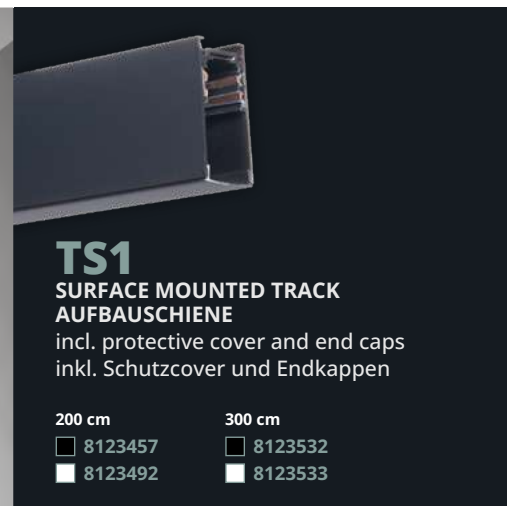
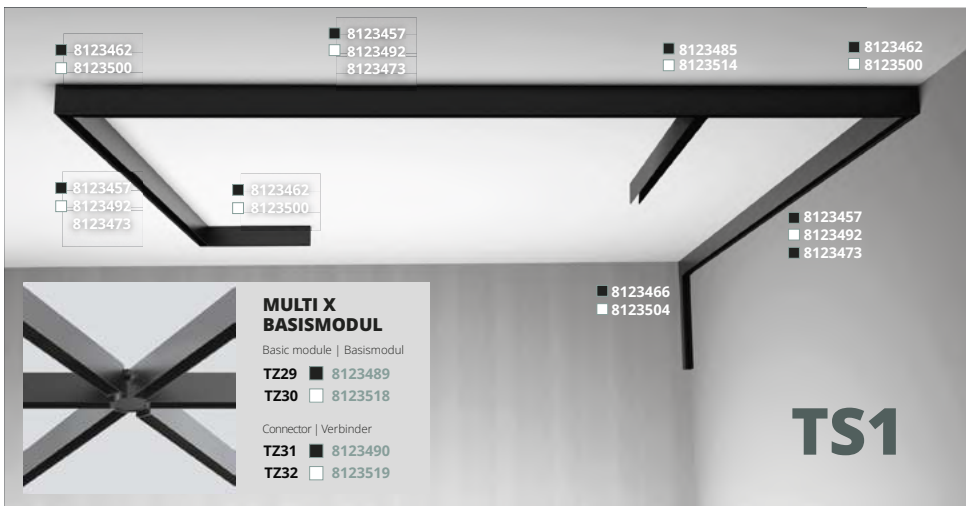

OVERVIEW OF COVERS WITH LED FLEX STRIPS COVERS MIT LED FLEXBAND IM ÜBERBLICK

PROTECTIVE COVER
White
No light transmission

PROTECTIVE COVER
Black
No light transmission

COVER
White
75%

COVER
Black
25%

WITHOUT COVER

SCHUTZCOVER
Weiß
Keine
Lichtdurchlässigkeit

SCHUTZCOVER
Schwarz
Keine
Lichtdurchlässigkeit

ABDECKUNG
Weiß
75%

ABDECKUNG
Schwarz
25%

OHNE ABDECKUNG

NEW

SOUND ON TRACK | KLANG AUF SCHIENE

LIMITLESS, TIMELESS, EFFORTLESS. | GRENZENLOS, ZEITLOS, MÜHELOS.

BLUETOOTH MESH | BLUETOOTH-NETZWERK

Power | Leistung: 10 W
Voltage | Spannung: 48V
Bluetooth Distance | Bluetooth Distanz: 10 m
Distance between transmitter and receiver |
Distanz zwischen Sender und Empfänger: 20 m
Protection class | Schutzart: IP20

8123606

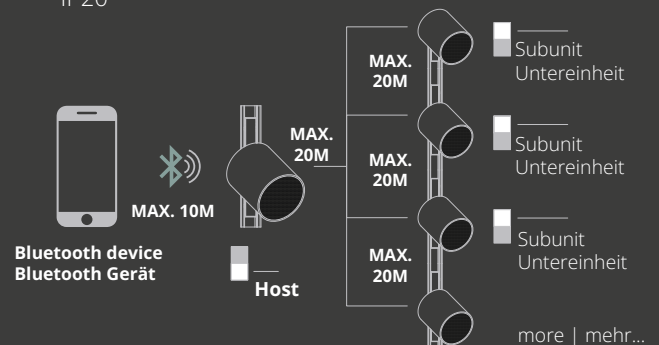
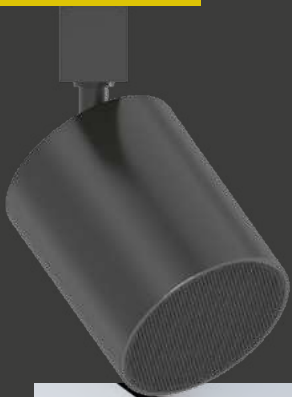

ACCESSORIES SUITABLE FOR ALL TRACKS ZUBEHÖR FÜR ALLE SCHIENEN GEEIGNET

GALAXY profiles
Perfect Light Lines

Power infeed
Stromeinspeisung



50cm **TZ53** ● 8123469
TZ38 ● 8123506
2m **TZ35** ● 8123470
TZ37 ● 8123507

Power infeed/power output
Stromein- & ausspeiser



TZ39 ● 8123524
TZ40 ● 8123525

Inline transformer flat 100W
Inline-Trafo flat 100W



TZ15 ● 8123482
TZ16 ● 8123521

Inline transformer 150W
Inline-Trafo 150W



TZ17 ● 8123483
TZ18 ● 8123522

Linear connector 180° flexible
Linear-Verbinder 180° flexibel



TZ19 ● 8123471
TZ20 ● 8123508

Linear connector 45° flexible
Linear-Verbinder 45° flexibel



TZ21 ● 8123472
TZ22 ● 8123509

Linear connector mini
Linear-Verbinder mini



TZ23 ● 8123491
TZ24 ● 8123510

T-connector flexible
T-Verbinder flexibel



TZ49 ● 8123488
TZ50 ● 8123517

TZ54

Cable Sleeve
Kabelhülse



● 8123523





TS1
SURFACE MOUNTED TRACK
AUFBAUSCHIENE

incl. protective cover and end caps
inkl. Schutzcover und Endkappen

200 cm

- 8123457
- 8123492

300 cm

- 8123532
- 8123533

TS1 accessories | TS1 Zubehör

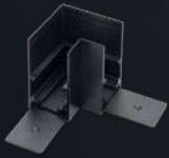

Corner track 90° horizontal,
non-current-carrying
Eckschiene 90° horizontal,
nicht stromführend

- TZ01** 8123462
- TZ04** 8123500



Corner track 90° vertical,
non-current-carrying
Eckschiene 90° vertikal,
nicht stromführend

- TZ08** 8123466
- TZ11** 8123504



T-track horizontal,
non-current-carrying
T-Schiene horizontal,
nicht stromführend

- TZ41** 8123485
- TZ44** 8123514



SC1
Cover | Abdeckung
2m

- 8123449 25%
- 8123450 75%



Multi x base module
Multi X Basismodul

- TZ29** 8123489
- TZ30** 8123518



Multi X connector
for base module
Multi X Verbinder
zum Basismodul

- TZ31** 8123490
- TZ32** 8123519



TZ52
Connection plate, 1 pcs.
Verbindungsplatte, 1 stk.

- 8123473



Mounting clip, 2 pcs.
Montageclip, 2 stk.

- TZ25** 8123474
- TZ26** 8123511

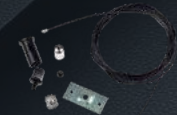

Cable suspension 2m, 2 pcs.
Seilabhängung 2m, 2 stk.

- TZ33** 8123481
- TZ34** 8123512

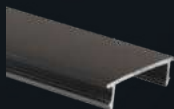

TZ36
Blind cover
Blindabdeckung

- 2m 8123534
- 2m 8123536
- 3m 8123535
- 3m 8123537



TZ55
Connection plate, 1 pcs.
Verbindungsplatte, 1 stk.

- 8192346

END CAPS | ENDKAPPEN

2 pcs. | 2 stk.

External end cap for cover |
Aussenanliegende Endkappe für Cover

- TE17** 8123528
- TE18** 8123527

Internal end cap for cover |
innenliegende Endkappe für Cover

- TE13** 8123526
- TE14** 8123453

Endcaps without cover | Endkappen ohne Cover

- TE01** 8123476
- TE05** 8123497



TS2 SURFACE MOUNTED TRACK FLAT AUFBAUSCHIENE FLAT

incl. protective cover and end caps
inkl. Schutzcover und Endkappen

200 cm

□ 8123458

■ 8123493

300 cm

□ 8123530

■ 8123531

GALAXY profiles
Perfect Light Lines

TS2 accessories | TS2 Zubehör

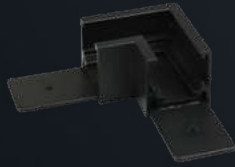

Corner track 90° horizontal,
non-current-carrying
Eckschiene 90° horizontal,
nicht stromführend

TZ14 ○ 8123463

TZ05 ● 8123501



T-track horizontal,
non-current-carrying
T-Schiene horizontal,
nicht stromführend

TZ42 ○ 8123484

TZ45 ● 8123513



TZ52

Connection plate, 1 pcs.
Verbindungsplatte, 1 stk.

○ 8123473



Mounting clip, 2 pcs.
Montageclip, 2 stk.

TZ25 ○ 8123474

TZ26 ● 8123511

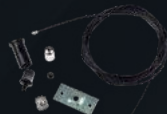

Cable suspension 2m, 2 pcs.
Seilabhängung 2m, 2 stk.

TZ33 ○ 8123481

TZ34 ● 8123512



SC2

Cover | Abdeckung
2m

○ 8123451 25%

● 8123452 75%



TZ55

Connection plate, 1 pcs.
Verbindungsplatte, 1 stk.

○ 8192346

END CAPS | ENDKAPPEN

2 pcs. | 2 stk.

EXTERNAL END CAP FOR SC2 | 2 PCS.

AUSSENANLIEGENDE ENDKAPPE FÜR SC2 | 2 STK.

TE09 ● 8123596

TE10 ○ 8123597

INTERNAL END CAP FOR SC2 | 2 PCS.

INNENANLIEGENDE ENDKAPPE FÜR SC2 | 2 STK.

TE11 ● 8123594

TE12 ○ 8123595

EXTERNAL END CAP WITHOUT COVER | 2 PCS.

AUSSENANLIEGENDE ENDKAPPE OHNE COVER | 2 STK.

TE02 ● 8123477

TE06 ○ 8123496

INTERNAL END CAP FOR SC1 | 2 PCS.

INNENLIEGENDE ENDKAPPE FÜR SC1 | 2 STK.

TE19 ● 8123529

TE20 ○ 8123454

EXTERNAL END CAP FOR SC1 | 2 PCS.

AUSSENANLIEGENDE ENDKAPPE FÜR SC1 | 2 STK.

TE15 ● 8123455

TE16 ○ 8123456



TS3

DRYWALL TRACK | TROCKENBAUSCHIENE

200 cm | incl. protective cover and end caps

200 cm | inkl. Schutzcover und Endkappen

□ 8123459

■ 8123494

TS3 accessories | TS3 Zubehör

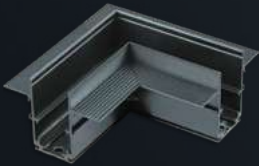

Corner track 90° horizontal,
non-current-carrying
Eckschiene 90° horizontal,
nicht stromführend

TZ02 ○ 8123464

TZ06 ● 8123502



Corner track 90° vertical,
non-current-carrying
Eckschiene 90° vertikal,
nicht stromführend

TZ09 ○ 8123467

TZ12 ● 8123520

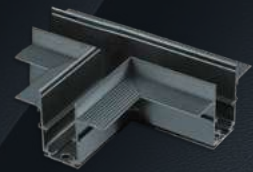

T-track horizontal,
non-current-carrying
T-Schiene horizontal,
nicht stromführend

TZ43 ○ 8123486

TZ46 ● 8123515



TZ51

Connection plate, 2 pcs.
Verbindungsplatte, 2 stk.

● 8123475



SC1

Cover | Abdeckung
2m

○ 8123449 25%

● 8123450 75%



TZ36

Blind cover
Blindabdeckung

2m ○ 8123534

● 8123536

3m ○ 8123535

● 8123537

EXTERNAL END CAP | AUSSENANLIEGENDE ENDKAPPE

TE03 ● 8123479

TE07 ○ 8123499

436

INTERNAL END CAP | INNENLIEGENDE ENDKAPPE

TE13 ● 8123526

TE14 ○ 8123453





TS4

INSTALLATION TRACK | EINBAUSCHIENE
 200 cm | incl. protective cover and end caps
 200 cm | inkl. Schutzcover und Endkappen

- 8123460
- 8123495

GALAXY profiles
 Perfect Light Lines

TS4 accessories | TS4 Zubehör

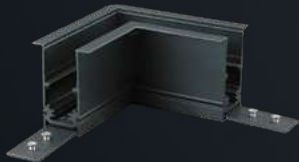

Corner track 90° horizontal,
 non-current-carrying
 Eckschiene 90° horizontal,
 nicht stromführend

- TZ03 8123465
- TZ07 8123503



Corner track 90° vertical,
 non-current-carrying
 Eckschiene 90° vertikal,
 nicht stromführend

- TZ10 8123468
- TZ13 8123505

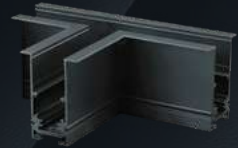

T-track horizontal,
 non-current-carrying
 T-Schiene horizontal,
 nicht stromführend

- TZ47 8123487
- TZ48 8123516



TZ52
 Connection plate, 1 pcs.
 Verbindungsplatte, 1 stk.

- 8123473



SC1
 Cover | Abdeckung
 2m

- 8123449
- 8123450



TZ28
 Mounting clip 2 pcs.
 Montageklammer 2 stk.

- 8123480



TZ27
 Mounting spring 2 pcs.
 Montagefeder 2 stk.

- 8123461



TZ36
 Blind cover
 Blindabdeckung

- 2m 8123534
- 8123536
- 3m 8123535
- 8123537



TZ55
 Connection plate, 1 pcs.
 Verbindungsplatte, 1 stk.

- 8192346

EXTERNAL END CAP | AUSSENANLIEGENDE ENDKAPPE

- TE04 8123478
- TE08 8123498

INTERNAL END CAP | INNENLIEGENDE ENDKAPPE

- TE13 8123526
- TE14 8123453







GALAXY[®] profiles

Accessories

Zubehör

ACCESSORIES | ZUBEHÖR

Technical data sheet on www.galaxy-profiles.com
Technische Datenblätter auf www.galaxy-profiles.com

Cleaning | Degreasing
Reinigung | Entfettung



SEAL AND BOND REMOVER

8001270 Item No. | Art. Nr.
Seal and Bond Remover 500 ml (Aerosol)

Seal and bond remover is an especially high-quality technical cleaning product for removing adhesive residue, softening and removing various adhesive and sealing gums and degreasing various surfaces. The product softens most adhesives and sealants, making them easier to remove.

- Cleans and degreases the base material before using sealant and adhesive!
- Very effective! Also for tar splashes, resin, wax residue
- Evaporates quickly with no residue!
- Does not affect varnish, glass, aluminium, rubber or most plastics!
- Ideal for removing adhesive, sealant and chewing gum residue!
- Very easy to use!

Seal and Bond Remover ist ein technisch besonders hochwertiges Reinigungsprodukt zum Entfernen von Kleberückständen, zum Lösen und Weichmachen verschiedener Dicht- und Klebe-Massen, sowie zum Entfetten verschiedenster Oberflächen. Das Produkt weicht die meisten Kleber und Dichtmassen auf, um sie leichter entfernen zu können.

- Reinigt und entfettet den Untergrund vor Abdichtungs- und Verklebungsarbeiten!
- Hohes Auflösungsvermögen! Auch für Teerspritzer, Baumharz, Wachsrückstände
- Schnelle und rückstandsfreie Ablüftung!
- Greift Lack, Glas, Alu, Gummi und die meisten Kunststoffe in keinsten Weise an!
- Ideal zum Entfernen von Klebstoff-, Dichtmassen- und Kaugummiresten!
- Sehr einfach in der Handhabung!

Mounting Adhesive/Adhesive Tape/ Protective Materials

Montagekleber/Klebebänder/Schutzmaterial



POWERBOND XS 330

8001450 Item No. | Art. Nr.

Powerbond XS 330 white/weiß (0100) | 290 ml Cartridge/Kartusche

8001451 Item No. | Art. Nr.

Powerbond XS 330 black/schwarz (0000) | 290 ml Cartridge/Kartusche

Powerbond XS 330 is a high-quality mounting adhesive based on the latest generation of MS polymers. Thanks to its extremely high bonding power, this product makes any mounting work easier and faster.

- For inside and out - on almost any (even slightly damp) surfaces!
- Extremely high initial adherence - does not rip or shrink!
- Long-lasting elasticity, very flexible! Fracture strain: 330%
- No solvents, hazardous softeners or isocyanates!
- Low viscosity, so very easy to work with!
- Temperature-resistant from -40°C to +100°C

Powerbond XS 330 ist ein hochwertiger Montagekleber auf Basis der neuesten Generation von MS-Polymeren. Aufgrund seiner extrem hohen Anfangshaftung macht dieses Produkt Montagearbeiten einfacher und schneller.

- Für Innen und Außen - auf nahezu allen (sogar leicht feuchten) Untergründen!
- Extrem hohe Anfangshaftung - Schrumpft und reißt nicht!
- Dauerelastisch, hohe Flexibilität! Bruchdehnung: 330 %
- Ohne Lösungsmittel, schädliche Weichmacher und Isocyanate!
- Niedrige Viskosität, dadurch sehr leicht zu verarbeiten!
- Temperaturbeständig von -40°C bis +100°C!

UNIFIX 300 S

8001536 Item No. | Art. Nr.

Unifix 300 s white/weiß (0100) | 50 ml double cartridge/Doppelkartuschen

Unifix 300 s is a fast-drying, slightly expanding 2K liquid wall plug suitable for various mounting jobs in construction and maintenance (e.g. worn-out drill holes). Thanks to excellent, fast adherence, this product makes any mounting job significantly easier.

- Good adhesion on all building materials!
- Perfect fixation thanks to stable foam effect!
- No solvents or hazardous softeners!
- Use the mesh sleeve for precise dosage into hollow materials!
- Can easily be drilled, sanded and painted!
- Exceptional hold and stability!
- No pressure required - no damage to tiles or plaster!
- Dries fast (approx 5 mins) and hardens fast (approx 10 mins)!

Unifix 300 s ist ein schnell aushärtender und leicht expandierender 2K-Flüssigdübel, der für verschiedenste Montagearbeiten im Bereich Bau und Wartung (z.B. ausgeschlagene Bohrlöcher uvm.) geeignet ist. Aufgrund seiner schnellen und hervorragenden Haftung macht dieses Produkt Montagearbeiten erheblich einfacher.

- Gute Haftung auf sämtlichen Baumaterialien!
- Perfekte Fixierung dank stabiler Schaumwirkung!
- Ohne Lösungsmittel und schädliche Weichmacher!
- Genaue Dosierung in hohlen Materialien bei Verwendung der Siebhülse!
- Lässt sich sehr gut bohren, schleifen, überstreichen!
- Ausgezeichnete Haltbarkeit und Stabilität!
- Drucklose Verankerung - keine Beschädigung von Fliesen oder Putz!
- Schnelle Trocknung (ca. 5 Min.) und Durchhärtung (ca. 10 Min.)!



CLEAR TRANSFER ADHESIVE



8000166 Item No. | Art. Nr.

Clear Transfer Adhesive Double-Sided Tape/Doppelklebeband | 15 mm | 25 m/Rolle

Clear transfer adhesive is an almost transparent, double-sided adhesive tape for quickly and cleanly creating an adhesive bond in a range of situations.

- Very high adhesive power despite minimal thickness!
- High temperature resistance! -20°C to +150°C
- Even layer of adhesive - optimal adhesion!
- Doesn't discolour or dry out!
- Extra thin adhesive bond! 0.13mm in width
- Can be removed without residue!

Clear Transfer Adhesive ist ein nahezu transparentes, doppelseitiges Klebeband für schnelle und saubere Klebeverbindungen in zahlreichen Anwendungen.

- Trotz minimaler Dicke sehr hohe Klebekraft!
- Hohe Temperaturbeständigkeit! -20°C bis +150°C
- Gleichmässige Klebeschicht – Optimale Haftung!
- Verfärbt nicht - trocknet nicht aus!
- Extradünne Klebeverbindung! 0,13 mm stark
- Rückstandsfrei entfernbar!

MOULDING TAPE



8000161 Item No. | Art. Nr.

Moulding Tape Double-Sided Tape/Doppelklebeband (PU-Foam/Schaum)
6 mm x 0,8 mm | 10 m/Rolle

8000162 Item No. | Art. Nr.

Moulding Tape Double-Sided Tape/Doppelklebeband (PU-Foam/Schaum)
12 mm x 0,8 mm | 10 m/Rolle

8000165 Item No. | Art. Nr.

Moulding Tape Double-Sided Tape/Doppelklebeband (PU-Foam/Schaum)
25 mm x 0,8 mm | 10 m/Rolle

Moulding tape is an especially high-quality, correctable, double-sided adhesive tape based on polyurethane foam - exceptionally suited to many adhesion jobs inside and out.

- Temperature resistant from -40°C to +95°C! And up to +150°C for short periods
- Can be repositioned several times! Within approx 5 minutes
- High tensile and adhesive force! 6.1kg/cm²
- Resistant to water, weak acids and weather effects!
- Retains its elasticity! Fracture strain: 220%
- Absorbs practically no liquid! Closed cell structure

Moulding Tape ist ein besonders hochwertiges, korrigierbares, doppelseitig klebendes Band auf Polyurethan-Schaumbasis - hervorragend geeignet für viele Verklebungen im Innen- und Außenbereich.

- Temperaturbeständig von -40°C bis +95°C! Kurzfristig bis zu +150°C
- Mehrmaliges Neupositionieren möglich! Innerhalb von ca. 5 Minuten
- Hohe Zug- und Haft-Kraft! 6,1 kg/cm²
- Beständig gegen Wasser, schwache Säuren und Witterungseinflüsse!
- Dauerelastisch! Bruchdehnung: 220 %
- Nimmt praktisch keine Feuchtigkeit auf! Geschlossene Zellstruktur

Sealant/Filler/Impregnation Abdichtung/Füllmaterial/Imprägnierung



EASY SEAL XS

8001381 Item No. | Art. Nr.

Easy Seal XS transparent (6090) | 310 ml Cartridge/Kartusche

Easy Seal XS is a unique, neutral hardening, acid-free, solvent-free and oxime-free universal polymer sealant based on odour-neutral alcoxyl polysiloxane for the secure, flexible sealing of various construction and connection joints on a variety of base materials.

- Absolutely harmless to health and odour-neutral!
- Acid-free, solvent-free and oxime-free!
- High UV and temperature resistance! -40°C to +150°C
- 100% colour fastness - no discolouration or yellowing!
- Excellent resistance to water and mould!
- Retains its elasticity! 215% fracture strain

Easy Seal XS ist eine einzigartige, neutral aushärtende, säure-, lösungsmittel- und oximfreie universelle Polymer-Dichtmasse auf Basis geruchsneutraler Alcoxyl-Polysiloxane zum sicheren und dauerhaft elastischen Abdichten diverser Konstruktions- und Anschlussfugen auf verschiedensten Untergründen.

- Absolut gesundheitsunschädlich und geruchsneutral!
- Säure-, lösungsmittel- und oximfrei!
- Hohe UV- und Temperaturbeständigkeit! -40 °C bis +150 °C
- 100 % Farbestabilität - kein Verfärben und Vergilben!
- Ausgezeichnete Wasserbeständigkeit und Schimmelresistenz!
- Dauerelastisch! 215 % Bruchdehnung



ADHESEAL

8000143 Item No. | Art. Nr.

Adheseal white/weiß (0100) | 290ml Cartridge/Kartusche

8001430 Item No. | Art. Nr.

Adheseal black/schwarz (0000) | 290ml Cartridge/Kartusche

Adheseal is a unique, especially high-quality, wet-on-wet paintable, permanently elastic adhesive and sealant based on an MS polymer. Adheseal provides perfect adhesion even on awkward materials!

- Temperature resistant from -40°C to +100°C!
- Very high adhesive power! 26kg/cm²
- Extremely high fracture strain! 400%
- Very good UV resistance!
- Solvent-free and isocyanate-free!
- Impressive long-lasting elasticity!

Adheseal ist eine einzigartige, besonders hochwertige, nass in nass überlackierbare, dauerhaft elastische Klebe- und Dichtmasse auf MS-Polymerbasis. Adheseal bietet selbst auf heiklen Materialien eine einwandfreie Haftung!

- Temperaturbeständig: -40 bis +100 °C!
- Sehr hohes Haftvermögen! 26 kg/cm²
- Extrem hohe Bruchdehnung! 400 %
- Sehr gute UV-Beständigkeit!
- Lösungsmittel- und Isocyanatfrei!
- Beeindruckende, dauerhafte Elastizität!



SEAL FLUID

8001274 Item No. | Art. Nr.
Seal Fluid | 500ml Spray Bottle/Sprühflasche

Seal Fluid is a special solution for smoothing humidity-hardening sealants such as Innotec Easy Seal XS (universal polymer sealant). Thanks to its mild formula, Seal Fluid can be used on almost all surfaces.

- Especially mild special formula!
- Can be used on almost any surface!
- Solvent-free!
- Ready to use!
- Ideal for smoothing various sealants! Easy Seal XS, Adheseal, Safe Seal IQ

Seal Fluid ist eine Speziallösung zum Ausglätten von luftfeuchtigkeitshärtenden Dichtmassen wie z.B. Innotec Easy Seal XS (Universelle Polymer-Dichtmasse). Dank seiner milden Zusammensetzung ist Seal Fluid auf fast allen Flächen sicher anwendbar.

- Besonders milde Spezial-Formel!
- Auf nahezu jedem Untergrund anwendbar!
- Lösungsmittelfrei!
- Gebrauchsfertig!
- Ideal zum Ausglätten verschiedenster Dichtmassen! Easy Seal XS, Adheseal, Safe Seal IQ



ELECTRO SEAL

8001440 Item No. | Art. Nr.
Electro Seal 3 x 15 ml Tubes/Packs | Tuben/Packung

Electro Seal is a unique, blue liquid sealant based on polymer rubber for the optimal insulation and protection of electrical components such as wires, plugs, sensors etc. Electro Seal is easy to apply precisely, even in hard-to-reach places.

- Easy to apply very precisely!
- Once fully dry (touch-dry after 10 mins), flexible and vibration-resistant!
- Very high dielectric strength! (40,000 V/mm)
- Excellent stability!
- Excellent moisture resistance!
- High temperature resistance! (-35°C to +120°C)

Electro Seal ist eine einzigartige blaue Flüssigdichtung auf Polymer-Kautschuk Basis zum optimalen Isolieren und Schützen von elektrischen Komponenten, wie Verdrahtungen, Stecker, Sensoren etc. Electro Seal ist einfach und sehr präzise anzubringen, sogar an schwer zugänglichen Stellen.

- Einfach und sehr präzise anzubringen!
- Nach Durchtrocknung (griff trocken nach 10 Min.) flexibel und vibrationsfest!
- Sehr hohe Durchschlagsfestigkeit! (40.000 V/mm)
- Ausgezeichnetes Standvermögen!
- Ausgezeichnete Feuchtigkeitsbeständigkeit!
- Hohe Temperaturbeständigkeit! (-35°C bis +120°C)



SEAL GUARD PRIMER

8001487 Item No. | Art. Nr.
for critical surfaces, transparent, 250ml | für kritische Oberflächen, transparent, 250ml

Seal Guard is a transparent primer that improves the adhesion of various air-moisture curing adhesives and sealants. The product is particularly suitable for porous materials, but also for use on most other substrates. With an application width of 2.5 cm, Seal Guard is sufficient for approx. 92 linear metres of bonding distance.

- High-quality, adhesion-enhancing primer
- Suitable for continuous use under water
- Practical, resealable can
- Perfect insulator between sealant and possible overpaint
- Solvents in paints do not attack sealant

Seal Guard ist ein transparenter Primer, der die Haftung diverser luftfeuchtigkeitshärtender Klebe- und Dichtmassen verbessert. Das Produkt ist insbesondere auf porösen Materialien, aber auch für die Anwendung auf den meisten anderen Untergründen geeignet. Seal Guard reicht bei einer Auftragsbreite von 2,5 cm für ca. 92 Laufmeter Verklebungsstrecke.

- Hochwertiger, haftungsverbessernder Primer
- Geeignet für Dauernutzung unter Wasser
- Praktische, wiederverschließbare Dose
- Perfekter Isolator zwischen Dichtmasse und eventueller Überlackierung
- Lösungsmittel in Lacke greifen Dichtmasse nicht an

Accessories | Zubehör



EASY GRIP GUN

8001490 Item No. | Art. Nr.

Easy Grip Gun | Cartridges up to 310ml | Kartuschen bis 310ml

This handheld cartridge gun boasts an extra strong transfer of energy and an open slot for up to 310ml.

Die Hand-Kartuschenpistole hat eine extra starke Übersetzung sowie eine offene Aufnahme bis 310 ml.



FLEXBAND-MONTAGEROLLER

8001608 Item No. | Art. Nr.

Flexband mounting roller | Flexband-Montageroller

IP20 flexbands or the surface of the LED chips should not be touched with bare fingers. To press the flexible circuit board onto the cooling substrate use our flex tape mounting roller.

IP20 Flexbänder bzw. die Oberfläche der LED Chips sollte nicht mit blanken Fingern berührt werden. Verwenden Sie zum Andrücken der flexiblen Platine auf dem Kühluntergrund unseren Flexband-Montageroller.



BIT AND RATCHET | BIT UND RATSCHKE

8123433 Item No. | Art. Nr.

Set for installing profile connectors | Set zur Montage von Profilverbindern

Fitting profile connectors made easy! With our handy ratchet and a slim bit, you can tighten profile connectors effortlessly. This ensures a secure hold in no time at all.

Profilverbinder montieren leicht gemacht! Mit unserer handlichen Ratsche und einem schmalen Bit schrauben Sie Profilverbinder mühelos fest. So sorgen Sie im Handumdrehen für einen sicheren Halt.



INDEX BY PROFILE SYSTEMS | NACH PROFILSYSTEMEN

PL S. 38

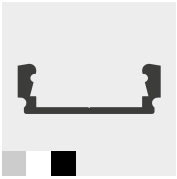

PL1 S. 38
max. 12 mm

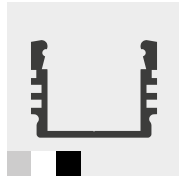

PL2 S. 42
max. 12 mm

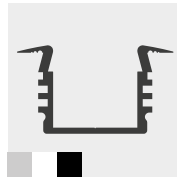

PL3 S. 46
max. 12 mm

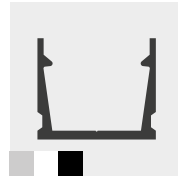

PL4 S. 50
max. 10 mm

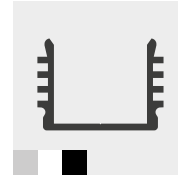

PL5 S. 54
max. 12 mm

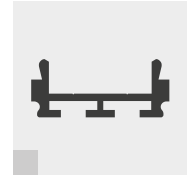

PL6 S. 60
max. 12 mm

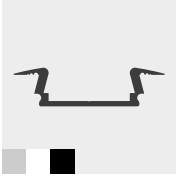

PL8 S. 66
max. 12 mm

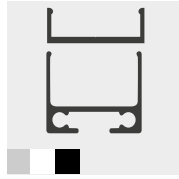

PL10 S. 70



PL11 S. 76
max. 12 mm

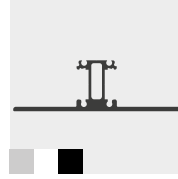

PL13 S. 80
max. 12 mm

PO S. 84

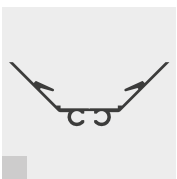

PO5 S. 84
max. 12 mm

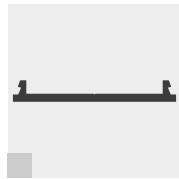

PO13 S. 88
max. 15 mm



PO14 S. 92
max. 12 mm

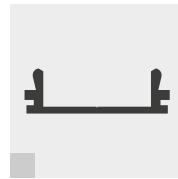

PO15 S. 96
max. 12 mm

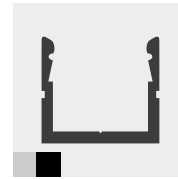

PO16 S. 100
max. 8 mm

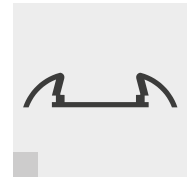

PO17 S. 104
max. 11 mm

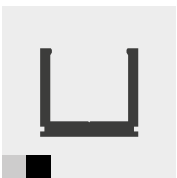

PO18 S. 108
max. 6 mm

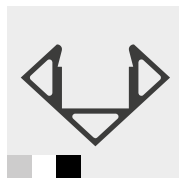

PO23 S. 112
max. 11 mm

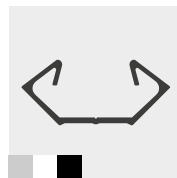

PO23V2 S. 116
max. 11 mm

DP S. 426

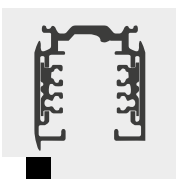

DP10 S. 426

GP S. 420

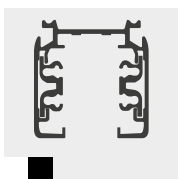

GP20 S. 420

TS S. 430



TS1 S. 434

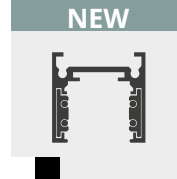

TS2 S. 435

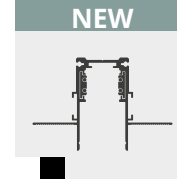

TS3 S. 436

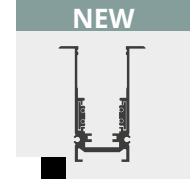

TS4 S. 437

PN S. 120

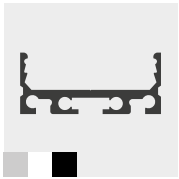

PN4 S. 120
max. 20 mm

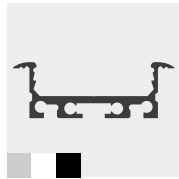

PN5 S. 126
max. 20 mm

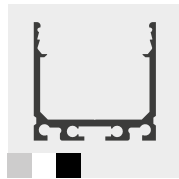

PN6V2 S. 132
max. 20 mm

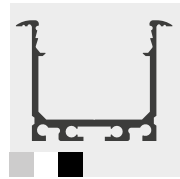

PN7V2 S. 138
max. 20 mm

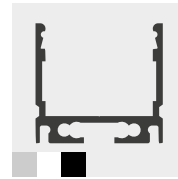

PN8 S. 144
max. 16 mm

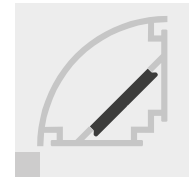

PN10 S. 148
max. 13 mm

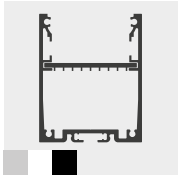

PN17 S. 152
max. 30 mm

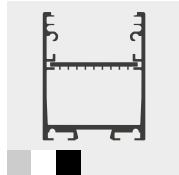

PN17V2 S. 158
max. 30 mm
max. 12 mm

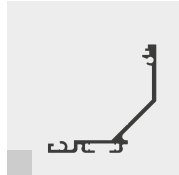

PN19V3 S. 170
max. 20 mm

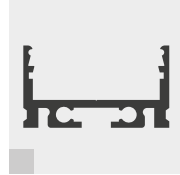

PN20V2 S. 174
max. 20 mm

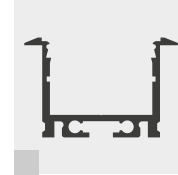

PN21 S. 178
max. 20 mm

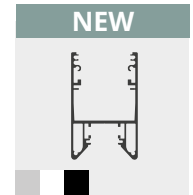

PN27 S. 164
max. 30 mm
max. 12 mm



PN33 S. 182
max. 14 mm

FP S. 186

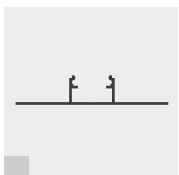

FP1 S. 186
max. 12 mm

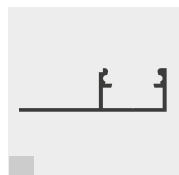

FP2 S. 190
max. 12 mm

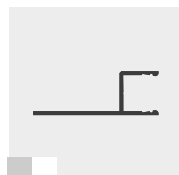

FP3 S. 194
max. 8 mm

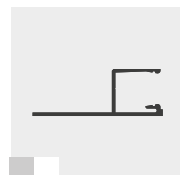

FP4 S. 198
max. 10 mm

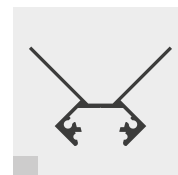

FP5 S. 202
max. 12 mm

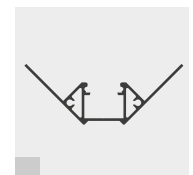

FP8V2 S. 206
max. 12 mm

PI S. 210

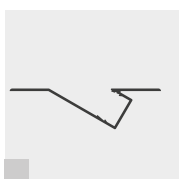

PI3V2 S. 210
max. 13 mm

SV S. 405

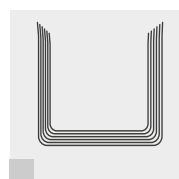

SV1
SV2
SV3
SV4 S. 405
max. 4-16 mm

SR S. 274



SR1 S. 274
max. 10 mm



SR2 S. 274
max. 15 mm

SF S. 292



SF1 S. 292
max. 15 mm

TBP

S. 214

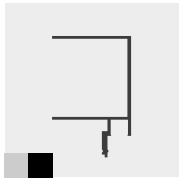

TBP1

S. 214

max. 6 mm

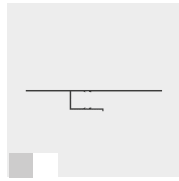

TBP2

S. 218

max. 11 mm

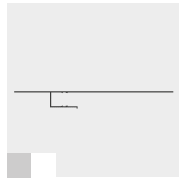

TBP2.1

S. 218

max. 11 mm

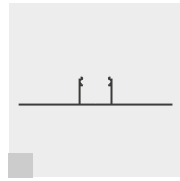

TBP3

S. 224

max. 14 mm

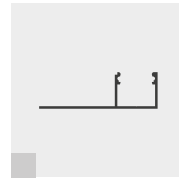

TBP4

S. 228

max. 14 mm

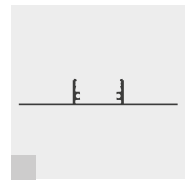

TBP5

S. 232

max. 20 mm

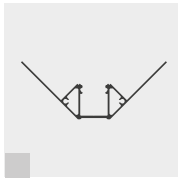

TBP6

S. 238

max. 14 mm

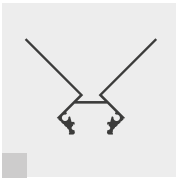

TBP7

S. 242

max. 12 mm

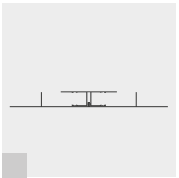

TBP10

S. 246

max. 11 mm

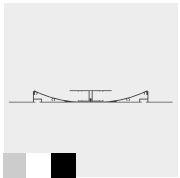

TBP11

S. 250

max. 11 mm



TBP12

S. 254

max. 11 mm

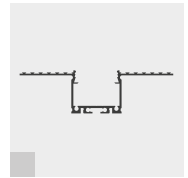

TBP13

S. 258

max. 21 mm

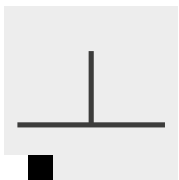

TBP14

S. 262

max. 12 mm

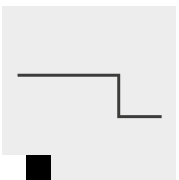

TBP16

S. 266

max. 12 mm

RP

S. 270

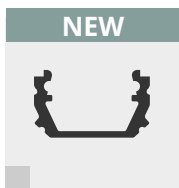

RP

S. 270

max. 10 mm

LL

S. 278

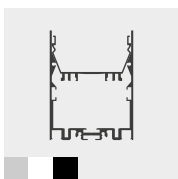

LL2

S. 278

max. 40 mm

max. 5 mm

SP

S. 284

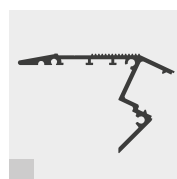

SP1

S. 284

max. 13 mm

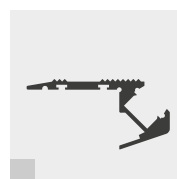

SP2

S. 288

max. 12 mm

WP

S. 366

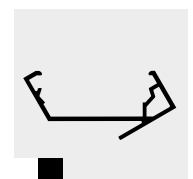

WP1

S. 366

max. 18 mm

VP

S. 386

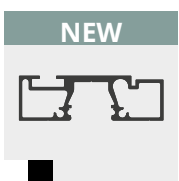

VP1

S. 386

max. 10 mm

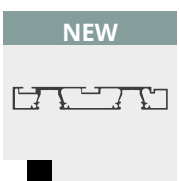

VP2

S. 390

max. 10 mm

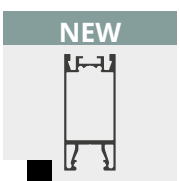

VP3

S. 394

max. 10 mm



VP5

S. 398

max. 10 mm

NL

S. 296

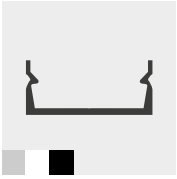

NL8 S. 296

max. 14 mm

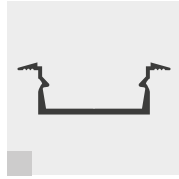

NL8F S. 300

max. 14 mm

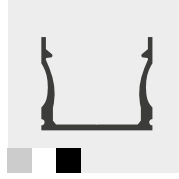

NL15 S. 304

max. 12 mm

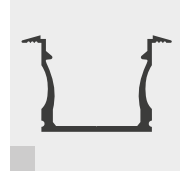

NL15F S. 308

max. 12 mm

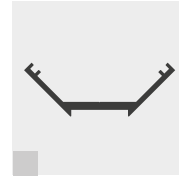

NL10 S. 312

max. 10 mm

VA

S. 316

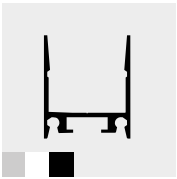

VA1 S. 316

max. 16 mm

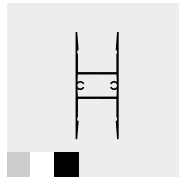

VA2 S. 320

max. 16 mm

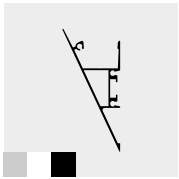

VA3 S. 324

max. 16 mm

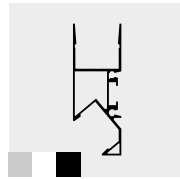

VA4 S. 328

max. 14/16 mm

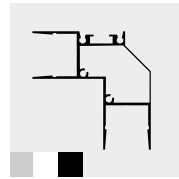

VA5 S. 332

max. 16 mm

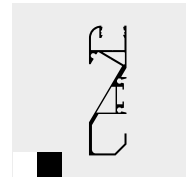

VA6 S. 336

max. 12/14 mm

MP

S. 340

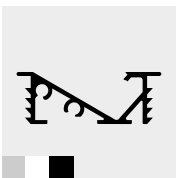

MP1 S. 340

max. 6 mm



MP2 S. 344

max. 6 mm



MP3 S. 348

max. 10 mm

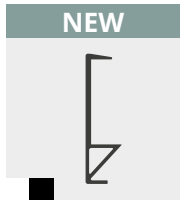

MP4 S. 352

max. 10 mm

PA

S. 414



PA1 S. 414

OEM

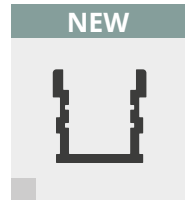

PA3 S. 360

max. 16 mm

PK

S. 370

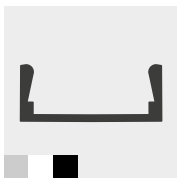

PK1 S. 370

max. 12 mm

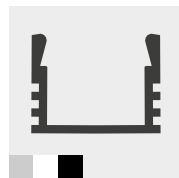

PK2 S. 374

max. 12 mm

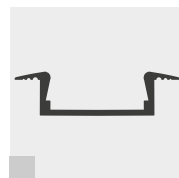

PK8 S. 382

max. 12 mm

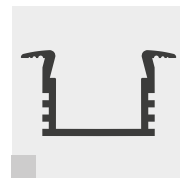

PK3 S. 378

max. 12 mm

BP

S. 356

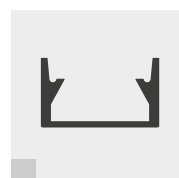

BP2 S. 356

max. 12 mm

Material Material	Resistance towards Beständigkeit gegenüber			
	Indoor area Innenbereich	Outdoor area Außenbereich	Wet/humid environment nass/feuchte Umgebung	UV-resistance UV-Beständigkeit
Steel/sheet steel/spring steel Stahl/Stahlblech/Federstahl	+	0	0	+
Stainless steel Edelstahl	+	+	+	+
Untreated aluminium Aluminium roh	+	+	+	+
Powder-coated aluminium Aluminium pulverbeschichtet	+	+	+	0
Anodized aluminium Aluminium eloxiert	+	+	+	+
Aluminium EN AW-6063-T5 alloy Aluminium EN AW-6063-T5 Legierung	+	+	+	+
PVC PVC	+	+	+	0
Polycarbonate (PC) Polycarbonat (PC)	+	+	+	0
PETG PETG	+	+	0	0
ABS ABS	+	+	+	0
PMMA PMMA	+	+	+	+

+ suitable | geeignet **-** unsuitable | ungeeignet **0** Limited suitability or only suitable with the addition of additives
bedingt geeignet bzw. ausschließlich unter Zusatz von Additiven geeignet



Only suitable for indoor use
Nur für den Innenbereich geeignet



suitable for wet rooms and outdoors
geeignet für Nasszellen und Outdoor

Please note: Information on features serves to better describe our products but should not be considered as corresponding to guaranteed characteristics unless expressly designated as such. / GALAXY reserves the right to introduce changes to favour technical progress or adaptations in compliance with changing standards or regulations. / Photos and drawings in this catalogue are mere design examples and are not binding for delivery design. / GALAXY® profiles GmbH shall assume no responsibility for any unavailability of catalogue products. / GALAXY® profiles GmbH shall assume no responsibility for any direct, indirect, incidental or other damages (including, but not limited to, lost profits, lost revenues, or similar economic loss) arising from the use of information contained in this catalogue. / Violation of intellectual property rights or use of text and layout design (incl. photos) without our permission is prohibited and will be prosecuted.

Bitte beachten Sie: Die Angaben dienen der näheren Artikelbeschreibung, sind jedoch keine zugesicherten Eigenschaften, wenn sie nicht ausdrücklich als solche bezeichnet werden. / Änderungen zu Gunsten des technischen Fortschrittes bzw. Anpassungen an geänderte Normen oder Vorschriften bleiben vorbehalten. / Fotos und Zeichnungen in diesem Katalog sind Ausführungsbeispiele und nicht verbindlich für die Ausführung der Lieferung. / Die Firma GALAXY® profiles GmbH haftet nicht für eine eventuelle Nichtverfügbarkeit der Katalogprodukte. / Die GALAXY® profiles GmbH haftet ebenfalls nicht für jegliche direkte, indirekte, zufällige oder andere Schäden (darunter auch, aber nicht ausschließlich, für entgangene Gewinne, entgangene Erträge oder ähnliche wirtschaftliche Schäden), die durch die Verwendung von Informationen aus diesem Katalog entstehen. / Ein Verstoß gegen Schutzrechte oder eine Verwendung von Text- und Layoutgestaltung (inkl. Fotos) ohne unsere Genehmigung ist nicht gestattet und wird gerichtlich verfolgt.

Join now!

WWW.GALAXY-PROFILES.COM

Unrestricted access to GALAXY® profiles.

- All products
- Detailed specifications
- Applications

Prices and terms!

**FOR WHOLESALERS/RETAILERS,
INDUSTRY AND COMMERCIAL END-USERS.**

Your added value by GALAXY® profiles

- Intelligent product design
- Unique product compatibility
- Guaranteed product quality
- Best price-performance ratio
- Sustainable product availability and spare parts supply
- High product availability ex stock
- Many years of experience and know-how
- Competent specialist advice
- First-class comprehensive and personal service
- Customized assembling
- OEM production – standard profiles with 5,5 m length/
standard covers with 6 m length
- Customized packaging/labeling on demand
- Sales support
 - Marketing materials
 - Sample boxes
 - Professional product catalogues in any language

PERSONAL ADVICE ON THE SITE

Jetzt registrieren!

WWW.GALAXY-PROFILES.COM

Uneingeschränkter Zugriff auf GALAXY® profiles.

- Alle Produkte
- Detaillierte Spezifikationen
- Anwendungen

Mit Preisen und Konditionen!

**FÜR GROSS-/FACHHANDEL, INDUSTRIE
UND GEWERBLICHE ENDABNEHMER.**

Ihr Mehrwert mit GALAXY® profiles!

- Intelligentes Produktdesign
- Einzigartige Produktkompatibilität
- Garantierte Produktqualität
- Ausgezeichnetes Preis-/Leistungsverhältnis
- Nachhaltige Produkt- und Ersatzteilverfügbarkeit
- Hohe Produktverfügbarkeit ab Lager
- Langjährige Erfahrung und Know-how
- Kompetente/Zuverlässige Fachberatung
- Wirtschaftliche Stabilität des Unternehmens
- Full-Service und persönlicher Support
- Kundenspezifische Konfektionierung nach Maß
- OEM Fertigung bei Standard-Alu-Profilen bis 5,5 m/bei
Abdeckungen bis 6 m – ohne Gärungsschnitt!
- Kundenspezifische Verpackung/Etikettierung etc.
- Vertriebsunterstützung mit
 - Marketingmaterial,
 - Musterboxen und
 - professionellen Produktkatalogen (auch als
hochwertige Printversion) – in jeder Sprache!

PERSÖNLICHE BERATUNG VOR ORT!



**Discover the
GALAXY® infrared
catalogue!**

**Entdecken Sie
den GALAXY®
Infrarot Katalog!**

GALAXY® profiles GmbH
Zeller Berg 2c | 6060 Kufstein
Austria | Europe

T +43 5372 22260
M info@galaxy-profiles.com
W www.galaxy-profiles.com



Homogeneous lighting with perfect light lines from GALAXY® profiles

- Guaranteed product quality at the best price-performance ratio
- Intelligent product design with unique product compatibility
- An unlimited variety of designs and high product availability
- Many years of experience and know-how
- Competent specialist advice and a first-class comprehensive service

BECOME OUR DISTRIBUTOR FOR GALAXY® PROFILES.

www.galaxy-profiles.com

- Garantierte Produktqualität zum besten Preis-/Leistungsverhältnis
- Intelligentes Produktdesign mit einzigartiger Produktkompatibilität
- Grenzenlose Designvielfalt und hohe Produktverfügbarkeit
- Langjährige Erfahrung und Know-how
- Kompetente Fachberatung und erstklassiger Full-Service

WERDEN SIE UNSER VERTRIEBSPARTNER FÜR GALAXY® PROFILES.

www.galaxy-profiles.com

GALAXY® profiles GmbH

Zeller Berg 2c | 6330 Kufstein |
Austria | Europe

T +43 5372 22260

M info@galaxy-profiles.com

W www.galaxy-profiles.com

GALAXY® profiles

Perfect Light Lines



**Discover the
GALAXY® infrared
catalogue!**

**Entdecken Sie den
GALAXY® Infrarot
Katalog!**