

NEW
edition

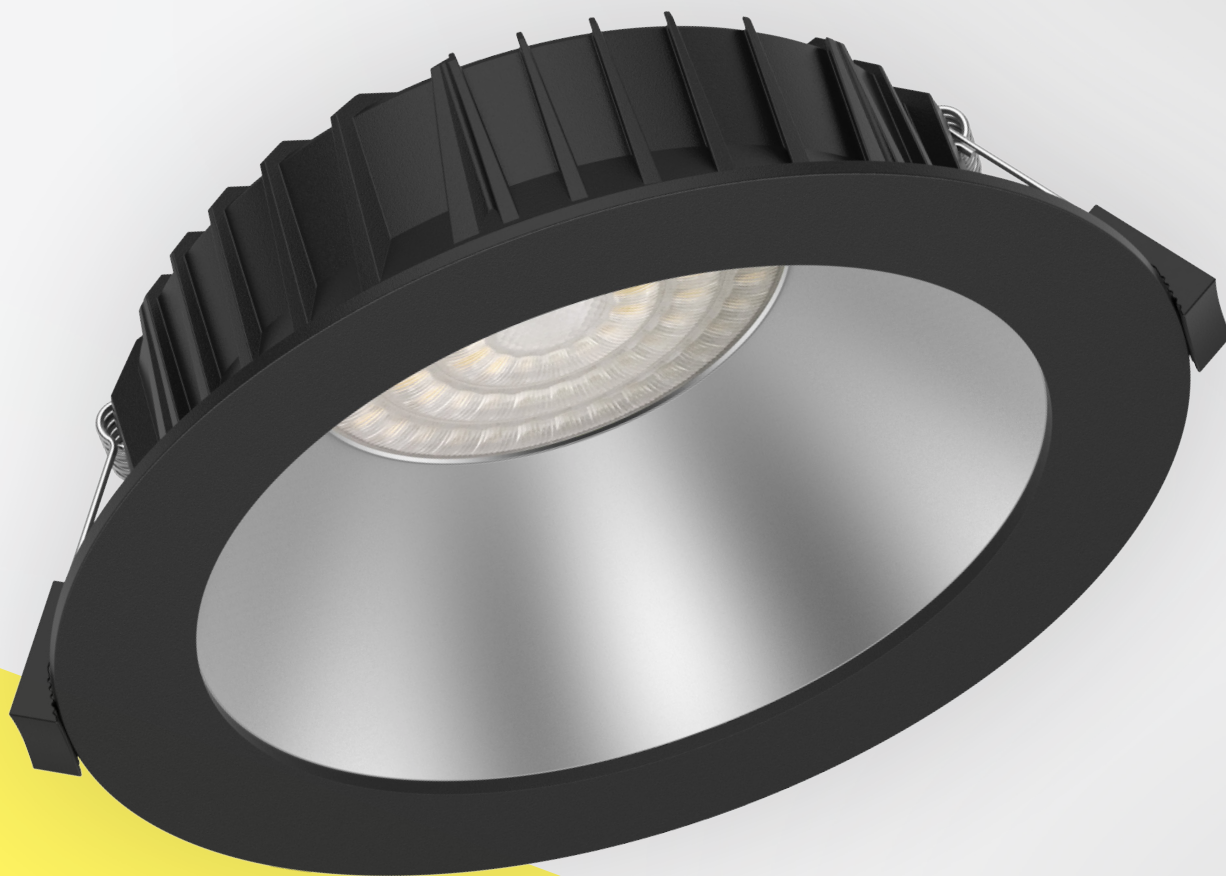

lighting guide

TRONIX guided by light







We care for our clients. We help them do what they do best. We strive to build a long-term relationship, so that we can rely on one another unconditionally.

We zorgen voor onze klanten. We helpen ze te doen waar ze goed in zijn. We streven naar een duurzame relatie, zodat we onvoorwaardelijk op elkaar kunnen bouwen.

Light connects. It creates atmosphere, experiences and emotion. As a comprehensive LED supplier, we have the perfect answer for any light-related question. For you, for ourselves, and out of respect for the beauty around us. We're guided by light.

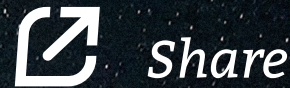

Knowledge is power, but sharing is even more powerful. Because sharing means: growing together. We as a supplier, and our client as an authority/specialist for their own clients.

Kennis is kracht, kennis delen is nog veel krachtiger. Want delen betekent: samen groeien. Wij als leverancier, en onze klant als autoriteit/specialist voor zijn eindklant.



We connect people and partners. Together, we can make one plus one equal three. We see the market as a dynamic playing field, where together we can make 'beautiful' even more beautiful!

We verbinden mensen en partijen. Samen maken we van één plus één drie. We zien de markt als een dynamisch speelveld, waarin we samen 'mooi' nog mooier maken.



TRONIX guided by light

Lighting guide 2024

🇬🇧 Our stock-holding product selection is bigger than big: We can provide anything you need, so you don't have to shop around. With our LED solutions for every light application, your project is in good hands with our light experts. We bring lighting solutions that excel in function and wow factor.

Whether we do it from scratch or via reverse engineering, we always develop products using the best components, technical specifications and contemporary designs. Quality and satisfied customers are our first priorities. As light pioneers, we have a partner network that reaches around the globe, giving us a leading position with first-class light. You do business with us, we'll do business with the rest of the world. And going that extra mile for you is just in our DNA.

🇳🇱 Ons aanbod is groter dan groot en uit voorraad leverbaar. Bij ons vind je wat je zoekt, gewoon op één adres. Met led-oplossingen voor elke lichttoepassing is je project hier in goede handen. Wij gaan voor lichtoplossingen die uitblinken in functie én wow-factor.

Van 'scratch' of vanuit een bestaand ontwerp (reverse engineering) ontwikkelen we producten met de beste componenten, technische specificaties en eigentijdse designs. Kwaliteit en tevreden klanten staan bij ons op nummer één. Als lichtpioniers hebben we een wereldwijd partner netwerk voor een koppositie met eersteklas licht. Jij doet zaken met ons, wij met de rest van de wereld. En die extra stap zetten we graag voor je, dat zit gewoon in ons DNA.





Office and showroom in Uden - The Netherlands



Looking for our latest product releases? We keep continued focus on new product development and further extension of our range. Visit our website for a most actual overview.

Op zoek naar onze allernieuwste producten? We werken voortdurend aan nieuwe productontwikkeling en een verdere uitbreiding van ons assortiment. Bezoek onze website voor het meest actuele overzicht!



Order online? Ask for your personal login account at sales@tronixlighting.com



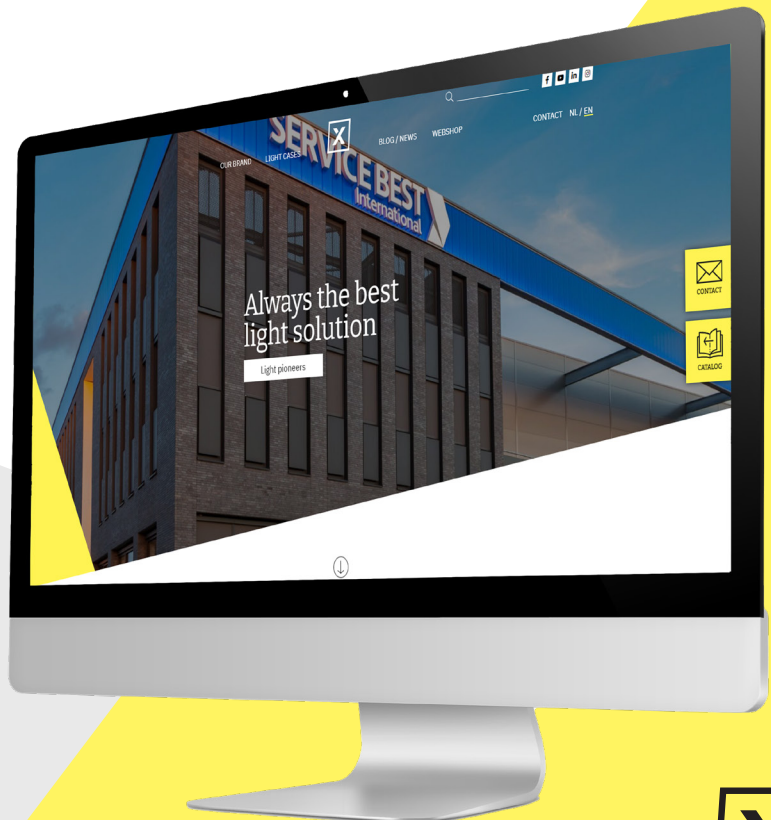





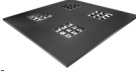

Orders placed before 12.00h (GMT +1) will be shipped the same day



Check our complete
catalog range online
Bekijk alle Tronix product
catalogi online



Content

1. Downlights & Spots		10
2. LED Panels		24
3. Ceiling & Wall Lights		36
4. Track Light		50
5. Recessed Fixtures		58
6. LED Light Sources		66
7. Emergency Light		76
8. High Bays		88
9. Industrial Fixtures & Line Lighting		94
10. Flood Light		100
11. Area Lighting		104
12. Garden Lights & Ground Spots		110

Photography / Fotografie:

 Marique fotografie /  Hans Koster /  Ronald Strijbosch /  Margot van den Nieuwenhuizen

The images and information provided in this catalogue are composed with great care, but may be always subject to alterations. Tronix Lighting accepts no liability for misprints, errors or unforeseen changes.

De beelden en informatie zoals deze zijn weergegeven in deze catalogus zijn met zorg samengesteld maar blijven altijd onder voorbehoud. Tronix Lighting accepteert geen aansprakelijkheid voor drukfouten en onvoorziene wijzigingen.

Technical indications

There is a lot to know about light and we think it is important to share this knowledge with you. Why? Because we place high demands on the quality of our lighting products, and this information will help you to qualify and compare products better. Below overview of important technical specifications and measurement factors can be of help.

CRI value

The Color Rendering or Color Rendering Index (CRI value) tells you on a scale of 0-100% how 'true' a light source represents the colors compared to real daylight. The higher the CRI value of a light source, the more real the colors. A CRI value value of 80 means a quite high color rendering; CRI value values of 90 or more have an excellent color rendering.

Dimming

LED can be dimmed in many ways. A primary condition is that the LED lamp itself is suitable for dimming, and also the dimmer must be fit for controlling the LED. On top of that, the driver needs to be suitable for the combination of dimmer and LED lamp. And there is a difference of control between LED dimmers: it can be analogue (0-10 V, 1-10V, trailing edge dimming) or digital (DALI, Casambi dimming).

Human Centric Lighting

Human Centric Lighting has an undeniable impact on our daily rhythm and well-being. The slow change from light to dark not only controls our biological clock, but also affects our health, mood and productivity. This is where artificial light can help by gradually changing from cold to warm white throughout the day. Just like real daylight. You can recognise products that can meet this requirement by the 'HCL' logo.

Flicker-free

The flickering of a light source is expressed in a Flicker percentage, and caused by the quality of the used LED driver. The lower the percentage, the better. A Flicker value > 35% is experienced as very annoying; values up to 15% can cause fatigue or headaches. All Tronix lighting and LED drivers have a flicker percentage below <1% and therefore meet all current EPREL requirements.

IP rate

Ingress Protection (International Protection Rating) of a product, normalized to the IEC60529 standard. The IP value is expressed in 2 digits; the first number indicates the protection value against dust/touch, the second number the protection value against moisture. In case of LED lighting, IP ratings vary from IP20, non- or poorly resistant to dust and moisture, up to IP68 - water resistant and 100% dust resistant.

IK rate

The Impact Protection Rating says something about the impact resistance of a luminaire, so to what extent it is resistant to mechanical shocks. In practice, this value varies from IK02 to IK10. The higher the IK value, the higher the impact resistance. Tronix wall/ceiling luminaires vary in value from IK08 (resistant to 5 Joule shocks) to IK10 (vandal-proof with a 20 Joule shock resistance).

Kelvin

The Kelvin (K) value indicates the color temperature. The lower the Kelvin value, the warmer the light looks. The higher the number of Kelvin, the 'colder' the light. The standard Kelvin values for Led lighting start at 2300K (warm white) to 7000K (cold white).

Lifespan

The lifespan of LED is many times longer than that of conventional lighting, such as incandescent lamps. A good LED easily achieves a lifespan of 50,000 hours, however the actual lifetime of the LED strongly depends on the ambient temperature (in connection with cooling), and the electronics used. The more stable the strength of current, the longer the lifespan. The humidity level of the Led environment is also an influential factor. In the course of time, it is however inevitable that the Luminous flux will eventually decrease to a maximum of 70%.

Luminous flux

The amount of light(current) that a light source produces, in other words the sum of all emitted light, regardless of the direction in which the light shines. The Luminous flux value is often expressed as Luminous flux per Watt, which expresses the efficiency of the LED. With a Luminous flux of >130 Lm / Watt, Tronix high efficiency panels score very high on an operating efficiency level.

LUX

The amount of lux is the most reliable measurement value for lighting and says something about the amount of light (Luminous flux) that ends up on a certain surface. 1 lux = 1 Lm / m². For example: a light source of 1000 Lm spread over 1 m² illuminates that square meter with 1000 Lux. Spread that same 1000 Lm over 10m², and it will then only illuminate 100 Lux. European standards for lux values in various interior lighting environments are captured in NEN 1246-1 regulations.

Power factor

The power factor represents the relationship between the actual power (P) and the apparent power (Ps). The lower the power factor, the higher the unwanted power consumption. High quality Led lighting has a power factor of at least 0.90 and is now running up to 0.95 (max. 5% undesired power consumption). Inferior LED products have a considerably lower power factor; In addition to higher electricity costs, this also results in dangerous situations due to the large amount of reactive current.

UGR

The Unified Glare Rating indicates the degree of light nuisance or glare. The average value is between 15 and 30. Below 10 there is no glare.

Communication protocol

With a large variation in control and dimming techniques, the possibilities with the current Tronix range are endless. For example; we have DALI, Casambi, Zigbee, DMX, triac and 1-10V. Can't find the right protocol? Each fixture can be supplied with integrated control in any desired protocol, simply ask us about the options and possibilities.

Technische aanduidingen

Er is veel te weten over licht en wij vinden het belangrijk om deze kennis met u te delen. Waarom? Omdat we hoge eisen stellen aan de kwaliteit van onze verlichting, en deze informatie u zal helpen om producten beter te beoordelen en met elkaar te vergelijken. Onderstaand overzicht van belangrijke technische specificaties en meefactoren zijn hierbij een helpende hand.



CRI value

De kleurweergave of Color Rendering Index (CRI value) geeft op een schaal van 0-100% aan hoe 'kleurecht' een lichtbron de kleuren weergeeft in vergelijking tot daglicht. Hoe hoger de CRI value van een lichtbron, hoe echter de kleuren. Een CRI value waarde van 80 betekent een hoge kleurweergave; CRI value waarden van 90 of meer hebben een uitstekende kleurweergave.



Dimming

Led is op vele manieren te dimmen. Voorwaarde is wel dat de ledlamp zelf geschikt is om te dimmen en de dimmer moet ook geschikt zijn voor het aansturen van de led. Bij aanwezigheid van een driver moet deze daarnaast ook geschikt zijn voor de combinatie dimmer en ledlamp. Tussen led-dimmers zit ook nog een verschil van aansturing, deze kan analoog (0-10 V, 1-10V, fase aan-/afsnijding dimming) of digitaal zijn (DALI, Casambi).



Human Centric Lighting

Human Centric Lighting heeft een onmiskenbare invloed op ons dagritme én ons welbevinden. De geleidelijke wisseling van licht naar donker stuurt niet alleen onze biologische klok aan, maar heeft ook invloed op onze gezondheid, ons humeur en onze productiviteit. Kunstlicht kan hier in ondersteunen door gedurende de dag en heel geleidelijk over te schakelen van koud naar warm wit. Net als echt daglicht. Producten die hieraan kunnen voldoen herken je door het 'HCL' logo.



Flikkervrij

Het knipperen van een lichtbron wordt uitgedrukt in een flikkerpercentage, en veroorzaakt door de kwaliteit van de gebruikte led-driver. Hoe lager het percentage, hoe beter. Een flikkerwaarde >35% wordt als zeer hinderlijk ervaren; waarden tot 15% kunnen vermoeidheids- of hoofdpijnklachten veroorzaken. Alle Tronix verlichting en led-drivers hebben een flikkerpercentage onder de <1% en voldoen daarmee aan alle huidige EPREL eisen.



IP rate

Ingress Protection (International Protection Rating) van een product, genormaliseerd volgens de IEC60529 norm. De IP waarde wordt in 2 cijfers uitgedrukt; het eerste getal geeft de beschermwaarde aan tegen stof/aanraken, het tweede getal de beschermwaarde tegen vocht. In de ledverlichting variëren de IP ratings van IP20 – niet (goed)bestendig tegen stof en vocht – tot aan IP68 – waterbestendig en 100% stofbestendig.



IK rate

De Impact Protection Rating zegt iets over de slagvastheid van een armatuur, dus in hoeverre deze bestand is tegen mechanische schokken. In de praktijk varieert deze waarde van IK02 tot IK10. Hoe hoger de IK waarde, hoe hoger de slagvastheid. De wand-/plafondarmaturen van Tronix variëren in waarde van IK08 (weerstand tegen schokken van 5 Joule) tot IK10 (vandalismebestendig met een weerstand tegen schokken van 20 Joule).



Kelvin

De Kelvin (K) waarde duidt op de kleurtemperatuur. Hoe lager de K waarde, hoe warmer het licht oogt. Hoe hoger het aantal Kelvin, hoe 'koudere' het licht. De standaard Kelvin-waarden beginnen bij 2300K (warm wit) tot 7000K (koud wit).



Levensduur

De levensduur van ledverlichting is vele malen langer dan dat van conventionele verlichting zoals gloei- en halogeenlampen. Een goede led haalt makkelijk een levensduur van 50.000 uur, echter de uiteindelijke levensduur van de led is sterk afhankelijk van de omgevingstemperatuur (i.v.m. koeling), en de gebruikte elektronica. Hoe stabielere de stroomsterkte hoe langer de levensduur. Ook de vochtigheidsgraad van de led omgeving is nog van invloed. Overigens loopt de lichtopbrengst na verloop van tijd wel enigszins terug tot maximaal 70%.



Luminous flux

De hoeveelheid licht(stroom) die een lichtbron oplevert, oftewel de som van al het uitgestraalde licht ongeacht de richting waarin het licht straalt. De Luminous flux waarde wordt vaak uitgedrukt per stroomeenheid (Lm/W) om de efficiëntie van de led uit te drukken. Tronix high efficiency panelen scoren met een lichtopbrengst van >130 Lm/Watt hoog in gebruiksefficiëntie.



LUX

De hoeveelheid lux is de meest betrouwbare meetwaarde voor verlichting en zegt iets over de hoeveelheid licht (Luminous flux) die er op een bepaald oppervlak terecht komt. 1 lux = 1 Lm/m². Vb: een lichtbron van 1000 Lm, verspreid over 1 m², verlicht die vierkante meter met 1000 Lux. Verspreid over 10m² verlicht die zelfde 1000 Lm slechts 100 Lux. De gestelde Europese normen voor luxwaarden in diverse binnenverlichtingsomgevingen zijn vastgelegd in NEN 1246-1.



Power factor

De power factor geeft de relatie weer tussen het werkelijke vermogen (P) en het schijnbare vermogen (Ps). Hoe lager de power factor, hoe hoger het ongewenste stroomverbruik. Hoge kwaliteit ledverlichting heeft een powerfactor van minimaal 0,90 en loopt inmiddels tegen de 0,95 (max. 5% ongewenst stroomverbruik). Inferieure led-producten hebben een aanzienlijk lagere power factor; behalve hogere stroomkosten levert dit ook gevaarlijke situaties op door de grote hoeveelheid blindstroom.



UGR

De Unified Glare Rating geeft aan in hoeverre er sprake is van lichthinder of verblinding. De gemiddelde waarde ligt tussen de 15 en de 30. Beneden de 10 is er geen sprake van verblinding.



Communicatieprotocol

Met een grote variatie in aansturing en dimtechnieken zijn de mogelijkheden met het huidige Tronix verlichtingsassortiment eindeloos. Zo beschikken we over DALI, Casambi, Zigbee, DMX, triac en 1-10V. Toch niet het juiste protocol beschikbaar? Elk armatuur is te leveren met geïntegreerde aansturing in elk gewenst protocol. Vraag ons naar de opties en mogelijkheden.

1

Downlights

The right solution for a wide
variety of applications





Downlights & Spots | Reflector

LED REFLECTOR DOWNLIGHT MATT | 3-CCT | BLACK

With CCT switch for pre-settable color temperature 3000K - 4000K - 5700K and pre-settable powerswitch on the external driver (five power settings).



- Input voltage:** 220-240V
- Power:** 6~10/6~15/13~25 Watt
- Driver:** External driver (non-dimmable) included
- Dimmable:** Optional
- UGR:** <19
- Beam angle:** 90°
- IP rate:** IP54 (when mounted)
- Mounting:** Recessed
- Cable length:** 200 cm
- Connection type:** Europlug
- Housing frame:** PC/aluminium (black coated)



ART. NR.	MAX. POWER	MAX. LUMINOUS FLUX	LIGHT COLOR	DIAMETER	HEIGHT	MOUNTING HOLE
136-135	10 Watt	1342 Lm	3-CCT	Ø 145 mm	55 mm	Ø 118 mm
136-136	15 Watt	1837 Lm	3-CCT	Ø 170 mm	58 mm	Ø 138 mm
136-137	15 Watt	1942 Lm	3-CCT	Ø 190 mm	61 mm	Ø 158 mm
136-138	25 Watt	3265 Lm	3-CCT	Ø 228 mm	61 mm	Ø 199 mm

*See website for detailed power- and luminous specs

DIMMABLE DRIVERS

POWER	TRIAC	1-10V	DALI	RF	ZIGBEE	CASAMBI
10 Watt	215-205	215-601	215-272	214-184	214-260	215-295
15 Watt	215-380	215-601	215-267	214-184	214-261	215-295
25 Watt	215-206	215-601	215-605	214-184	214-261	215-296

Reflector | Downlights & Spots

LED REFLECTOR DOWNLIGHT MATT | 3-CCT | WHITE



With CCT switch for pre-settable color temperature 3000K - 4000K - 5700K and pre-settable powerswitch on the external driver (five power settings).



- Input voltage:** 220-240V
- Power:** 6~10/6~15/13~25 Watt
- Driver:** External driver (non-dimmable) included
- Dimmable:** Optional
- UGR:** <19
- Beam angle:** 90°
- IP rate:** IP54 (when mounted)
- Mounting:** Recessed
- Cable length:** 200 cm
- Connection type:** Europlug
- Housing frame:** PC/aluminium (white coated)



ART. NR.	MAX. POWER	MAX. LUMINOUS FLUX	LIGHT COLOR	DIAMETER	HEIGHT	MOUNTING HOLE
136-131	10 Watt	1362 Lm	3-CCT	Ø 145 mm	55 mm	Ø 118 mm
136-132	15 Watt	1854 Lm	3-CCT	Ø 170 mm	58 mm	Ø 138 mm
136-133	15 Watt	1952 Lm	3-CCT	Ø 190 mm	61 mm	Ø 158 mm
136-134	25 Watt	3287 Lm	3-CCT	Ø 228 mm	61 mm	Ø 199 mm

*See page 12 for dimmable drivers

ACCESSORIES

ART. NR.	ACCESSORIES
136-154	Surface mounting kit for 136-131
136-155	Surface mounting kit for 136-133
136-156	Surface mounting kit for 136-134
136-157	Surface mounting kit for 136-135
136-158	Surface mounting kit for 136-137
136-159	Surface mounting kit for 136-138

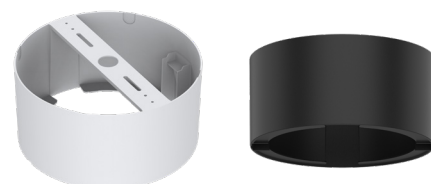

Downlights & Spots | Reflector

LED REFLECTOR DOWNLIGHT | 3-CCT | BLACK

With CCT switch for pre-settable color temperature 3000K - 4000K - 5700K and pre-settable powerswitch on the external driver (five power settings).



- Input voltage:** 230V
- Power:** 5~8/6~15/13~25/18~30 Watt
- Driver:** External driver (Non-dimmable) included
- Dimmable:** Optional
- UGR:** <19
- Beam angle:** 60°
- IP rate:** IP54 (when mounted)
- Mounting:** Recessed
- Cable length:** 120 cm
- Connection type:** Europlug
- Housing frame:** PC/aluminium (black coated)



ART. NR.	MAX. POWER	MAX. LUMINOUS FLUX	LIGHT COLOR	DIAMETER	HEIGHT	MOUNTING HOLE
136-450	8 Watt	550 Lm	3-CCT	Ø 95 mm	55 mm	Ø 82-88 mm
136-451	10 Watt	680 Lm	3-CCT	Ø 108 mm	55 mm	Ø 90-95 mm
136-452	15 Watt	1410 Lm	3-CCT	Ø 145 mm	77 mm	Ø 125-135 mm
136-453	15 Watt	1640 Lm	3-CCT	Ø 172 mm	90 mm	Ø 150-165 mm
136-454	25 Watt	2700 Lm	3-CCT	Ø 172 mm	90 mm	Ø 150-165 mm
136-455	15 Watt	1720 Lm	3-CCT	Ø 228 mm	107 mm	Ø 200-210 mm
136-456	30 Watt	3300 Lm	3-CCT	Ø 228 mm	107 mm	Ø 200-210 mm
136-457	15 Watt	1750 Lm	3-CCT	Ø 280 mm	123 mm	Ø 230-260 mm
136-458	30 Watt	3400 Lm	3-CCT	Ø 280 mm	123 mm	Ø 230-260 mm

*See website for detailed power- and luminous specs

DIMMABLE DRIVERS

POWER	TRIAC	1-10V	DALI	RF	ZIGBEE	CASAMBI
8 Watt	215-205	215-601	215-272	-	214-260	215-295
10 Watt	215-205	215-601	215-272	214-184	214-260	215-295
15 Watt	215-380	215-601	215-267	214-184	214-261	215-295
25 Watt	215-206	215-602	215-605	214-184	214-261	215-296
30 Watt	215-282	215-602	215-605	214-184	-	215-296



Reflector | Downlights & Spots

LED REFLECTOR DOWNLIGHT | 3-CCT | WHITE

With CCT switch for pre-settable color temperature 3000K - 4000K - 5700K and pre-settable powerswitch on the external driver (five power settings).



- Input voltage:** 230V
- Power:** 5~8/6~15/13~25/18~30 Watt
- Driver:** External driver (non-dimmable) included
- Dimmable:** Optional
- UGR:** <19
- Beam angle:** 60°
- IP rate:** IP54 (when mounted)
- Mounting:** Recessed
- Cable length:** 120 cm
- Connection type:** Europlug
- Housing frame:** PC/aluminium (white coated)



ART. NR.	MAX. POWER	AMX. LUMINOUS FLUX	LIGHT COLOR	DIAMETER	HEIGHT	MOUNTING HOLE
136-440	8 Watt	550 Lm	3-CCT	Ø 95 mm	55 mm	Ø 82-88 mm
136-441	10 Watt	680 Lm	3-CCT	Ø 108 mm	55 mm	Ø 90-95 mm
136-442	15 Watt	1410 Lm	3-CCT	Ø 145 mm	77 mm	Ø 125-135 mm
136-443	15 Watt	1640 Lm	3-CCT	Ø 172 mm	90 mm	Ø 150-165 mm
136-444	25 Watt	2700 Lm	3-CCT	Ø 172 mm	90 mm	Ø 150-165 mm
136-445	15 Watt	1720 Lm	3-CCT	Ø 228 mm	107 mm	Ø 200-210 mm
136-446	30 Watt	3300 Lm	3-CCT	Ø 228 mm	107 mm	Ø 200-210 mm
136-447	15 Watt	1750 Lm	3-CCT	Ø 280 mm	123 mm	Ø 230-260 mm
136-448	30 Watt	3400 Lm	3-CCT	Ø 280 mm	123 mm	Ø 230-260 mm

*See page 14 for dimmable drivers

Downlights & Spots | Reflector

LED REFLECTOR DOWNLIGHT COB | BLACK

Pre-settable powerswitch on the external driver (five power settings).



- Input voltage:** 220-240V
- Power:** 6~15/13~25 Watt
- Driver:** External driver (Non-dimmable) included
- Dimmable:** Optional
- UGR:** <19
- Beam angle:** 60°
- IP rate:** IP54 (when mounted)
- Mounting:** Recessed
- Cable length:** 120 cm
- Connection type:** Europlug
- Housing frame:** Glass/aluminium (black coated)



Universal plug, Art. nr. 595-033

ART. NR.	MAX. POWER	MAX. LUMINOUS FLUX	LIGHT COLOR	COLOR TEMP.	DIAMETER	HEIGHT	MOUNTING HOLE
136-360	15 Watt	1590 Lm	3000K	☉ Warm white	Ø 190 mm	75 mm	Ø 160 mm
136-361	15 Watt	1680 Lm	4000K	○ Natural white	Ø 190 mm	75 mm	Ø 160 mm
136-362	25 Watt	3100 Lm	3000K	☉ Warm white	Ø 190 mm	75 mm	Ø 160 mm
136-363	25 Watt	3450 Lm	4000K	○ Natural white	Ø 190 mm	75 mm	Ø 160 mm

*See website for detailed power- and luminous specs

DIMMABLE DRIVERS

POWER	TRIAC	1-10V	DALI	RF	ZIGBEE	CASAMBI
15 Watt	215-380	215-601	215-267	214-184	214-261	215-295
25 Watt	215-206	215-602	215-605	214-184	214-261	215-296
30 Watt	215-282	215-602	215-605	214-184	-	215-296



Reflector | Downlights & Spots

LED REFLECTOR DOWNLIGHT COB | WHITE

Pre-settable powerswitch on external driver (five power settings).



- Input voltage:** 220-240V
- Power:** 6~15/13~25/18~30 Watt
- Driver:** External driver (non-dimmable) included
- Dimmable:** Optional
- UGR:** <19
- Beam angle:** 60°
- IP rate:** IP54 (when mounted)
- Mounting:** Recessed
- Cable length:** 120 cm
- Connection type:** Europlug
- Housing frame:** Glass/aluminium (white coated)

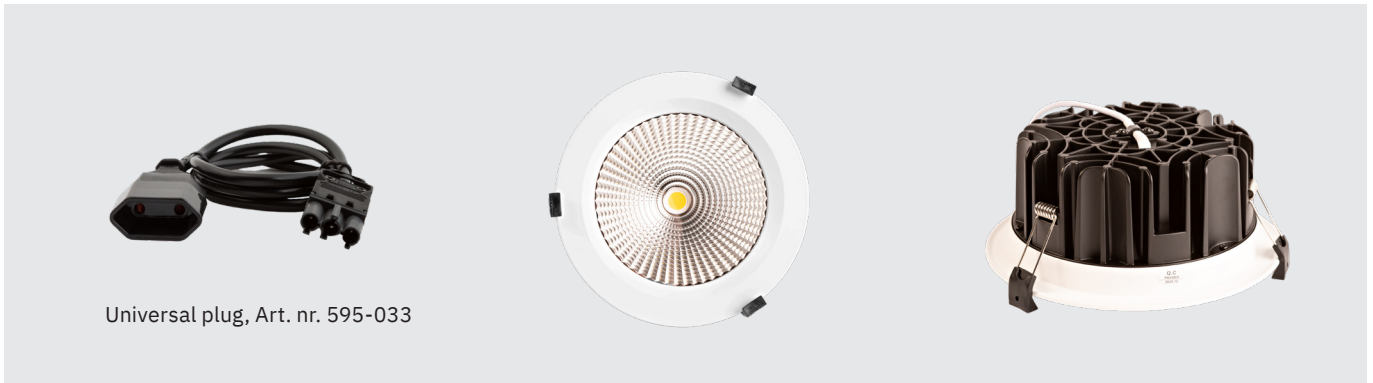

Universal plug, Art. nr. 595-033

ART. NR.	MAX. POWER	MAX. LUMINOUS FLUX	LIGHT COLOR	COLOR TEMP.	DIAMETER	HEIGHT	MOUNTING HOLE
136-350	15 Watt	1590 Lm	3000K	☉ Warm white	Ø 190 mm	75 mm	Ø 160 mm
136-352	15 Watt	1680 Lm	4000K	○ Natural white	Ø 190 mm	75 mm	Ø 160 mm
136-354	15 Watt	1590 Lm	3000K	☉ Warm white	Ø 225 mm	87 mm	Ø 200 mm
136-356	15 Watt	1680 Lm	4000K	○ natural white	Ø 225 mm	87 mm	Ø 200 mm
136-351	25 Watt	2600 Lm	3000K	☉ Warm white	Ø 190 mm	75 mm	Ø 160 mm
136-353	25 Watt	2800 Lm	4000K	○ Natural white	Ø 190 mm	75 mm	Ø 160 mm
136-355	30 Watt	3100 Lm	3000K	☉ Warm white	Ø 225 mm	87 mm	Ø 200 mm
136-357	30 Watt	3450 Lm	4000K	○ Natural white	Ø 225 mm	87 mm	Ø 200 mm

*See page 16 for dimmable drivers

Downlights & Spots | Reflector

REFLECTOR DOWNLIGHT ECO | 3-CCT | BLACK

With CCT switch for pre-settable color temperature 3000K - 4000K - 6000K and pre-settable powerswitch on the external driver (two power settings).



- Input voltage:** 220-240V
- Power:** 7~10/10~14/14~20/20~28 Watt
- Driver:** External driver (non-dimmable) included
- Dimmable:** Optional
- UGR:** <19
- Beam angle:** 50°
- IP rate:** IP44 (when mounted)
- Mounting:** Recessed
- Cable length:** 120 cm
- Connection type:** Europlug
- Housing frame:** PC/aluminium (black coated)



ART. NR.	MAX. POWER	MAX. LUMINOUS FLUX	LIGHT COLOR	DIAMETER	HEIGHT	MOUNTING HOLE
136-195	10 Watt	1010 Lm	3-CCT	Ø 113 mm	65,5 mm	Ø 90 mm
136-196	14 Watt	1393 Lm	3-CCT	Ø 145 mm	81,8 mm	Ø 120 mm
136-197	20 Watt	2052 Lm	3-CCT	Ø 174 mm	90 mm	Ø 145 mm
136-198	28 Watt	3024 Lm	3-CCT	Ø 232 mm	118 mm	Ø 195 mm

*See website for detailed power- and luminous specs

DIMMABLE DRIVERS

POWER	TRIAC	1-10V	DALI	RF	ZIGBEE	CASAMBI
10 Watt	215-380	215-601	215-272	214-184	214-260	215-295
14 Watt	215-280	215-601	215-267	214-184	214-261	215-295
20 Watt	215-281	215-601	215-267	214-184	214-261	215-295
28 Watt	215-282	215-602	215-605	214-184	-	215-296

Reflector | Downlights & Spots

REFLECTOR DOWNLIGHT ECO | 3-CCT | WHITE

With CCT switch for pre-settable color temperature 3000K - 4000K - 6000K and pre-settable powerswitch on the external driver (two power settings).



- Input voltage:** 220-240V
- Power:** 7~10/10~14/14~20/20~28 Watt
- Driver:** External driver (non-dimmable) included
- Dimmable:** Optional
- UGR:** <19
- Beam angle:** 50°
- IP rate:** IP44 (when mounted)
- Mounting:** Recessed
- Cable length:** 120 cm
- Connection type:** Europlug
- Housing frame:** PC/aluminium (white coated)



ART. NR.	MAX. POWER	MAX. LUMINOUS FLUX	LIGHT COLOR	DIAMETER	HEIGHT	MOUNTING HOLE
136-112	10W	1010 Lm	3-CCT	Ø 113 mm	65,5 mm	Ø 90 mm
136-115	14W	1393 Lm	3-CCT	Ø 145 mm	81,8 mm	Ø 120 mm
136-118	20W	2052 Lm	3-CCT	Ø 174 mm	90 mm	Ø 145 mm
136-121	28W	3024 Lm	3-CCT	Ø 232 mm	118 mm	Ø 195 mm

*See page 18 for dimmable drivers



Toilet area with black reflector spot 3000K Art.nr 136-103, van Tienen Zeeland - The Netherlands

Spot | Downlights & Spots

DOWNLIGHT SPOT | DIMMABLE | BLACK

The design of this downlight spot is just like a downlight, but like a spot, it has a reflector.



Input voltage: 220-240V
Power: 6/9 Watt
Driver: Internal dimmable driver included
Dimming method: Triac
UGR: <17
Beam angle: 40°
IP rate: IP44 (when mounted)
Mounting: Recessed
Connection type: Terminal block
Housing frame: Aluminium (thermal coated)
Housing color: Black



ART. NR.	POWER	LUMINOUS FLUX	COLOR TEMP.	LIGHT COLOR	DIAMETER	HEIGHT	MOUNTING HOLE
136-178	6 Watt	300 Lm	2200K	● Warm white++	Ø 81 mm	87,7 mm	Ø 68 mm
136-179	6 Watt	370 Lm	2700K	● Warm white+	Ø 81 mm	87,7 mm	Ø 68 mm
136-103	6 Watt	400 Lm	3000K	● Warm white	Ø 81 mm	87,7 mm	Ø 68 mm
136-104	6 Watt	480 Lm	4000K	○ Natural white	Ø 81 mm	87,7 mm	Ø 68 mm
136-191	9 Watt	460 Lm	2700K	● Warm white+	Ø 103 mm	90,7 mm	Ø 90 mm
136-107	9 Watt	500 Lm	3000K	● Warm white	Ø 103 mm	90,7 mm	Ø 90 mm
136-108	9 Watt	500 Lm	4000K	○ Natural white	Ø 103 mm	90,7 mm	Ø 90 mm

DOWNLIGHT SPOT | DIMMABLE | WHITE

The design of this downlight spot is just like a downlight, but like a spot, it has a reflector.



Input voltage: 220-240V
Power: 6/9 Watt
Driver: Internal dimmable driver included
Dimming method: Triac
UGR: <17
Beam angle: 40°
IP rate: IP44 (when mounted)
Mounting: Recessed
Connection type: Terminal block
Housing frame: Aluminium (thermal coated)
Housing color: White



ART. NR.	POWER	LUMINOUS FLUX	COLOR TEMP.	LIGHT COLOR	DIAMETER	HEIGHT	MOUNTING HOLE
136-176	6 Watt	370 Lm	2200K	● Warm white++	Ø 81 mm	87,7 mm	Ø 68 mm
136-177	6 Watt	440 Lm	2700K	● Warm white+	Ø 81 mm	87,7 mm	Ø 68 mm
136-101	6 Watt	470 Lm	3000K	● Warm white	Ø 81 mm	87,7 mm	Ø 68 mm
136-102	6 Watt	480 Lm	4000K	○ Natural white	Ø 81 mm	87,7 mm	Ø 68 mm
136-190	9 Watt	580 Lm	2700K	● Warm white+	Ø 103 mm	90,7 mm	Ø 90 mm
136-105	9 Watt	600 Lm	3000K	● Warm white	Ø 103 mm	90,7 mm	Ø 90 mm
136-106	9 Watt	650 Lm	4000K	○ Natural white	Ø 103 mm	90,7 mm	Ø 90 mm

TRIAC LED DIMMERS

ART. NR.	POWER
215-131	2W - 350W
215-135	2X 2W - 100W

Downlights & Spots

DOWNLIGHT 3-CCT PRESETTABLE

With CCT switch for pre-settable color temperature 3000K - 4000K - 6000K and pre-settable powerswitch on the external driver (two power settings).



- Input voltage:** 220-240V
- Power:** 7~10/10~14/12~18/14~20/21~30 Watt
- Driver:** External Class A driver Eaglerise (non-dimmable) included
- Dimmable:** Optional
- Beam angle:** 90°
- IP rate:** IP44 (when mounted)
- Mounting:** Recessed
- Cable length:** 120 cm
- Connection type:** Europlug
- Housing frame:** Aluminium
- Housing color:** White



ART.NR.	MAX. POWER	MAX. LUMINOUS FLUX	LIGHT COLOR	DIAMETER	HEIGHT	MOUNTING HOLE
136-122	10 Watt	850 Lm	3-CCT	Ø 113 mm	57 mm	Ø 90-98 mm
136-124	14 Watt	1170 Lm	3-CCT	Ø 143 mm	61 mm	Ø 117-127 mm
136-125	18 Watt	1550 Lm	3-CCT	Ø 165 mm	63 mm	Ø 135-145 mm
136-126	20 Watt	1720 Lm	3-CCT	Ø 200 mm	68 mm	Ø 168-178 mm
136-129	20 Watt	2820 Lm	3-CCT	Ø 230 mm	75 mm	Ø 192-210 mm
136-130	30 Watt	3880 Lm	3-CCT	Ø 279 mm	94 mm	Ø 240-255 mm

DIMMABLE DRIVERS

POWER	TRIAC	1-10V	DALI	RF	ZIGBEE	CASAMBI
10 Watt	215-280	215-601	215-272	214-184	214-260	215-295
14 Watt	215-280	215-601	215-272	214-184	214-261	215-295
18 Watt	215-280	215-601	215-267	214-184	214-261	215-295
20 Watt	215-281	215-601	215-267	214-184	214-261	215-295
30 Watt	215-282	215-602	215-605	214-184	-	215-296

Adjustable | Downlights & Spots

DOWNLIGHT ADJUSTABLE | ROUND

Pre-settable powerswitch on the external driver (five power settings).



- Input voltage:** 220-240V
- Power:** 6~10/6~15/18~30 Watt
- Driver:** External driver (non-dimmable) included
- Dimmable:** Optional
- UGR:** <19
- Beam angle:** 24°/45°
- IP rate:** IP20
- Mounting:** Recessed
- Cable length:** 200 cm
- Connection type:** Europlug
- Housing frame:** Aluminium/glass (white coated)



ART.NR.	MAX. POWER	MAX. LUMINOUS FLUX	COLOR TEMP.(CCT)	LIGHT COLOR	BEAM ANGLE	DIAMETER	HEIGHT	MOUNTING HOLE
136-330	10 Watt	900 Lm	3000K	● Warm white	24°	Ø 96 mm	68 mm	Ø 85 mm
136-331	10 Watt	1000 Lm	4000K	○ Natural white	24°	Ø 96 mm	68 mm	Ø 85 mm
136-332	15 Watt	1450 Lm	3000K	● Warm white	24°	Ø 145 mm	102 mm	Ø 120 mm
136-333	15 Watt	1550 Lm	4000K	○ Natural white	24°	Ø 145 mm	102 mm	Ø 120 mm
136-334	15 Watt	1480 Lm	3000K	● Warm white	45°	Ø 180 mm	128,5 mm	Ø 165 mm
136-336	15 Watt	1580 Lm	4000K	○ Natural white	45°	Ø 180 mm	128,5 mm	Ø 165 mm
136-335	30 Watt	3000 Lm	3000K	● Warm white	45°	Ø 180 mm	128,5 mm	Ø 165 mm
136-337	30 Watt	3300 Lm	4000K	○ Natural white	45°	Ø 180 mm	128,5 mm	Ø 165 mm

DIMMABLE DRIVERS

POWER	TRIAC	1-10V	DALI	RF	ZIGBEE	CASAMBI
10 Watt	215-205	215-601	215-272	214-184	214-260	215-295
15 Watt	215-380	215-601	215-267	214-184	214-261	215-295
30 Watt	215-282	215-602	215-605	214-184	-	215-296

PRE-settable powerswitch

NEW at Tronix! Most of the downlights are next to 'color-adjustable' (3-CCT), now also 'power-adjustable' by using a power switch on the included external driver. This way you'll always have a suitable downlight in your offering.

PRE-instelbaar vermogen

NIEUW bij Tronix! Het merendeel van onze downlights zijn nu naast kleur-instelbaar (3-CCT), ook vermogen-instelbaar d.m.v. een powerswitch op de bijgeleverde externe driver. Zo heb je altijd een geschikte downlight in je assortiment.

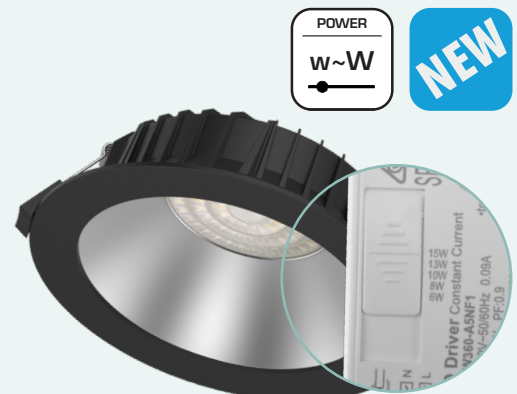

2 LED Panels

Setting quality standards for
functional lighting in work spaces





LED Panels | 60x60

LED PANEL 60X60 CM | 36W | 3-CCT | ENTRY LEVEL

“Entry level” flicker-free and professional LED panels with good light efficiencies and CCT switch for pre-settable color temperature 3000K - 4000K - 5700K.



Input voltage: 220-240V
Power: 36 Watt
Luminous flux: 3960/4090 Lm
Luminous efficiency: >110/120 Lm/W
Driver: External driver included (non-dimmable)
Beam angle: 120° / 90° UGR<19
IP rate: IP20
Length: 595 mm
Width: 595 mm
Height: 25 mm
Cable length: 200 cm
Connection type: Europlug
Housing frame: Aluminium (white coated)

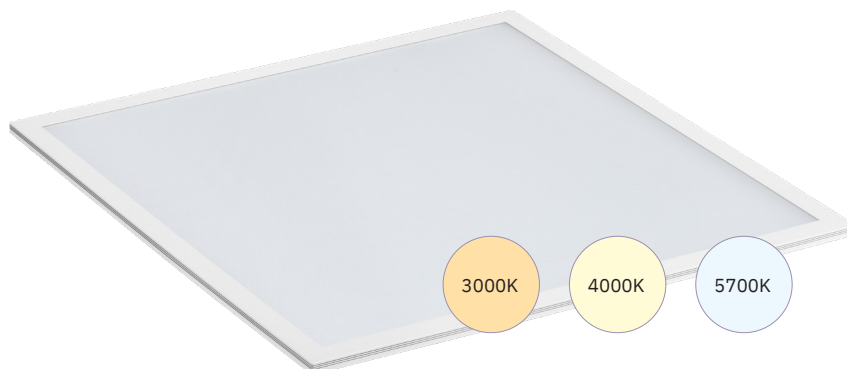

ART. NR.	SIZE	POWER	LUMINOUS FLUX	LM/WATT	UGR
173-052	60x60 cm	36 Watt	3960 Lm	110 Lm/W	19
173-050	60x60 cm	36 Watt	4090 Lm	120 Lm/W	22

LED PANEL 60X60 CM | 25W | 3-CCT | HIGH EFFICIENCY

Flicker-free and professional LED panels with perfect light efficiencies and CCT switch for pre-settable color temperature 3000K - 4000K - 5700K.



Input voltage: 220-240V
Power: 25 Watt
Luminous flux: 3790 Lm
Luminous efficiency: >150 Lm/W
Driver: External driver included (non-dimmable)
Beam angle: 120° / 90° UGR<19
IP rate: IP20
Length: 595 mm
Width: 595 mm
Height: 25 mm
Cable length: 200 cm
Connection type: Europlug/GST18i3
Housing frame: Aluminium (white coated)

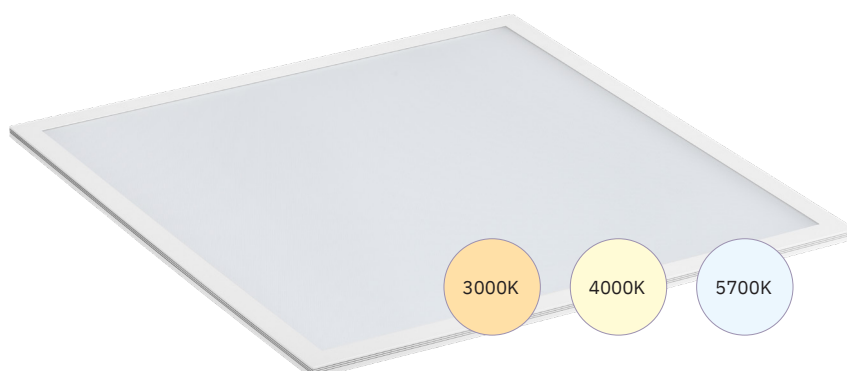

ART. NR.	SIZE	POWER	LUMINOUS FLUX	LM/WATT	UGR	PLUG
173-015	60x60 cm	25 Watt	3790 Lm	150 Lm/W	19	GST18i3
173-005	60x60 cm	25 Watt	3790 Lm	150 Lm/W	19	Europlug
173-006	60x60 cm	25 Watt	3790 Lm	150 Lm/W	22	GST18i3
173-016	60x60 cm	25 Watt	3790 Lm	150 Lm/W	22	Europlug

30x120 | LED Panels

LED PANEL 30X120 CM | 25W | 3-CCT | ENTRY LEVEL

“Entry level” flicker-free and professional LED panels with good light efficiencies and CCT switch for pre-settable color temperature 3000K - 4000K - 5700K.



Input voltage: 220-240V
Power: 36 Watt
Luminous flux: 3960/4090 Lm
Luminous efficiency: >110/120 Lm/W
Driver: External driver included (non-dimmable)
Beam angle: 120° / 90° UGR<19
IP rate: IP20
Length: 1195 mm
Width: 295 mm
Height: 25 mm
Cable length: 200 cm
Connection type: Europlug
Housing frame: Aluminium (white coated)

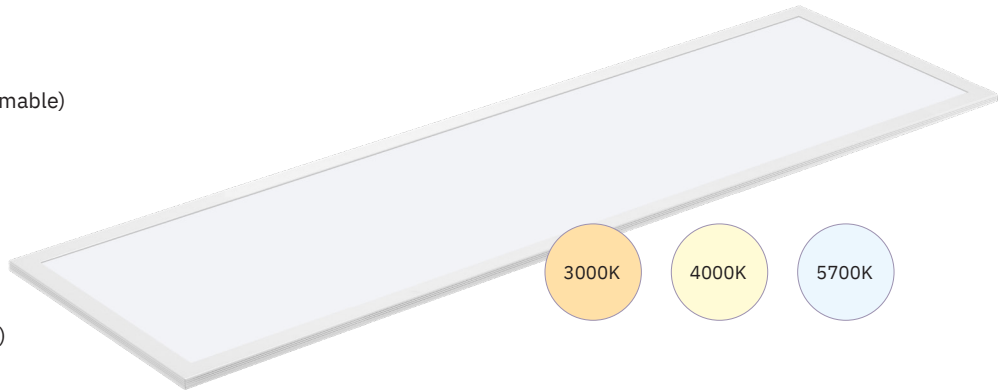

ART. NR.	SIZE	POWER	LUMINOUS FLUX	LM/WATT	UGR
173-053	30x120 cm	36 Watt	3960 Lm	110 Lm/W	19
173-051	30x120 cm	36 Watt	4090 Lm	120 Lm/W	22

LED PANEL 30x120 CM | 25W | 3-CCT | HIGH EFFICIENCY

Flicker-free and professional LED panels with perfect light efficiencies and CCT switch for pre-settable color temperature 3000K - 4000K - 5700K.



Input voltage: 220-240V
Power: 25 Watt
Luminous flux: 3790 Lm
Luminous efficiency: >150 Lm/W
Driver: External driver included (non-dimmable)
Beam angle: 120° / 90° UGR<19
IP rate: IP20
Length: 1195 mm
Width: 295 mm
Height: 25 mm
Cable length: 200 cm
Connection type: Europlug/GST18i3
Housing frame: Aluminium (white coated)

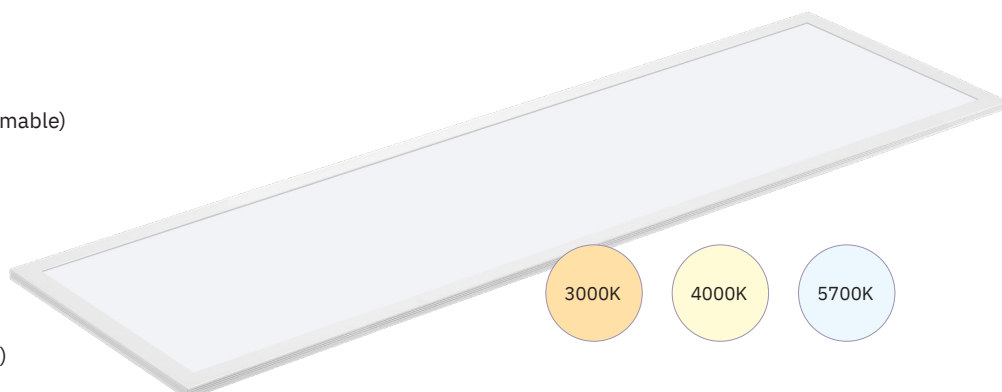

ART. NR.	SIZE	POWER	LUMINOUS FLUX	LM/WATT	UGR	PLUG
173-025	30x120 cm	25 Watt	3790 Lm	150 Lm/W	19	GST18i3
173-035	30x120 cm	25 Watt	3790 Lm	150 Lm/W	19	Europlug
173-036	30x120 cm	25 Watt	3790 Lm	150 Lm/W	22	GST18i3
173-026	30x120 cm	25 Watt	3790 Lm	150 Lm/W	22	Europlug

LED Panels | 60x60 | 30x120

LED PANEL 60X60 | 30x120 CM | 25W | 3-CCT | EXL. DRIVER

Flicker-free and professional LED panels with perfect light efficiencies and CCT switch for pre-settable color temperature 3000K - 4000K - 5700K. This panel is delivered excl. driver.



Input voltage: 220-240V
Power: 25 Watt
Luminous flux: 3790 Lm
Luminous efficiency: >150 Lm/W
Driver: Excluded
Beam angle: 120° / 90° UGR<19
IP rate: IP20
Length: 595 | 1195 mm
Width: 595 | 295 mm
Height: 25 mm
Housing frame: Aluminium (white coated)

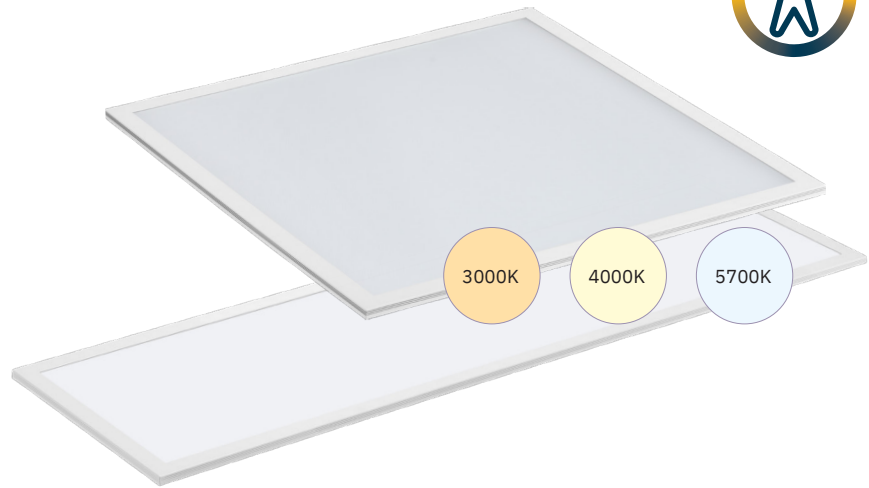

ART. NR.	SIZE	POWER	LUMINOUS FLUX	LM/WATT	UGR
173-001	60x60 cm	25 Watt	3790 Lm	150 Lm/W	19
173-002	60x60 cm	25 Watt	3790 Lm	150 Lm/W	22
173-021	30x120 cm	25 Watt	3790 Lm	150 Lm/W	19
173-022	30x120 cm	25 Watt	3790 Lm	150 Lm/W	22

Single color | tuneable white | Human Centric Lighting

Single color Use LED panel 173-001, 173-002, 173-021 or 173-022 in combination with:

	Connector set 173-096 Driver Europlug or GST plug	To connect with a driver Triac, DALI, 1-10V or RF dimmable driver (see our catalog 'light design & technology') set to 650 mA See page 41
---	---	---

Tuneable white Use LED panel 173-001, 173-002, 173-021 or 173-022 in combination with:

	Connector set 173-095 Driver Europlug or GST plug	To connect with a driver DALI or RF dimmable driver (see our catalog 'light design & technology') set to 650 mA See page 41
---	---	---

Human Centric Lighting Use LED panel 173-001, 173-002, 173-021 or 173-022 in combination with:

	Connector set 173-095 Driver Europlug or GST plug	To connect with a driver eldoLED Dual drive 215-269 and Casambi module 214-232 See page 41
---	---	--

LED PANEL 60X60 CM | 36W | RGBTW

Controllable LED panel RGB or tuneable white, RGBW+TW controller not included
(Art.nr. 214-166)



Input voltage: 24V
Power: 36 Watt (RGB full on or TW full on)
Driver: Not included
Dimmable: Yes
Beam angle: 120°
Length: 595 mm
Width: 595 mm
Height: 25 mm
IP rate: IP20
Cable length: 100 cm
Connection type: Stripped wire
Housing frame: Aluminium (white coated)

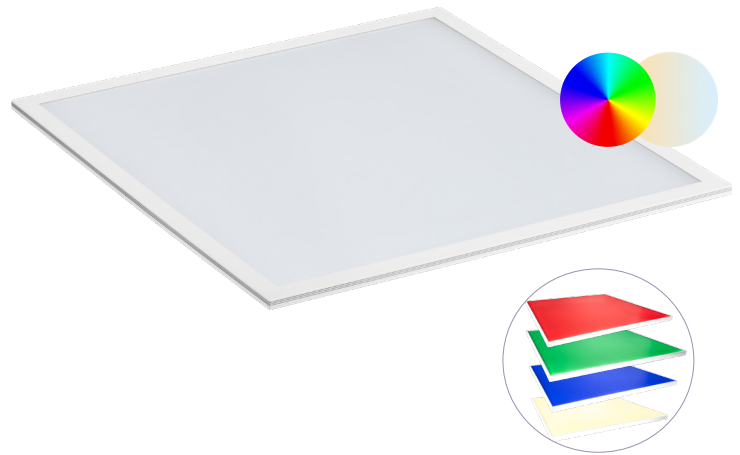

ART. NR.	POWER	LIGHT COLOR	COLOR TEMP. (CCT)
173-048	36 Watt	RGBTW	RGB or 2700K ~ 6500K

ART. NR.	CONTROLLER/RECEIVER
214-178	RGB+TW remote control RF 4 zones
214-166	RGB+TW controller 12V ~ 36V 5*5A



Human Centric Lighting

'Following the interest in high quality lighting, healthy lighting in the workplace is also getting more attention. Human Centric Lighting, or biodynamic lighting, is one of the key trends'

The idea behind this lighting technique? Light has an undeniable influence on our daily rhythm and well-being. The gradual change from light to dark not only controls our biological clock, but also affects our health, mood and productivity. This cycle can be supported by artificial lighting, for example by gradually transitioning from cold (6000 Kelvin) to warm white+ (2700 Kelvin) during the day. Just like real daylight. Biodynamic lighting helps employees getting their day off to a more energetic start. At the end of the day, they go home relaxed, sleep better and start the next work day well-rested.

Tronix Lighting is HCL-supportive with a tuneable panel, Art.nr. 173-002 with eldoLED DUALdrive Art.nr. 215-269 and Casambi module Art.nr. 214-232. HCL-ready products are marked with a matching icon.



Human Centric Lighting

'In navolging van goed licht, groeit ook de belangstelling van gezond licht op de werkvloer. Hierbij is een belangrijke rol weggelegd voor Human Centric Lighting (of: biodynamische verlichting)'

Het idee achter deze verlichtingstechniek is dat licht een onmiskenbare invloed heeft op ons dagritme én ons welbevinden. De geleidelijke wisseling van licht naar donker stuurt niet alleen onze biologische klok aan, maar heeft ook invloed op onze gezondheid, ons humeur en onze productiviteit. Kunstlicht kan hier bijvoorbeeld in ondersteunen door gedurende de dag en heel geleidelijk over te schakelen van koud (6000 Kelvin) naar warm wit + (2700 Kelvin). Net als echt daglicht. Dankzij biodynamische verlichting beginnen medewerkers aantoonbaar energiever en aan hun dag. Bovendien gaan zij ontspannen naar huis, waardoor zij beter slapen en uitgerust aan de volgende werkdag kunnen beginnen.

Tronix Lighting draagt hieraan bij met een tuneable paneel, bijvoorbeeld Art.nr. 173-002 met eldoLED DUALdrive Art.nr. 215-269 en Casambi module Art.nr. 214-232 HCL-ready producten zijn gemarkeerd met een gelijknamig icoon.



Conference room with Tronix LED panels 3-CCT UGR <17
Art.nr 174-270, van Tienen Zeeland - The Netherlands

Specials | LED Panels

LED PANEL | 60X60 CM | 3-CCT | 130 Lm/W | UGR<17

LED panel with CCT switch for pre-settable color temperature 3000K - 4000K - 5700K
Choice in black or white frame. Also available in tuneable white. Ask us for more information.



- Input voltage:** 220-240V
- Power:** 27 Watt
- Luminous flux:** >3510 Lm
- Luminous efficiency:** >130 Lm/W
- Driver:** External driver included (non-dimmable)
- Dimmable:** Optional, check our website for dimmable drivers
- Beam angle:** 70°
- IP rate:** IP20
- Length:** 595 mm
- Width:** 595 mm
- Height:** 16 mm
- Cable length:** 200 cm
- Connection type:** Europlug
- Housing frame:** Aluminium (coated)

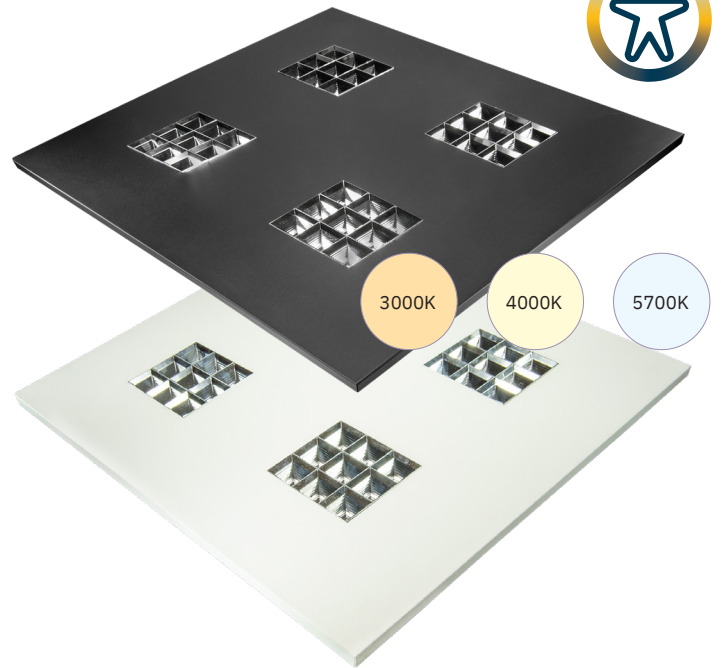

ART. NR.	FRAME COLOR
174-271	● Black frame
174-270	○ White frame

LED PANEL | BUTTERFLY | 3-CCT | UGR<19

LED panel with CCT switch for pre-settable color temperature 3000K - 4000K - 5700K.
Triac dimmable.



- Input voltage:** 220-240V
- Power:** 36 Watt
- Luminous flux:** 3000~3600 Lm
- Luminous efficiency:** >100 Lm/W
- Driver:** External driver included
- Dimmable:** Yes, Triac
- Beam angle:** 90°
- IP rate:** IP20
- Length:** 595 mm / 1195 mm
- Width:** 595 mm / 295 mm
- Height:** 49 mm
- Cable length:** 200 cm
- Connection type:** Europlug
- Housing frame:** Aluminium (coated)

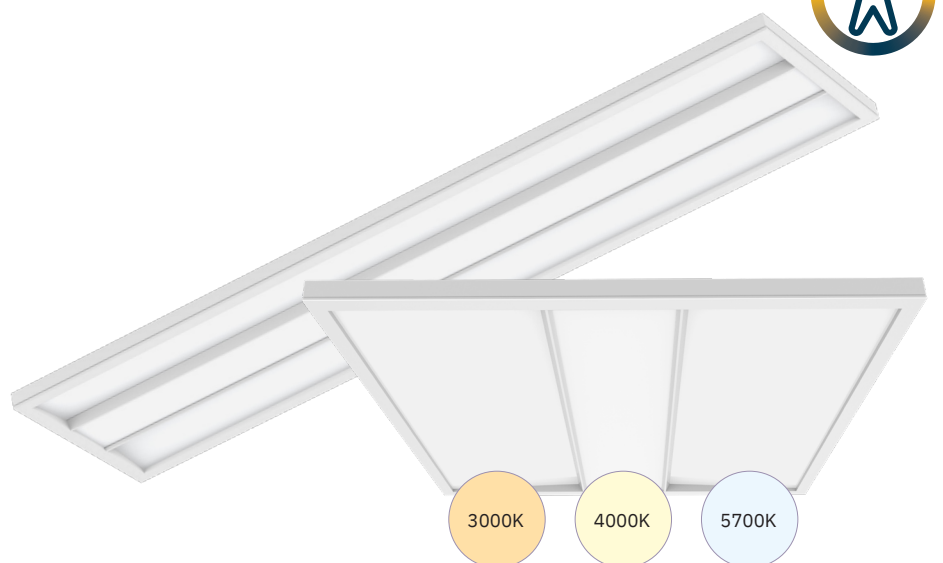

ART. NR.	LENGTH	WIDTH	HEIGHT
174-275	595 mm	595 mm	49 mm
174-276	1195 mm	295 mm	49 mm



Tronix Panels 60x60 at office building, Jaleco Totaalafbouw - The Netherlands

Other sizes | LED Panels

LED PANEL 30X60 CM | 3-CCT | >100 LM/W

With CCT switch for pre-settable color temperature 3000K - 4000K - 6000K.



Input voltage: 220-240V
Power: 18 Watt
Luminous flux: >1800 Lm
Luminous efficiency: >100 Lm/W
Driver: External driver included (non-dimmable)
Dimmable: Optional, check our website for optional dimmable drivers
Beam angle: 120°
IP rate: IP20
Length: 595 mm
Width: 295 mm
Height: 11 mm
Cable length: 200 cm
Connection type: Europlug
Housing frame: Aluminium (white coated)

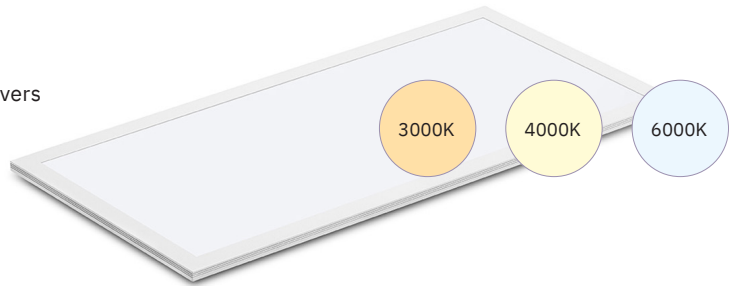

ART.NR.	POWER	LUMINOUS FLUX	LIGHT COLOR
174-029	18 Watt	>1800 Lm	3-CCT

LED PANEL 60X120 CM | 3-CCT | >100 LM/W

With CCT switch for pre-settable color temperature 3000K - 4000K - 6000K.



Input voltage: 220-240V
Power: 48 Watt
Luminous efficiency: >100 Lm/W
Driver: External driver included (non-dimmable)
Dimmable: Optional, check our website for optional dimmable drivers
Beam angle: 120°
IP rate: IP20
Length: 1195 mm
Width: 595 mm
Height: 11 mm
Cable length: 200 cm
Connection type: Europlug
Housing frame: Aluminium (white coated)

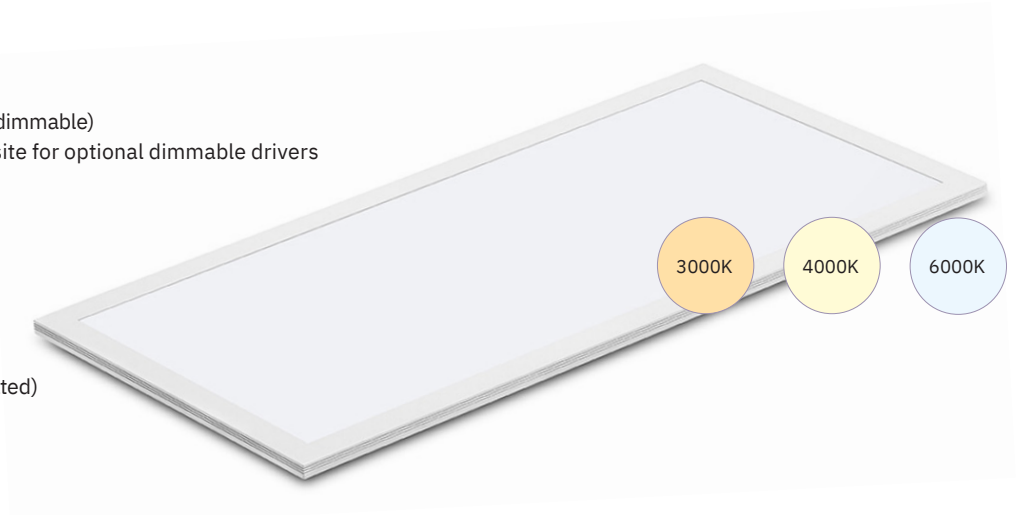

ART.NR.	POWER	LUMINOUS FLUX	LIGHT COLOR
174-237	48 Watt	>4800 Lm	3-CCT

LED Panels | Accessories

SURFACE MOUNTING KIT FOR LED PANELS | WHITE

ART. NR.	LENGTH	WIDTH	HEIGHT
173-101	600 mm	600 mm	58 mm
173-103	1200 mm	300 mm	58 mm
174-105	600 mm	300 mm	40 mm
174-106	1200 mm	600 mm	40 mm



SURFACE MOUNTING KIT FOR LED PANELS | BLACK

ART. NR.	LENGTH	WIDTH	HEIGHT
174-107	600 mm	600 mm	40 mm



SUSPENSION KIT FOR LED PANELS | MAX. 200 CM

Suitable for 60x60 or 30x120 cm LED panels



ART. NR.	WIRE QUANTITY	LED PANEL SIZE
173-100	4 pcs	60x60 or 30x120 cm

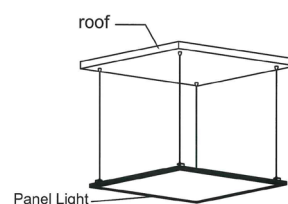

RECESSED CLIPS FOR LED PANELS

For 60*60 cm and 30*120 cm LED panels



ART. NR.	QUANTITY
173-110	4 pcs

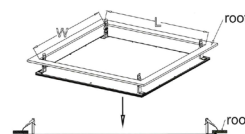

LED EMERGENCY PACK | 10-60V | 70mA | AUTO TEST

To convert LED panels, downlights or other ceiling lights into luminaires with an emergency function. See P.89 for more specs.



ART. NR.	SIZE	OPERATING TIME
600-028	145 x 36,8 x 23,5 mm	Min. 3 hrs.



Accessories | LED Panels

IR MOTION SENSOR | CEILING | RECESSED | IP20

Recessed infra-red motion sensor for suspended ceilings. Use 595-039 for easy connecting to LED panels.



Input voltage: 220V -240V

Time delay: 10 sec. - 15 min. (adj.)

Detection motion speed: 0,6 - 1,5 m/sec

Installation Height: 2,2 - 4m

Size: Ø76 mm (mount. size Ø61,5x75,6 mm)

IP rate: IP20

Connection type: Terminal block



ART. NR.	DETECTION RADIUS	OPERATING TIME	DETECTION DISTANCE	AMBIENT LIGHT
214-051	360°	300 Watt	Max. 6 meter	3-2000 Lux (adj.)

CONNECTOR SET

For connector set tuneable white (TW) or single color (SC) LED panels 25W



ART. NR.	CONNECTOR TYPE
173-095	Tuneable white (TW) 25W LED panel
173-096	Single color (SC) 25W LED panel



POWER CABLE | 1,5 METER

With stripped wire, with or without RA



ART. NR.	TYPE
595-021	Without RA 2 Wire
595-022	With RA 3 Wire



GST18/3 ACCESSORIES



ART. NR.	CONNECTION TYPE
595-040	Plug male
595-036	Powercable 3 meter
595-035	Extension cable 2 meter
595-037	Extension cable 3 meter
595-034	T-connector
595-030	Male to female Schuko
595-033	Male to female EU plug
595-039	Easy connecting sensor stripped wire
595-042	With stripped wire 0,3 meter
595-038	With stripped wire 1 meter



595-040



595-036



595-035/595-037



595-034



595-030



595-033



595-039



595-042/ 595-038

3 Ceiling & Wall Lights

Large choice in lighting solutions
for walls and ceilings





Ceiling & Wall Lights | Ceiling Lights

CEILING LIGHT ROUND | 3-CCT | 12/18W | IP54

With CCT switch for pre-settable color temperature 3000K - 4000K - 5700K.



Input voltage: 230V
Power: 12/18 Watt
Dimmable: No/Yes
Beam angle: 120°
IP rate: IP54
IK rate: IK08
Connection type: Terminal block
Material: PC



ART.NR.	POWER	LUMINOUS FLUX	LIGHT COLOR	DIAMETER	HEIGHT	DIMMABLE	MOTION SENSOR
136-042	12W	1200 Lm	3-CCT	Ø 300 mm	58 mm	No	No
136-040	18W	1850 Lm	3-CCT	Ø 300 mm	58 mm	Yes	No
136-041	18W	1850 Lm	3-CCT	Ø 300 mm	58 mm	No	Yes

CEILING LIGHT ROUND | 3-CCT | 15W | IP65

With CCT switch for pre-settable color temperature 3000K - 4000K - 5700K.



Input voltage: 230V
Power: 15 Watt
Dimmable: No
Beam angle: 110°
IP rate: IP65
IK rate: IK08
Connection type: Terminal block
Material: PC (white)



ART.NR.	POWER	LUMINOUS FLUX	LIGHT COLOR	DIAMETER	HEIGHT	EMERGENCY
136-043	15W	1270-1420 Lm	3-CCT	Ø 300 mm	60 mm	No
136-044	15W	1270-1420 Lm	3-CCT	Ø 300 mm	60 mm	Yes

CEILING LIGHT ROUND | 3-CCT | 15W | IP65

With CCT switch for pre-settable color temperature 3000K - 4000K - 5700K.



Input voltage: 230V
Power: 15 Watt
Dimmable: No
Beam angle: 110°
IP rate: IP65
IK rate: IK08
Connection type: Terminal block
Material: PC (black)



ART.NR.	POWER	LUMINOUS FLUX	LIGHT COLOR	DIAMETER	HEIGHT	EMERGENCY
136-045	15W	1270-1420 Lm	3-CCT	Ø 300 mm	60 mm	No
136-046	15W	1270-1420 Lm	3-CCT	Ø 300 mm	60 mm	Yes

Ceiling Lights | Ceiling & Wall Lights

CEILING LIGHT | 3-CCT | 8/12W | IP20

With CCT switch for pre-settable color temperature 3000K - 4000K - 5700K.



Input voltage: 230V
Power: 8/12 Watt
Dimmable: No
Beam angle: 120°
IP rate: IP20
IK rate: IK02
Connection type: Terminal block
Housing material: Aluminium & PC



ART. NR.	POWER	LUMINOUS FLUX	LIGHT COLOR	DIAMETER	HEIGHT	MOTION SENSOR
136-006	8 Watt	750 Lm	3-CCT	Ø 180 mm	70 mm	No
136-002	12 Watt	924 Lm	3-CCT	Ø 280 mm	95 mm	No
136-003	12 Watt	924 Lm	3-CCT	Ø 280 mm	95 mm	Yes

CEILING DOWNLIGHT | 3-CCT | 12/18W | IP44

This multifunctional ceiling lamp can be used for both recessed and surface mounting. In addition, it can be pre-set to power (12W / 18W) and light color (3000K - 4000K - 6000K).



Input voltage: 220-240V
Power: 12/18 Watt (pre-settable)
Dimmable: No
Beam angle: 110°
IP rate: IP44
IK rate: IK03
Connection type: Terminal block
Housing material: Aluminium & PC

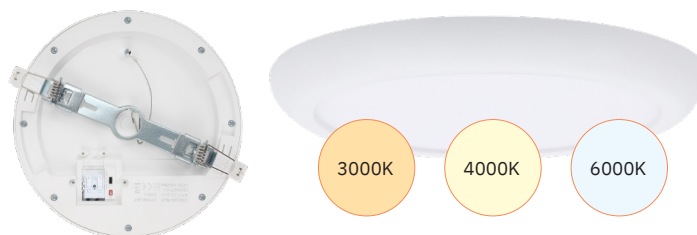

ART. NR.	POWER	LUMINOUS FLUX	LIGHT COLOR	DIAMETER	HEIGHT	MOUNTING HOLE
136-221	12/18 Watt	900/1350 Lm	3-CCT	Ø 280 mm	20,5 mm	Ø 120-200 mm

CEILING LIGHT | 2-CCT | 5/10W | IP44

This ceiling light features high quality LED chips combined with a microwave sensor that can be set as desired. This sensor is able to detect motion in detail, even through glass or thin walls.



Input voltage: 220-240V
Power: 5/10 Watt (switch)
Dimmable: No
Beam angle: 360° (ceiling) 150° (wall)
IP rate: IP44
IK rate: IK10
Connection type: Terminal block
Housing material: PC



ART. NR.	POWER	LUMINOUS FLUX	LIGHT COLOR	DIAMETER	HEIGHT
136-222	5/10W	1100/550 Lm	3-CCT	Ø 283 mm	90 mm

Ceiling & Wall Lights | Wall Lights

WALL LIGHT | 7W | IP65 | 2-CCT

With CCT switch for pre-settable color temperature 2700K - 3000K.



Input voltage: 220-240V
Power: 7 Watt
Dimmable: No
Beam angle: 120°
IP rate: IP65
IK rate: IK08
Connection type: Terminal block
Material: PC/Aluminium



ART.NR.	POWER	LUMINOUS FLUX	LIGHT COLOR	SIZE (L X W X H)	DIMMABLE	MOTION SENSOR
136-240	7 Watt	700 Lm	2-CCT	251 x 167 x 80 mm	No	No
136-241	7 Watt	700 Lm	2-CCT	251 x 167 x 80 mm	No	Yes

WALL LIGHT | 3W | IP65 | 2-CCT

With CCT switch for pre-settable color temperature 2700K - 3000K.



Input voltage: 220-240V
Power: 3/6 Watt
Dimmable: No
Beam angle: 120°
IP rate: IP65
IK rate: IK06
Connection type: Terminal block
Material: PC



ART.NR.	POWER	LUMINOUS FLUX	LIGHT COLOR	SIZE	DIMMABLE	MOTION SENSOR
136-250	3 Watt	200 Lm	2-CCT	∅ 125 mm	No	No
136-255	6 Watt	400 Lm	2-CCT	∅ 160 mm	No	No

Batten Lights | Ceiling & Wall Lights

BATTEN LIGHT | 2 SIZES | 20/40W | IP20 | 3-CCT

With CCT switch for pre-settable color temperature 3000K - 4000K - 5700K. Equipped with internal terminal block for wiring in and out.



Input voltage: 220-240V

Power: 20/40 Watt

Dimmable: No

Beam angle: 120°

IP rate: IP20

IK rate: IK08

Connection type: Terminal block

Housing material: Aluminium & PC

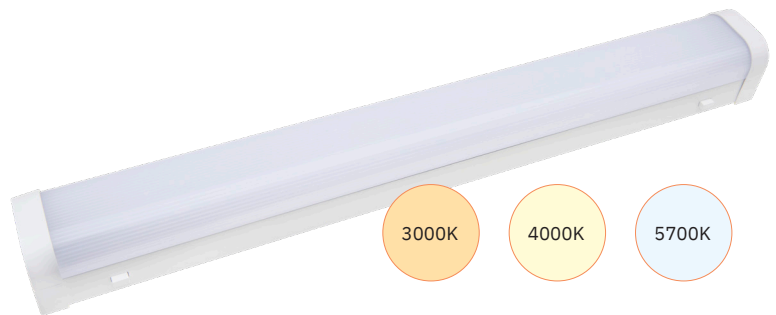

ART. NR.	POWER	LUMINOUS FLUX	LIGHT COLOR	LENGTH	WIDTH	HEIGHT
136-300	20 Watt	1800 - 2200 Lm	3-CCT	603 mm	71 mm	64 mm
136-301	40 Watt	4000 - 4600 Lm	3-CCT	1203 mm	71 mm	64 mm

BATTEN LIGHT | 600MM | 10~25W | IP20 | 3-CCT

With DIP switch for pre-settable power 10~25W and CCT switch for pre-settable color temperature 3000K - 4000K - 5700K. Equipped with internal terminal block for wiring in and out.



Input voltage: 220-240V

Power: 10~25 Watt

Dimmable: No

Beam angle: 120°

IP rate: IP20

IK rate: IK08

Connection type: Terminal block

Housing material: Aluminium & PC

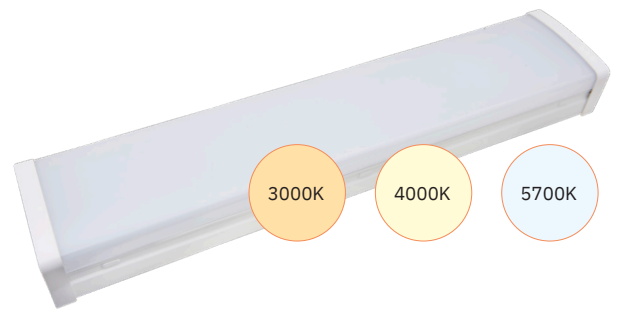

ART. NR.	POWER	LUMINOUS FLUX	LIGHT COLOR	LENGTH	WIDTH	HEIGHT
136-305	10~25 Watt	1050~2500 Lm	3-CCT	600 mm	124 mm	68 mm

BATTEN LIGHT FLAT | 2 SIZES | 18/30W | IP20 | 3-CCT

With CCT switch for pre-settable color temperature 3000K - 4000K - 5700K.



Input voltage: 200-240V

Power: 18/30 Watt

Dimmable: No

Beam angle: 120°

IP rate: IP20

IK rate: IK06

Connection type: Stripped wire

Power cable: 60 cm (on the back of the fixture)

Housing material: PC

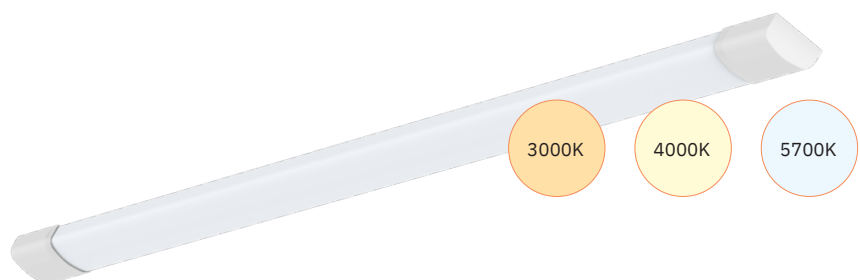

ART. NR.	POWER	LUMINOUS FLUX	LIGHT COLOR	LENGTH	WIDTH	HEIGHT
136-310	18 Watt	1450 - 1750 Lm	3-CCT	690 mm	56,5 mm	27,5 mm
136-311	30 Watt	3100 - 3400 Lm	3-CCT	1200 mm	56,5 mm	27,5 mm



Office space with Heartfelt® ceiling system and Light Bars, Art.nr. 179-024

HeartFelt® | Ceiling & Wall Lights

HEARTFELT® LIGHT BAR | REFLECTOR/OPAL

Especially developed for the HeartFelt® Modular and Acoustic Ceiling system. In 3000K or 4000K with reflector or opal cover, flicker-free triac or DALI dimmable driver excluded.



Input voltage: 200-240V

Power: 38/41W

Dimmable: Yes

Beam angle: : 70° x 70° (reflector) 120° (opal)

Color temperature: 3000K/4000K

IP rate: IP20

Connection type: Connector

Housing material: Aluminium/PC



ART. NR.	TYPE	POWER	LUMINOUS FLUX	COLOR TEMP. (CCT)	LIGHT COLOR	LENGTH	WIDTH	HEIGHT
179-002	Reflector	38 Watt	3900 Lm	3000K	● Warm white	1375 mm	40 mm	35 mm
179-004	Reflector	38 Watt	3900 Lm	4000K	○ Natural white	1375 mm	40 mm	35 mm
179-022	Opal	41 Watt	3600 Lm	3000K	● Warm white	1375 mm	40 mm	35 mm
179-024	Opal	41 Watt	3600 Lm	4000K	○ Natural white	1375 mm	40 mm	35 mm

ACCESSORIES

ART. NR.	TYPE
179-061	Phase-Cut dim driver for ceiling light bar Wieland 3P connector
179-060	Dali driver for ceiling light bar Wieland 5P connector
179-050	Coupler for ceiling light bar
179-080	Mounting brackets 2pcs ceiling light bar HeartFelt 40HL55
179-081	Mounting brackets 2pcs ceiling light bar HeartFelt 40HL80
179-082	Mounting brackets 2pcs ceiling light bar HeartFelt 40HL105



Art.nr. 179-061



Art.nr. 179-060



Art.nr. 179-050



Art.nr. 179-080, 179-081, 179-082

Especially developed for HeartFelt® ceilings

The Tronix 'Ceiling light bar' is especially developed for Hunter Douglas HeartFelt® Modular and Acoustic Ceiling System: an advanced system for architects, installers and building owners that delivers the right acoustics in every single room, setting or environment.

This sophisticated 'light bar' can easily be attached to the HeartFelt® ceiling carrier system with matching mounting brackets to hold them in place. They can be applied in one single line, in a more playful way, or just in the most efficient way possible.

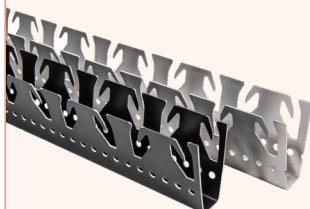

*The lightbar can be easily attached to any existing HeartFelt® ceiling carrier system with mounting brackets to hold them in place.

Speciaal ontwikkeld voor HeartFelt® plafonds

De armaturen voor HeartFelt plafonds zijn speciaal ontwikkeld voor het Hunter Douglas HeartFelt® Modulaire en akoestisch plafondsysteem: een geavanceerd systeem voor architecten, installateurs en gebouw-eigenaren dat in elke ruimte, setting of omgeving de juiste akoestiek levert.

Dit armatuur kan eenvoudig worden bevestigd aan het HeartFelt® plafonddragersysteem met montagebeugels om ze op hun plaats te houden. De armaturen kunnen in één lijn worden toegepast, op een meer speelse manier, of juist op de meest efficiënte manier.

Ceiling & Wall Lights | Ceiling Lights

DOWNLIGHT SURFACE | 3-CCT | DIMMABLE

With CCT switch for pre-settable color temperature 3000K - 4000K - 5700K.



Input voltage: 200-240V

Dimming method: Triac

Beam angle: 90°

IP rate: IP20

Connection type: Terminal block

Housing material: Aluminium

Housing color: Black or white



ART.NR.	HOUSING COLOR	POWER	LUMINOUS FLUX	LIGHT COLOR	DIAMETER	HEIGHT
136-097	● Black	13 Watt	1050-1260-1170 Lm	3-CCT	Ø 143 mm	112 mm
136-096	○ White	13 Watt	1050-1260-1170 Lm	3-CCT	Ø 143 mm	112 mm
136-099	● Black	18 Watt	1440-1670-1530 Lm	3-CCT	Ø 170 mm	124 mm
136-098	○ White	18 Watt	1440-1670-1530 Lm	3-CCT	Ø 170 mm	124 mm

TRIAC LED DIMMERS

ART NR.	POWER
215-131	2W - 350W
215-135	2X 2W - 100W

3-CCT: always the right color

3-CCT lighting has a so-called CCT switch on the back, that allows you to pre-set the lamp in three different light colors: warm white, natural white and cold white. In this way, you can always choose the right light color for your application.

3-CCT: altijd de juiste kleur

3-CCT verlichting heeft aan de achterkant een zogeheten CCT-switch, waardoor de lamp in drie verschillende lichtkleuren ingesteld kan worden: warm wit, neutraal wit en koud wit. Zo kan de lichtkleur altijd naar behoefte worden ingesteld.





Downlight Art.nr. 136-097 at showroom 'Boley Haarden' Veghel, the Netherlands



Our successful Tronix Light Cube (Art.nr. 149-144) beautifully decorates design restaurant Twin Pancakes, Uden - The Netherlands

Wall Lights | Ceiling & Wall Lights

WALL LAMP | CUBE | UP & DOWN | 6W DIMMABLE

With two independently adjustable beam angles (0° to 120°).

Input voltage: 220-240V
Power: 6 Watt
Dimming method: Triac
Beam angle: 2 x 0° to 120° (independently adjustable)
IP rate: IP65
Connection type: Terminal block
Housing material: Aluminium
Housing color: Black, white or grey (RAL7016)



ART.NR.	HOUSING COLOR	POWER	LUMINOUS FLUX	COLOR TEMP. (CCT)	LIGHT COLOR	SIZE (L X W X H)
149-138	● Black	6 Watt	2 x 110 Lm	2300K	● Warm white++	100 x 100 x 101 mm
149-139	○ White	6 Watt	2 x 110 Lm	2300K	● Warm white++	100 x 100 x 101 mm
149-134	● Grey (RAL7016)	6 Watt	2 x 110 Lm	2300K	● Warm white++	100 x 100 x 101 mm
149-144	● Black	6 Watt	2 x 110 Lm	2700K	● Warm white+	100 x 100 x 101 mm
149-145	○ White	6 Watt	2 x 110 Lm	2700K	● Warm white+	100 x 100 x 101 mm
149-133	● Grey (RAL7016)	6 Watt	2 x 110 Lm	2700K	● Warm white+	100 x 100 x 101 mm
149-142	● Black	6 Watt	2 x 110 Lm	3000K	○ Warm white	100 x 100 x 101 mm
149-143	○ White	6 Watt	2 x 110 Lm	3000K	○ Warm white	100 x 100 x 101 mm
149-132	● Grey (RAL7016)	6 Watt	2 x 110 Lm	3000K	○ Warm white	100 x 100 x 101 mm

WALL LAMP | CUBE | UP & DOWN | 20W DIMMABLE

With two independently adjustable beam angles (0° to 120°).

Input voltage: 220-240V
Power: 20 Watt
Dimming method: Triac
Beam angle: 2 x 0° to 120° (independently adjustable)
IP rate: IP65
Connection type: Terminal block
Housing material: Aluminium
Housing color: Black



ART.NR.	HOUSING COLOR	POWER	LUMINOUS FLUX	COLOR TEMP. (CCT)	LIGHT COLOR	SIZE (L X W X H)
149-244	● Black	20 Watt	2 x 254 Lm	2700K	● Warm white+	200 x 100 x 101 mm
149-242	● Black	20 Watt	2 x 287 Lm	3000K	○ Warm white	200 x 100 x 101 mm

TRIAC LED DIMMERS

ART NR.	POWER
215-131	2W - 350W
215-135	2X 2W - 100W

Ceiling & Wall Lights | Wall Lights

WALL LAMP | ROUND | UP & DOWN | 6W DIMMABLE

With two independently adjustable beam angles (0° to 120°).

Input voltage: 220-240V

Power: 6 Watt

Dimming method: Triac

Beam angle: 2 x 0° to 120° (independently adjustable)

IP rate: IP65

Connection type: Terminal block

Housing material: Aluminium

Housing color: Black or white



ART.NR.	HOUSING COLOR	POWER	LUMINOUS FLUX	COLOR TEMP. (CCT)	LIGHT COLOR	SIZE (L X W X H)
149-148	● Black	6 Watt	2 x 110 Lm	2700K	● Warm white+	136 x 115 x 100 mm
149-149	○ White	6 Watt	2 x 110 Lm	2700K	● Warm white+	136 x 115 x 100 mm
149-146	● Black	6 Watt	2 x 110 Lm	3000K	○ Warm white	136 x 115 x 100 mm
149-147	○ White	6 Watt	2 x 110 Lm	3000K	○ Warm white	136 x 115 x 100 mm

WALL LAMP | DOWNLIGHT | 5,8W | 2700K DIMMABLE

Pyramid shaped downlight with a beam angle of 36°.

Input voltage: 220-240V

Power: 5,8 Watt

Dimming method: Triac

Beam angle: 36°

IP rate: IP65

Connection type: Terminal block

Housing material: Aluminium

Housing color: Black



ART.NR.	HOUSING COLOR	POWER	LUMINOUS FLUX	COLOR TEMP. (CCT)	LIGHT COLOR	SIZE (L X W X H)
149-170	● Black	5,8 Watt	640 Lm	2700K	● Warm white+	143 x 90 x 90 mm

Wall Lights | Ceiling & Wall Lights

WALL LAMP | UP- & DOWNLIGHT | 5,5W | 3000K NON-DIMMABLE



Up- and downlight with a beam angle of 25°, ultra small fixture; 100 mm.

Input voltage: 220-240V
Power: 5,5 Watt
Dimmable: No
Beam angle: 25°
IP rate: IP65
Connection type: Terminal block
Housing material: Aluminium
Housing color: Black



ART.NR.	HOUSING COLOR	POWER	LUMINOUS FLUX	COLOR TEMP. (CCT)	LIGHT COLOR	SIZE (L X W H)
149-160	● Black	5,5 Watt	2 x 161 Lm	3000K	○ Warm white	100x61x38 mm

WALL LAMP | UP- & DOWNLIGHT | 6,9/12,9W DIMMABLE



Black or white up- and downlight, with or without light diffuser.

Input voltage: 220-240V
Power: 6,9/12,9 Watt
Dimming method: Triac
Beam angle: 90°
IP rate: IP54
Connection type: Terminal block
Housing material: Aluminium
Housing color: Black or white



ART.NR.	HOUSING COLOR	POWER	LUMINOUS FLUX	COLOR TEMP. (CCT)	LIGHT COLOR	SIZE (L X W X H)	DIFFUSER
149-150	● Black	6,9 Watt	2 x 346 Lm	2700K	○ Warm white+	115 x 90 x 28 mm	No
149-151	○ White	6,9 Watt	2 x 346 Lm	2700K	○ Warm white+	115 x 90 x 28 mm	No
149-155	● Black	12,9 Watt	2 x 508 Lm	2700K	○ Warm white+	175 x 90 x 28 mm	No
149-156	○ White	12,9 Watt	2 x 508 Lm	2700K	○ Warm white+	175 x 90 x 28 mm	No
149-157	● Black	12,9 Watt	2 x 508 Lm	2700K	○ Warm white+	175 x 90 x 28 mm	Yes
149-158	○ White	12,9 Watt	2 x 508 Lm	2700K	○ Warm white+	175 x 90 x 28 mm	Yes

4

Track Light

Powerful light sources for efficient
lighting and natural looking
colors in retail and hospitality







Tronix Track Lights at home residence, Den Bosch - The Netherlands

Spots | Track Light

TRACK SPOT | 3-PHASE | 3-CCT | BLACK

With CCT switch for pre-settable color temperatures 2500K - 2700K - 3000K or 3000K - 3500K - 4000K. High heat dissipation through separate LEDs and driver.



Input voltage: 220-240V
Power: 8/20/30 Watt
Power factor: >0.90
LED qty: 1 pc
LED type: SMD
Dimmable: Yes
Beam angle: 40°
CRI value: >90
IP rate: IP20
Connection type: 3-phase adaptor



ART.NR.	HOUSING	POWER	LUMINOUS FLUX	COLOR TEMP. (CCT)	LIGHT COLOR	BEAM ANGLE	LENGTH	DIAMETER Ø
169-274	● Black	8 Watt	660 Lm	2500/2700/3000K	3-CCT	40°	125 mm	Ø 60 mm
169-276	● Black	8 Watt	660 Lm	3000/3500/4000K	3-CCT	40°	125 mm	Ø 60 mm
169-292	● Black	20 Watt	1600 Lm	3000/3500/4000K	3-CCT	40°	186 mm	Ø 80 mm
169-296	● Black	20 Watt	1600 Lm	2500/2700/3000K	3-CCT	40°	186 mm	Ø 80 mm
169-362	● Black	30 Watt	2500 Lm	3000/3500/4000K	3-CCT	40°	210 mm	Ø 90 mm

TRACK SPOT | 3-PHASE | 3-CCT | WHITE

With CCT switch for pre-settable color temperatures 2500K - 2700K - 3000K or 3000K - 3500K - 4000K. High heat dissipation through separate LEDs and driver.



Input voltage: 220-240V
Power: 8/20/30 Watt
Power factor: >0.90
LED qty: 1 pc
LED type: SMD
Dimmable: Yes
Beam angle: 40°
CRI value: >89
IP rate: IP20
Connection type: 3-phase adaptor



For more design options, every white track spot, comes with a white and black inner ring

ART.NR.	HOUSING	POWER	LUMINOUS FLUX	COLOR TEMP. (CCT)	LIGHT COLOR	BEAM ANGLE	LENGTH	DIAMETER Ø
169-275	○ White	8 Watt	660 Lm	2500/2700/3000K	3-CCT	40°	125 mm	Ø 60 mm
169-297	○ White	20 Watt	1600 Lm	2500/2700/3000K	3-CCT	40°	186 mm	Ø 80 mm
169-293	○ White	20 Watt	1600 Lm	3000/3500/4000K	3-CCT	40°	186 mm	Ø 80 mm
169-363	○ White	30 Watt	2500 Lm	3000/3500/4000K	3-CCT	40°	210 mm	Ø 90 mm

ART. NR.	ACCESORIES
169-279	60° reflector for 8W track spot
169-299	60° reflector for 20W track spot
169-369	60° reflector for 30W track spot



Track Light | Linear

TRACK SPOT | 3-PHASE | LINEAR | 16W | 3-CCT

With CCT switch for pre-settable color temperature 3000K - 4000K - 5700K. Dimmable.

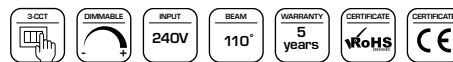

Input voltage: 220-240V
Power: 16 Watt
Power factor: >0.9
LED type: SMD
Dimmable: Yes
Beam angle: 110°
CRI value: >80
IP rate: IP20
Length: 650 mm
Width: 32,5 mm
Height: 52 mm
Connection type: 3-phase adaptor

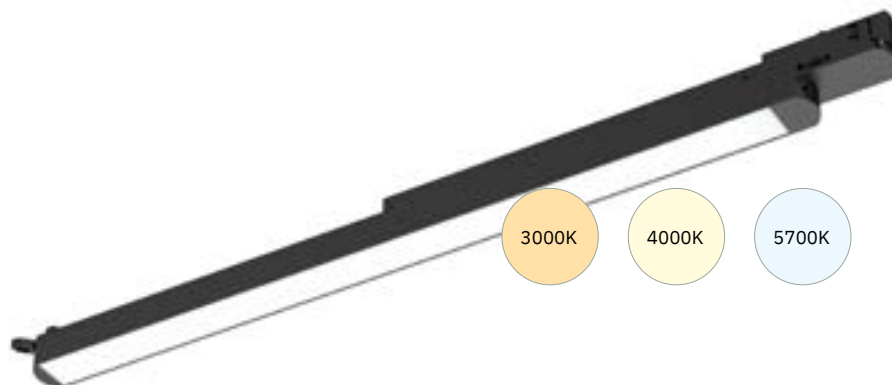

ART. NR.	HOUSING	POWER	LUMINOUS FLUX	COLOR TEMP. (CCT)	LIGHT COLOR
169-307	● Black	16 Watt	1547/1725/1620 Lm	3000K/4000K/5700K	Warm white/natural white/cold white
169-308	○ White	16 Watt	1547/1725/1620 Lm	3000K/4000K/5700K	Warm white/natural white/cold white

TRACK SPOT | 3-PHASE | LINEAR | 16W | 2700K/3000K

Linear track with reflector. Dimmable.



Input voltage: 100-240V
Power: 16 Watt
Power factor: >0.9
LED qty: 48 pcs
LED type: SMD2835
Dimmable: Yes
Beam angle: 60°x 70°
CRI value: >90
IP rate: IP20
Length: 650 mm
Width: 32 mm
Height: 52 mm
Connection type: 3-phase adaptor

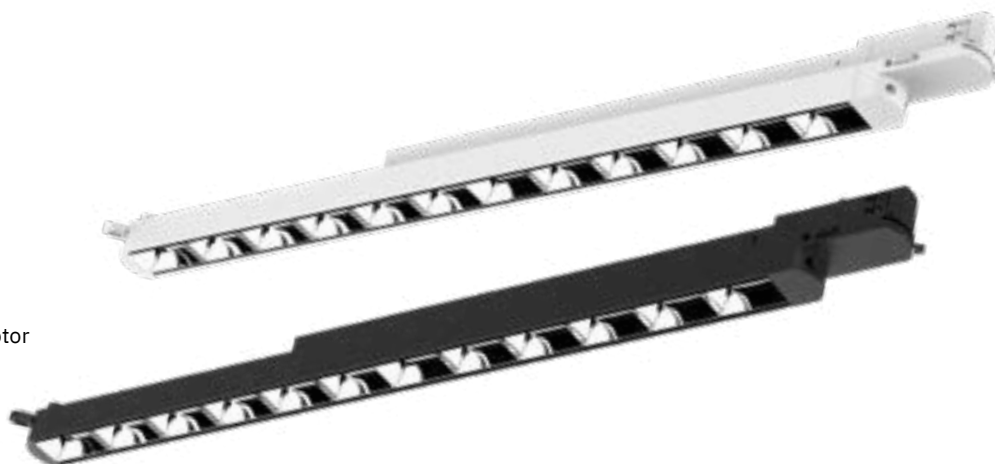

ART.NR	HOUSING	POWER	LUMINOUS FLUX	COLOR TEMP. (CCT)	LIGHT COLOR
169-313	● Black	16 Watt	1600 Lm	2700K	○ Warm white+
169-314	○ White	16 Watt	1600 Lm	2700K	○ Warm white+
169-310	● Black	16 Watt	1600 Lm	3000K	○ Warm white
169-311	○ White	16 Watt	1600 Lm	3000K	○ Warm white

Spots | Track Light

TRACK SPOT | 3-PHASE | GU10 | 50MM

With GU10 socket, for 50mm GU10 spots.

Lamp not included

Input voltage: 220-240V

Length: 222 mm

Length tube: 143 mm

Diameter: Ø 60 mm

IP rate: IP20

Connection type: 3-phase adaptor



Black



White

ART. NR.	HOUSING
169-153	● Black
169-152	○ White

ART. NR.	GU10 50MM TYPE
175-137	GU10 silver 5W 2700K 24° CRI>92
175-143	GU10 silver 5W 2700K 35° dimmable
175-142	GU10 silver 5W 2000~2700K 45° dim to warm CRI>97
175-144	GU10 silver 7W 2700K 35° dimmable



175-137



175-143



175-142



175-144

TRACK SPOT | 3-PHASE | GU10 | AR70

With GU10 socket, for AR70 GU10 spots.

Lamp not included

Input voltage: 220-240V

Length: 185 mm

Length tube: 116 mm

Diameter: Ø 80 mm

IP rate: IP20

Connection type: 3-phase adaptor



Black



White

ART. NR.	HOUSING
169-151	● Black
169-150	○ White

ART. NR.	GU10 AR70 TYPE
175-343	AR70 6 Watt 2700K 24° dimmable
175-344	AR70 6 Watt 2000-2700K 24° dim to warm
175-350	AR70 7 Watt 2000-2700K 36° dim to warm
175-347	AR70 6 Watt 3000K 24° dimmable



175-343, 175-344,
175-350, 175-347

See page 68-71 for more specifications

Track Light | 3-Phase Rail & Accessories

POWER CONNECTOR



ART. NR. COLOR
 169-042 ● Black
 169-007 ● Silver
 169-025 ○ White

ART. NR. COLOR
 169-043 ● Black
 169-026 ○ White

ENDCAP

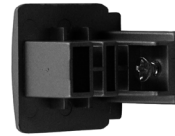

ART. NR. COLOR
 169-041 ● Black
 169-006 ● Silver
 169-024 ○ White

L-CONNECTOR

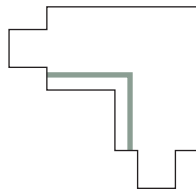
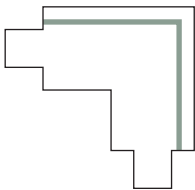

ART. NR. COLOR
 169-048 ● Black
 169-011 ● Silver
 169-031 ○ White

ART. NR. COLOR
 169-049 ● Black
 169-017 ● Silver
 169-032 ○ White

X-CONNECTOR



ART. NR. COLOR
 169-045 ● Black
 169-009 ● Silver
 169-028 ○ White

FLEXIBLE CONNECTOR

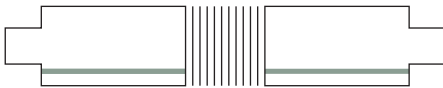

ART. NR. COLOR
 169-072 ● Black
 169-035 ○ White

INTERIOR CONNECTOR



ART. NR. COLOR
 169-040 ● Black
 169-005 ● Silver
 169-023 ○ White

3 PHASE ADAPTER

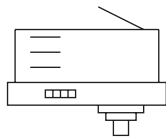

ART. NR. COLOR
 169-074 ● Black
 169-020 ● Silver
 169-037 ○ White

I-CONNECTOR



ART. NR. COLOR
 169-044 ● Black
 169-008 ● Silver
 169-027 ○ White

T-CONNECTOR

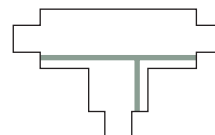
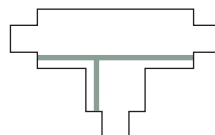
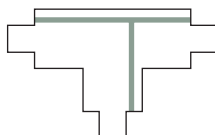
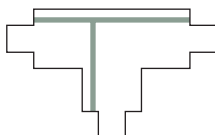

ART. NR. COLOR
 169-046 ● Black
 169-010 ● Silver
 169-029 ○ White

ART. NR. COLOR
 169-047 ● Black
 169-016 ● Silver
 169-030 ○ White

ART. NR. COLOR
 169-101 ● Black
 169-102 ● Silver
 169-103 ○ White

ART. NR. COLOR
 169-104 ● Black
 169-105 ● Silver
 169-106 ○ White

3-Phase Rail & Accessories | Track Light

EMERGENCY TRACKLIGHT

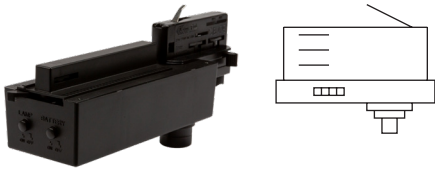

ART. NR.	COLOR	LUMINOUS FLUX
600-033	● Black	200 lm
600-034	○ White	200 lm

PENDING

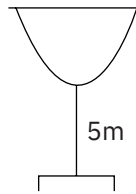

ART. NR.	COLOR
169-073	● Black
169-014	● Silver
169-036	○ White

SUSPENSION KIT

5m pendant with easyclick (to connect track rails quickly)



ART. NR.	COLOR
169-118	● Black

MOUNTING BRACKET

To connect rails screwless onto suspended ceilings



ART. NR.	COLOR
169-120	● Black
169-119	○ White

SURFACE MOUNTED FIXTURE



ART. NR.	COLOR
169-113	● Black
169-112	○ White

REINFORCEMENT PLATE



ART. NR.	COLOR
169-108	● Black
169-107	● Silver
169-109	○ White

3-PHASE TRACK RAIL



Rail 2 meter

ART. NR.	COLOR
169-038	● Black
169-002	● Silver
169-021	○ White

Rail 3 meter

ART. NR.	COLOR
169-039	● Black
169-003	● Silver
169-022	○ White

5 Recessed Fixtures

For elegant lighting
results in any ceiling





Recessed Fixtures | Trimless

RECESSED MOUNTING FIXTURE | 50MM | FULLY ADJUSTABLE

Delivered with fixed frame and trimless frame. To be used with 50 mm lamp (not included)



Housing: Black or white

Material: Iron, power coated

Use in combination with: 50 mm lamp, see page 68 and 69



ART. NR.	COLOR	MOUNTING HOLE RECESSED	SIZE - RECESSED (LXWXH)	SIZE - INCL. TRIMLESS FRAME (LXWXH)	FIXTURE TYPE
148-060	● Black	90 x 90 mm	119 x 119 x 100 mm	140 x 140 x 100 mm	Single
148-061	○ White	90 x 90 mm	119 x 119 x 100 mm	140 x 140 x 100 mm	Single
148-062	● Black	184 x 91 mm	219 x 119 x 102 mm	241 x 95 x 100 mm	Double
148-063	○ White	184 x 91 mm	219 x 119 x 102 mm	241 x 95 x 100 mm	Double

RECESSED MOUNTING FIXTURE | AR70 | FULLY ADJUSTABLE

Delivered with fixed frame and trimless frame. To be used with AR70 lamp (not included)



Housing: Black or white

Material: Iron, powder coated

Use in combination with: AR70 lamp (with GU10 socket), see page 70



ART. NR.	COLOR	MOUNTING HOLE RECESSED	SIZE - RECESSED (LXWXH)	SIZE - INCL. TRIMLESS FRAME (LXWXH)	FIXTURE TYPE
148-050	● Black	108 x 108 mm	137 x 137 x 100 mm	145 x 145 x 100 mm	Single
148-051	○ White	108 x 108 mm	137 x 137 x 100 mm	145 x 145 x 100 mm	Single
148-052	● Black	210 x 110 mm	240 x 137 x 100 mm	260 x 155 x 100 mm	Double
148-053	○ White	210 x 110 mm	240 x 137 x 100 mm	260 x 155 x 100 mm	Double

RECESSED MOUNTING FIXTURE | AR111 | FULLY ADJUSTABLE

Delivered with fixed frame and trimless frame. To be used with AR111 lamp (not included)



Housing: Black or white

Material: Iron, powder coated

Use in combination with: AR111 lamp, see page 71



ART. NR.	COLOR	MOUNTING HOLE RECESSED	SIZE - RECESSED (LXWXH)	SIZE - INCL. TRIMLESS FRAME (LXWXH)	FIXTURE TYPE
148-043	● Black	152 x 152 mm	192 x 192 x 100 mm	197 x 197 x 100 mm	Single
148-044	○ White	152 x 152 mm	192 x 192 x 100 mm	197 x 197 x 100 mm	Single
148-045	● Black	336 x 152 mm	375 x 192 x 100 mm	384 x 197 x 100 mm	Double
148-046	○ White	336 x 152 mm	375 x 192 x 100 mm	384 x 197 x 100 mm	Double



Tronix Trimless fixtures AR70 in a modern apartment, Nistelrode - The Netherlands



Recessed mounting fixtures in a modern kitchen, Uden - The Netherlands

Trimless Fixtures

1. Choose 'trimless' or 'recessed'

Tronix trimless fixtures are provided with both a recessed frame and a separate plaster frame. Choose recessed for a visible frame (fig.1) in ●○, or choose the plaster frame for a seamless ceiling without any visible outer frame (fig.2).



Fig 1. Recessed mounted



Fig 2. Trimless (invisible frame)

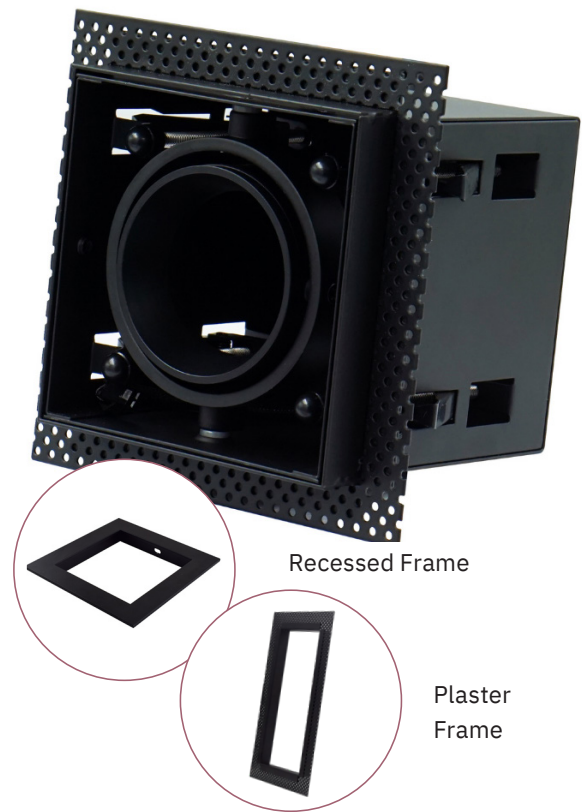

2. How to install

Installation of a recessed frame is easy: the luminaire can be mounted in the ceiling with mounting clips. In case of a plaster frame, the frame is attached behind a ceiling plate, after which the plate can be plastered.

3. Light source

Tronix trimless fixtures are suitable for \varnothing 50 mm, \varnothing 70 mm or \varnothing 111 mm spots. For matching spots, see P68-71

4. Fully adjustable

The fixtures are fully adjustable, making them ideal for atmospheric, homogeneous lighting results in any desired direction.



Scan for
installation
manual



Recessed Fixtures | Ø50 MM

Non Adjustable

Use in combination with:
Ø50 mm lamp, see page 68-69

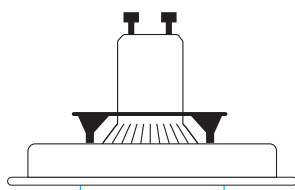

MODEL	1 hole plate round
DIMENSIONS	Ø 75 mm
MOUNTING	Ø 68 mm
ALUMINIUM	● 148-572
WHITE	○ 148-573
BLACK	● 148-582



MODEL	1 hole plate square
DIMENSIONS	85 x 85 mm
MOUNTING	Ø 70 mm
ALUMINIUM	● 148-578
WHITE	○ 148-579

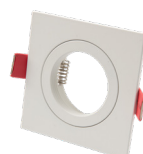

MODEL	1 hole plate square
DIMENSIONS	79 x 79 mm
MOUNTING	Ø 65 mm
ALUMINIUM	● 148-552
WHITE	○ 148-556



MODEL	1 hole plate round
DIMENSIONS	Ø 80 mm
MOUNTING	Ø 65 mm
ALUMINIUM	● 148-570
WHITE	○ 148-571



MODEL	1 hole plate round
DIMENSIONS	Ø 84 mm
MOUNTING	Ø 60 mm
ALUMINIUM	● 148-550
WHITE	○ 148-558
BLACK	● 148-585



MODEL	1 hole plate round
DIMENSIONS	Ø 85 mm
MOUNTING	Ø 70 mm
ALUMINIUM	● 148-576
WHITE	○ 148-577
BLACK	● 148-581



MODEL	1 hole plate round
DIMENSIONS	Ø 79 mm
MOUNTING	Ø 65 mm
ALUMINIUM	● 148-551
WHITE	○ 148-555
BLACK	● 148-586

Adjustable

Use in combination with:
Ø50 mm lamp, see page 68-69

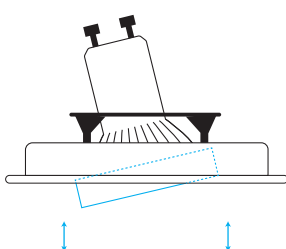

MODEL	1 hole plate round
DIMENSIONS	Ø 90 mm
MOUNTING	Ø 76 mm
WHITE	○ 148-565
BLACK	● 148-584



MODEL	1 hole plate round
DIMENSIONS	Ø 92 mm
MOUNTING	Ø 80 mm
ALUMINIUM	● 148-553
WHITE	○ 148-557
BLACK	● 148-563



MODEL	1 hole plate round
DIMENSIONS	Ø 83 mm
MOUNTING	Ø 72 mm
ALUMINIUM	● 148-507
WHITE	○ 148-569
BLACK	● 148-580



MODEL	1 hole plate square
DIMENSIONS	92 x 92 mm
MOUNTING	Ø 80 mm
ALUMINIUM	● 148-559
WHITE	○ 148-560
BLACK	● 148-583



MODEL	1 hole plate round
DIMENSIONS	Ø 75 mm
MOUNTING	Ø 68 mm
ALUMINIUM	● 148-574
WHITE	○ 148-575

AR70-AR111 | Recessed Fixtures

AR70 Plates - Adjustable

Use in combination with: AR70 lamp, see page 70

Size: Ø128 mm

Housing material: Aluminium

Housing color: Black, aluminium or white

ART. NR.	COLOR	MOUNTING HOLE	MOUNTING (HEIGT RECESSED)
148-026	● Aluminium	Ø 100 mm	25 mm
148-028	○ White	Ø 100 mm	25 mm
148-027	● Black	Ø 100 mm	25 mm

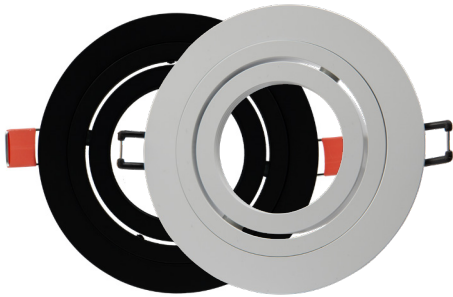
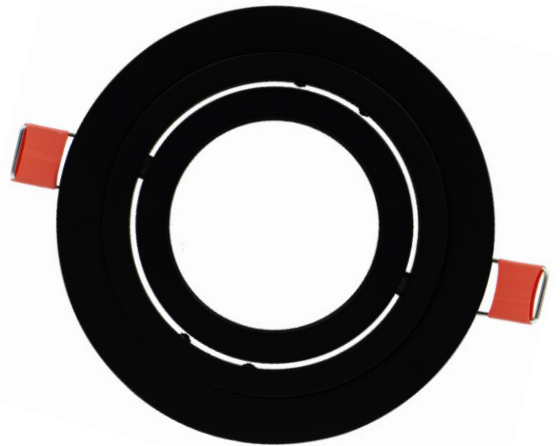

Available in black, white or aluminium.



Fits perfectly with 175-370/175-372 (black) or 175-343/175-347/175-344/175-350 (alu)

AR111 Plates - Adjustable

Use in combination with: AR111 lamp, see page 71

ART.NR.	MODEL	DIMENSIONS	MOUNTING
148-030	1 hole plate round AR111 - aluminium	Ø 180 mm	Ø 150 mm
148-033	1 hole plate round AR111 - white	Ø 180 mm	Ø 150 mm
148-036	1 hole plate round AR111 - black	Ø 180 mm	Ø 150 mm
148-031	1 hole plate square AR111 - aluminium	180 x 180 mm	Ø 150 mm
148-034	1 hole plate square AR111 - white	180 x 180 mm	Ø 150 mm
148-037	1 hole plate square AR111 - black	180 x 180 mm	Ø 150 mm
148-032	2 hole plate square AR111 - aluminium	355 x 180 mm	325 x 150 mm
148-035	2 hole plate square AR111 - white	355 x 180 mm	325 x 150 mm
148-038	2 hole plate square AR111 - black	355 x 180 mm	325 x 150 mm



Art. nr. 148-030



Art. nr. 148-033



Art. nr. 148-036

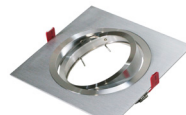

Art. nr. 148-031

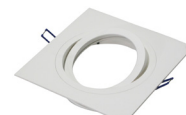

Art. nr. 148-034

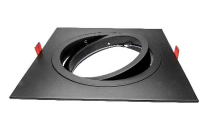

Art. nr. 148-037



Art. nr. 148-032



Art. nr. 148-035



Art. nr. 148-038

6

LED Light Sources

A complete range to suit any purpose and get great savings





LED Light Sources | Ø 50 mm Lamps

GU10 LED LAMP | 5 WATT COB

Replacement for 30W halogen spot.



Input voltage: 220-240V
Power: 5 Watt
LED type: COB
CRI value: >92
Dimmable: Yes (triac)

Beam angle: 24°
IP rate: IP20
Length: 60 mm
Diameter: Ø 50 mm
Housing: Aluminium/silver



ART. NR.	POWER	LUMINOUS FLUX	COLOR TEMP. (CCT)	LIGHT COLOR	DIMMABLE
175-137	5 Watt	250 Lm	2700K	○ Warm white+	Yes

Ø 50 MM LED SPOT | 5 WATT | 38° | 2700K | 2000K~2700K

Perfect substitute for all Ø50 mm GU10 Spots. A similar sized all performance with a height of only 26mm suitable in any ceiling application.



Input voltage: 220-240V
Power: 5 Watt
LED type: SMD
CRI value: >80
Dimmable: Yes <1% (triac)

Beam angle: 38°
IP rate: IP20
Height: 26 mm (31 mm with cable)
Diameter: Ø 50 mm
Housing: Black or white



ART. NR.	HOUSING COLOR	POWER	LUMINOUS FLUX	COLOR TEMP. (CCT)	LIGHT COLOR	DIMMABLE
175-570	● Black	5 Watt	400 Lm	2700K	○ Warm white+	Yes
175-550	○ White	5 Watt	400 Lm	2700K	○ Warm white+	Yes
175-575	● Black	5 Watt	550 Lm	2000K~2700K	● Warm white++ ~ warm white +	Yes, dim to warm
175-555	○ White	5 Watt	550 Lm	2000K~2700K	● Warm white++ ~ warm white +	Yes, dim to warm

Spot replaces GU10 light source

Tronix Lighting introduces the perfect substitute for all Ø50mm GU10 Spots: a similar sized all-performance LED spot that has an incredibly stable dimming function and does NOT flicker. This alternative LED spot with internal led driver only counts 26 mm in height (31 mm with cable) for a suitable fit with just any ceiling application. In addition, this competitive light source has a connection block with strain relief, enabling a direct connection onto 230V: a winning solution!

FEATURES:

- Stable and flicker-free
- Only 26 mm in height, cable 15 cm



Spot vervangt GU10 lichtbron

Tronix Lighting lanceert dé vervanger voor Ø50mm GU10 spotjes. Een Ø50 mm ledspot, speciaal ontwikkeld om stabiel te dimmen zonder te flikkeren. De vervangende ledspots zijn slechtst 26 mm hoog (31 mm met kabeldikte) inclusief interne driver en daardoor geschikt voor nagenoeg iedere plafondsituatie. Daarnaast heeft de Tronix ledspot een aansluitblokje met trekontlasting voor directe aansluiting op 230V, waardoor dit spotje een must is voor iedereen!

KENMERKEN:

- Stabiel en flikkervrij
- Slechts 26 mm hoog, kabel 15 cm lang

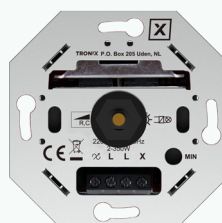

For a perfect dimming result, use the LED spot with the Tronix universal Triac LED dimmer (art. nr. 215-131).

Ø 50 mm Lamps | LED Light Sources

GU10 | 5W | 2700K OR 2000~2700K DTW CRI >97



Input voltage: 220-240V
Power: 5 Watt
LED type: COB
CRI value: >97
Dimmable: Yes (triac)

IP rate: IP20
Length: 58 mm
Diameter: Ø 50 mm
Housing: Aluminium/silver



ART. NR.	POWER	LUMINOUS FLUX	COLOR TEMP. (CCT)	LIGHT COLOR	BEAM ANGLE	DIMMABLE
175-142	5 Watt	350 Lm	2000K~2700k	● Warm white++ ~ warm white +	45°	Yes
175-143	5 Watt	350 Lm	2700K	● Warm white+	35°	Yes

GU10 LED LAMP | 7W | COB



Input voltage: 220-240V
Power: 7 Watt
LED type: COB
Dimmable: Yes (triac)
Beam angle: 35°

IP rate: IP20
Length: 73 mm
Diameter: Ø 50 mm
Housing: Aluminium/silver



ART. NR.	POWER	LUMINOUS FLUX	COLOR TEMP. (CCT)	LIGHT COLOR	DIMMABLE
175-144	7 Watt	600 Lm	2700K	● Warm white+	Yes

MR16 LED LAMP | 5 WATT COB



Input voltage: 12V AC/DC
Power: 5 Watt
LED qty: 1 pc
LED type: COB
Dimmable: No
CRI value: >82

Beam angle: 24°
IP rate: IP20
Length: 51 mm
Diameter: Ø 50 mm
Connection type: MR16
Housing: Aluminium, silver



ART. NR.	POWER	LUMINOUS FLUX	COLOR TEMP. (CCT)	LIGHT COLOR	DIMMABLE
175-138	5 Watt	250 Lm	2700K	● Warm white+	No

MR16 LED LAMP | 5 WATT COB



Input voltage: 12V AC/DC
Power: 5W
LED qty: 1
LED type: COB
Dimmable: No
CRI value: >80

Beam angle: 45°
IP rate: IP20
Length: 50 mm
Diameter: Ø 50 mm
Connection type: MR16
Housing: Aluminium, silver



ART. NR.	POWER	LUMINOUS FLUX	COLOR TEMP. (CCT)	LIGHT COLOR	DIMMABLE
175-154	5 Watt	400 Lm	2700K	● Warm white+	Yes

LED Light Sources | Ø 70 mm Lamps

AR70 LED LAMP | 6/7 WATT | GU10

In 2700K, 3000K or 'dim to warm' 2000K ~ 2700K.



Input voltage: 220-240V
Power: 6/7 Watt
LED type: COB
LED qty: 1
Dimmable: Yes
Beam angle: 24°/36°
CRI value: >92 Ra
IP rate: IP20
Diameter: Ø70 mm
Height: 62 mm
Connection type: GU10
Housing: Aluminium



ART. NR.	POWER	BEAM	CRI	LUMINOUS FLUX	COLOR TEMP. (CCT)	LIGHT COLOR	DIMMABLE
175-344	6 Watt	24°	>92	300 Lm	2000K~2700K	● Warm white++ ~ warm white+	Yes, dim to warm
175-343	6 Watt	24°	>92	300 Lm	2700K	● Warm white+	Yes
175-347	6 Watt	24°	>92	300 Lm	3000K	● Warm white	Yes
175-350	7 Watt	36°	>92	300 Lm	2000K~2700K	● Warm white++ ~ warm white+	Yes, dim to warm

AR70 LED LAMP | 7 WATT DIMMABLE DRIVER | B15D

Including external dimmable driver with EU plug and B15D socket. In 2700K or 'dim to warm' 2000K ~ 2700K.



Input voltage: 220-240V
Power: 7 Watt
LED type: CREE/Shineon
LED qty: 1
Dimmable: Yes
Beam angle: 36°
CRI value: >92/95 Ra
IP rate: IP20
Diameter: Ø70 mm
Height: 49 mm
Connection type: B15D
Housing: Aluminium



ART. NR.	POWER	CRI	LUMINOUS FLUX	COLOR TEMP. (CCT)	LIGHT COLOR	DIMMABLE
175-370	7 Watt	>95	300 Lm	2700K	● Warm white+	Yes
175-372	7 Watt	>92	300 Lm	2000K~2700K	● Warm white++ ~ warm white+	Yes, dim to warm

Ø 111 mm Lamps | LED Light Sources

AR111 LED LAMP | 12 WATT | DIMMABLE



Input voltage: 220-240V
Power: 12 Watt
LED type: COB
LED qty: 1
CRI value rate: >92 Ra
IP rate: IP20
Diameter: Ø111 mm
Height: 60 mm
Connection type: Stripped wire



ART. NR.	POWER	BEAM	CRI	LUMINOUS FLUX	COLOR TEMP. (CCT)	LIGHT COLOR	DIMMABLE
175-316	12 Watt	36°	>92	600 Lm	2000K ~ 2900K	○ Warm white++ ~ warm white	Yes, dim to warm
175-323	12 Watt	24°	>92	650 Lm	2700K	○ Warm white+	Yes
175-324	12 Watt	24°	>92	650 Lm	3000K	○ Warm white	Yes



LED Light Sources | Bulbs

P45 LED LAMP DECO



Input voltage: 220-240V
Power: 1 Watt
LED type: DIP
Dimmable: No
Beam angle: 190°
IP Rate: IP20
Length: 69 mm
Diameter: Ø 45 mm
Connection type: E27
Housing: Clear + PC



ART. NR.	POWER	LUMINOUS FLUX	COLOR TEMP. (CCT)	LIGHT COLOR
165-000	1 Watt	51 Lm	2400K	● Warm white+

P45 LED LAMP | 1 WATT | PC CAP



Input voltage: 220-240V
Power: 1 Watt
LED type: SMD
Dimmable: No
Beam angle: 190°
IP rate: IP20 (IP44 when mounted in Tronix Festoon cable light)
LED type: SMD
Connection type: E27
Housing: PC



ART. NR.	POWER	LUMINOUS FLUX	COLOR TEMP. (CCT)	LIGHT COLOR
165-031	1 Watt	62 Lm	Cold white	○ 6000K
165-038	1 Watt	50 Lm	Warm white+	○ 2700K
165-032	1 Watt	n.a.	Blue	● n.a.
165-033	1 Watt	n.a.	Green	● n.a.
165-034	1 Watt	n.a.	Red	● n.a.
165-035	1 Watt	n.a.	Yellow	● n.a.
165-036	1 Watt	n.a.	Orange	● n.a.

Corn Lamps | LED Light Sources

CORN LED LAMP | 18 WATT

In 3000K or 5000K



Input voltage: 100-240V

Power: 18 Watt

LED type: SMD

Dimmable: No

Beam angle: 360°

IP rate: IP64

Diameter: Ø 64 mm

Length: 187 mm

Connection type: E27



ART. NR.	POWER	LUMINOUS FLUX	COLOR TEMP. (CCT)	LIGHT COLOR
175-536	18 Watt	2340 Lm	3000K	● Warm white
175-537	18 Watt	2340 Lm	5000K	○ Cold white

CORN LED LAMP | 26 WATT

In 3000K or 5000K



Input voltage: 100-240V

Power: 26 Watt

LED type: SMD

Dimmable: No

Beam angle: 360°

IP rate: IP64

Diameter: Ø 64 mm

Length: 207 mm

Connection type: E27



ART. NR.	POWER	LUMINOUS FLUX	COLOR TEMP. (CCT)	LIGHT COLOR
175-538	26 Watt	3380 Lm	3000K	● Warm white
175-539	26 Watt	3380 Lm	5000K	○ Cold white



Corn lamps E27 in 18W/26W
in 3000K or 5000K

Effective outdoor lighting





Cherry Hill 1170 1.8
Welcome Center
State 1403 8X



Tronix Festoon Cable with weather- and shockproof PC LED Lamps Art.nr. 165-000 Nistelrode - The Netherlands
Check Tronix 'Season- & Party catalog' for our complete range of Festoon Cable lights

7

Emergency Lights

Setting best standards for
escape route illumination



Emergency Lights | Exit Signs

EMERGENCY BULK HEAD | 3W | AUTO TEST

With automatically periodic testing of the light source, electronics and battery.



Input voltage: 220-240V
Power: 3 Watt
LED type: SMD2835
IP rate: IP65
Operating time: min. 3 hrs
Pictogram: 8x included
Connection type: Terminal block
Material: PC/clear cover



ART. NR.	MOUNTING	POWER	LUMINOUS FLUX	COLOR TEMP. (CCT)	SIZE (L X W X H)
600-021	Surface	3 Watt	200 Lm	5000K	340 x 61,8 x 105 mm

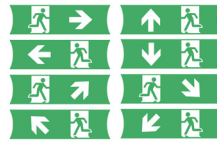

*Pictograms included



LED EXIT SIGN | SURFACE MOUNT | AUTO TEST

Waterproof emergency bulkhead (IP65). With automatically periodic testing of the light source, electronics and battery.



Input voltage: 220-240V
Power: 5 Watt
LED type: SMD2835
Luminous flux: 240 Lm
IP rate: IP65
Operating time: min. 3 hrs
Pictogram: 9x included
Connection type: Terminal block
Material: PC/clear cover



ART. NR.	MOUNTING	POWER	HOUSING COLOR	COLOR TEMP. (CCT)	SIZE (L X W X H)
600-043	Ceiling	5 Watt	○ White	5000K	340 x 194 x 108 mm



*Pictograms included

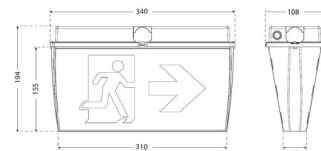

Exit Signs | Emergency Lights

LED EXIT SIGN | SURFACE | WALL & CEILING AUTO TEST



With automatically periodic testing of the light source, electronics and battery.

- Input voltage:** 220-240V
- Power:** 1 Watt
- LED type:** SMD2835
- Luminous flux:** 35 Lm
- IP rate:** IP20
- Operating time:** min. 3 hrs
- Pictogram:** 9x included
- Connection type:** Terminal block
- Material:** Metal/steel housing with acrylic double sided legend panel

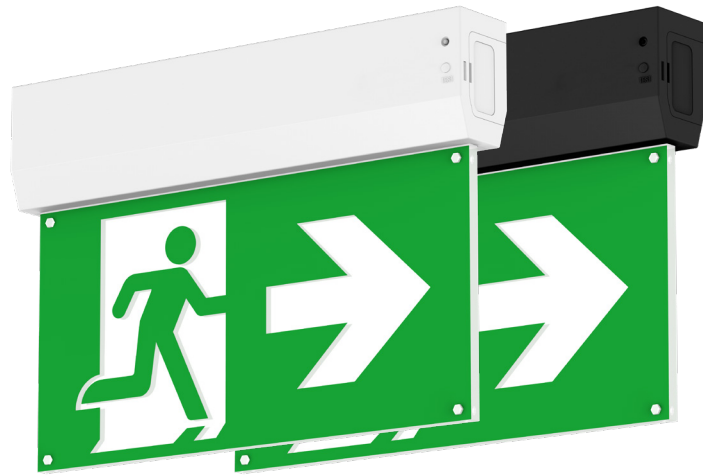

*Wall & ceiling mounting



*Pictograms included



ART. NR.	MOUNTING	HOUSING COLOR	POWER	LUMINOUS FLUX	COLOR TEMP. (CCT)	SIZE (L X W X H)
600-022	Surface	○ White	1 Watt	35 Lm	5000K	315 x 223 x 45 mm
600-018	Surface	● Black	1 Watt	35 Lm	5000K	315 x 223 x 45 mm

ACCESSORIES

ART. NR.	MOUNTING	HOUSING COLOR	SIZE	MOUNTING HOLE	MOUNTING HEIGHT
600-030	Recessed	○ White	385 x 80 x 52 mm	360 x 55 mm	75 mm
600-032	Recessed	● Black	385 x 80 x 52 mm	360 x 55 mm	75 mm
600-031	Pendant	○ White	200 x 25 x 10 mm	n/a	1.5 m (max pendant height)

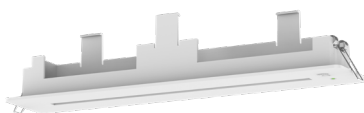

Art. nr. 600-030 Recessed mounting kit | white

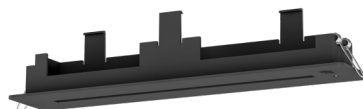

Art. nr. 600-032 Recessed mounting kit | black



Art. nr. 600-031 pendant kit

Emergency Lights | Exit Signs

LED EXIT SIGN | WALL MOUNT | AUTO TEST

Included pictograms up, down, left, up-right, down-right (reversible). With automatically periodic testing of the light source, electronics and battery.



- Input voltage:** 220-240V
- Power:** 1 Watt (exit). 0,5 Watt (light)
- LED type:** SMD3014
- Luminous flux:** 35 Lm
- IP rate:** IP40
- Operating time:** min. 3 hrs
- Pictogram:** 5x included (reversible)
- Connection type:** Terminal block
- Material:** PC/clear cover



ART. NR.	MOUNTING	POWER	HOUSING COLOR	COLOR TEMP. (CCT)	SIZE (L X W X H)
600-019	Surface	5 Watt	● Black	5000K	330 x 190 x 45 mm
600-020	Surface	5 Watt	○ White	5000K	330 x 190 x 45 mm

*Pictograms included (reversible)

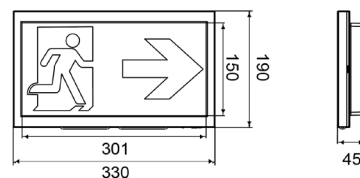
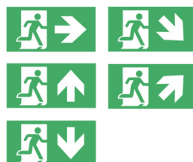

*In maintained mode, only the pictogram is illuminated (38 Lm). When emergency is detected, emergency mode will switch on. The two LED's provides 50 Lm lighting at the bottom of the fixture, useful for extra lighting in the escape route.

Exit Signs | Emergency Lights

LED EXIT SIGN LARGE | SINGLE | AUTO TEST

Extra large exit sign with 70 meter viewing distance, designed for big areas such as warehouses or airports. With automatically periodic testing of the light source, electronics and battery.



- Input voltage:** 220-240V
- Power:** 10/20 Watt
- LED type:** SMD2835
- Luminous flux:** Single 264 Lm, double 528 Lm
- IP rate:** IP20
- Operating time:** min. 3 hrs
- Pictogram:** Single 8x, double 9x included
- Connection type:** Terminal block
- Material:** Aluminium / PMMA

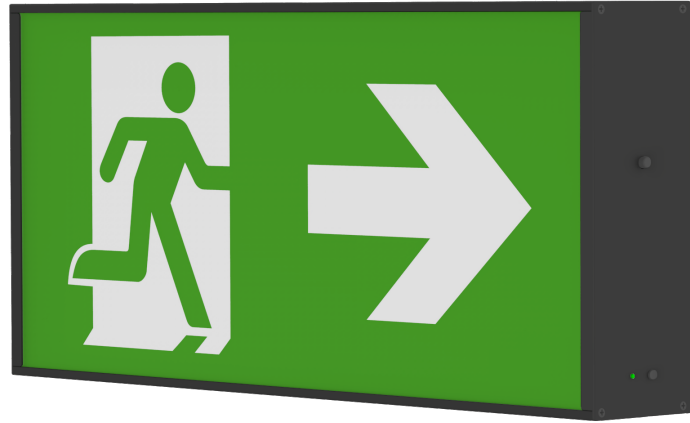

ART. NR.	TYPE	MOUNTING	POWER	COLOR TEMP. (CCT)	SIZE (L X W X H)	PICTOGRAM
600-039	Single	Wall, ceiling, pendant	10 Watt	6000K	744 x 363 x 90 mm	8 x
600-040	Double	Ceiling, pendant	20 Watt	6000K	744 x 363 x 90 mm	9 x (1x empty excluded)

*Pictograms included

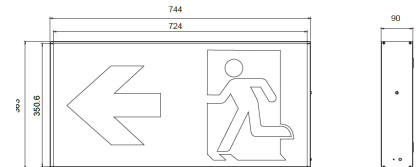

Art. nr. 600-042 mounting plate



Art. nr. 600-041 pendant kit

ART. NR.	ACCESSORIES
600-041	Pendant kit (max 150cm) for 600-039 & 600-040
600-042	Ceiling mounting plate for 600-039 & 600-040

Emergency Lights | Luminaires

EMERGENCY DOWNLIGHT | 3W | Ø140MM BLACK & WHITE | AUTO TEST

Including two optional lenses (round&oval). With automatically periodic testing of the light source, electronics and battery. For surface or recessed mounting. with interchangeable lens. Round for square spaces. Oval for narrow long spaces such as hallways.



Input voltage: 220-240V

Power: 3 Watt

Beam angle: 150° (round), 65° x 160° (oval)

IP rate: IP20

Operating time: min. 3 hrs (internal battery)

Connection type: Screw

Material: PC housing



ART. NR.	HOUSING COLOR	MOUNTING	POWER	LUMINOUS FLUX	COLOR TEMP. (CCT)	DIAMETER	MOUNTING HOLE	(MOUNTING) HEIGHT
600-026	● Black	Surface	3 Watt	240 Lm	5000K	Ø 140 mm	-	61,55 mm
-	● Black	Recessed	3 Watt	240 Lm	5000K	-	Ø 112,5 mm	55,34 mm
600-025	○ White	Surface	3 Watt	240 Lm	5000K	Ø 140 mm	-	61,55 mm
-	○ White	Recessed	3 Watt	240 Lm	5000K	-	Ø 112,5 mm	55,34 mm

EMERGENCY DOWNLIGHT | 3W | Ø55-80MM BLACK & WHITE | AUTO TEST

Including two optional lenses (round&oval). With automatically periodic testing of the light source, electronics and battery. For recessed mounting. with interchangeable lens. Round for square spaces. Oval for narrow long spaces such as hallways. Including extra ring for larger mounting holes.



Input voltage: 220-240V

Power: 3 Watt

Beam angle: 148° (round), 68° x 165° (oval)

IP rate: IP20

Operating time: min. 3 hrs (external battery)

Connection type: Screw

Material: PC housing

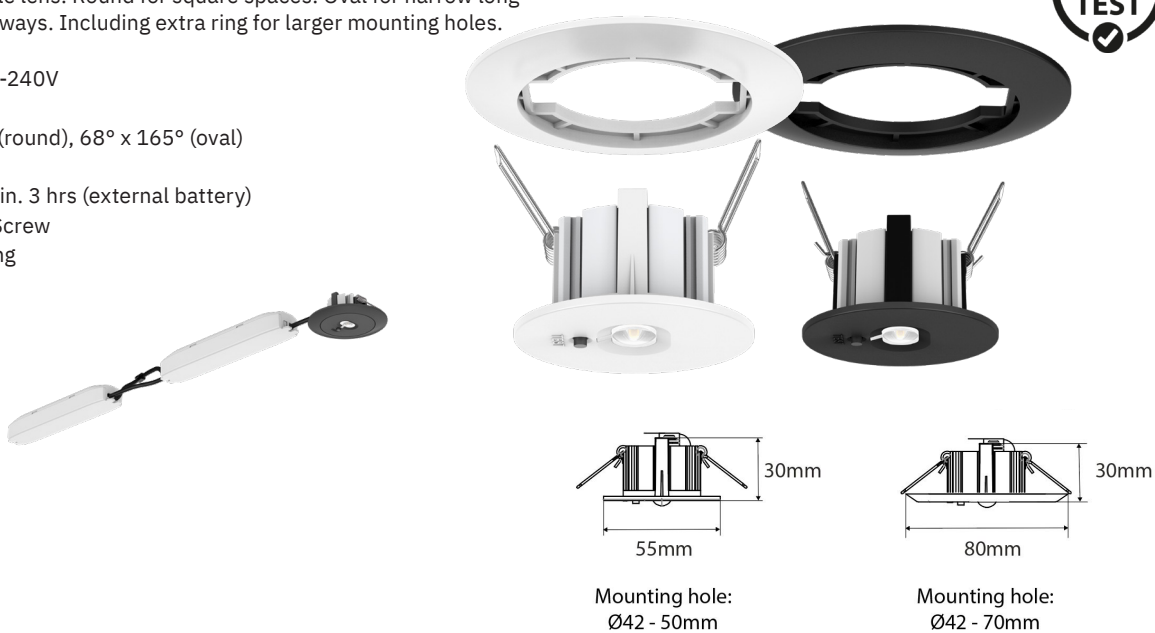

ART. NR.	HOUSING COLOR	MOUNTING	POWER	LUMINOUS FLUX	COLOR TEMP. (CCT)	DIAMETER	MOUNTING HOLE	(MOUNTING) HEIGHT
600-024	● Black	Recessed	3 Watt	240 Lm	5000K	Ø 55 mm	Ø 42-50 mm	30 mm
-	● Black	Recessed	3 Watt	240 Lm	5000K	Ø 80 mm	Ø 42-70 mm	30 mm
600-023	○ White	Recessed	3 Watt	240 Lm	5000K	Ø 55 mm	Ø 42-50 mm	30 mm
-	○ White	Recessed	3 Watt	240 Lm	5000K	Ø 80 mm	Ø 42-70 mm	30 mm

Luminaires | Emergency Lights

EMERGENCY DOWNLIGHT | 3W | 148X148 MM BLACK & WHITE | AUTO TEST



Including two optional lenses (round&oval). With automatically periodic testing of the light source, electronics and battery. For surface or recessed mounting. with interchangeable lens. Round for square spaces. Oval for narrow long spaces such as hallways.

Input voltage: 200-240V

Power: 3 Watt

Beam angle: 150° (round), 65° x 160° (oval)

IP rate: IP20

Operating time: min. 3 hrs (internal battery)

Connection type: Screw

Material: PC housing



ART. NR.	HOUSING COLOR	MOUNTING	POWER	LUMINOUS FLUX	COLOR TEMP. (CCT)	LENGTH	WIDTH	HEIGHT
600-029	● Black	Surface	3 Watt	220 Lm	5000K	148 mm	148 mm	33 mm
600-027	○ White	Surface	3 Watt	220 Lm	5000K	148 mm	148 mm	33 mm

LED EMERGENCY CEILING LIGHT | IP65 BLACK & WHITE | 3-CCT



With CCT switch for pre-settable color temperature 3000K - 4000K - 5700K

Input voltage: 230V

Power: 15 Watt

Dimmable: No

Beam angle: 110°

IP rate: IP65

IK rate: IK08

Operating time: min. 3 hrs (emergency model)

Connection type: Terminal block

Material: PC



ART.NR.	HOUSING COLOR	MOUNTING	POWER	LUMINOUS FLUX	LIGHT COLOR	DIAMETER	HEIGHT	EMERGENCY
136-046	● Black	Surface	15W	1270-1420 Lm	3-CCT	Ø 300 mm	60 mm	Yes
136-045	● Black	Surface	15W	1270-1420 Lm	3-CCT	Ø 300 mm	60 mm	No
136-044	○ White	Surface	15W	1270-1420 Lm	3-CCT	Ø 300 mm	60 mm	Yes
136-043	○ White	Surface	15W	1270-1420 Lm	3-CCT	Ø 300 mm	60 mm	No

Emergency Lights | Luminaires

EMERGENCY LIGHT | 4W | IP65 | BLACK & WHITE AUTO TEST

With automatically periodic testing of the light source, electronics and battery. For surface mounting. The two light heads are independently adjustable.

Input voltage: 230V
Power: 4 Watt
Beam angle: 120°
IP rate: IP65
IK rate: IK02
Operating time: min. 3 hrs (internal battery)
Connection type: Screw terminal
Material: PC housing



ART. NR.	HOUSING COLOR	MOUNTING	POWER	LUMINOUS FLUX	COLOR TEMP. (CCT)	LENGTH	WIDTH	HEIGHT
600-036	● Black	Surface	4 Watt	375 Lm	5000K	279 mm	127 mm	91 mm
600-035	○ White	Surface	4 Watt	375 Lm	5000K	279 mm	127 mm	91 mm

EMERGENCY LIGHT | 8W | BLACK & WHITE AUTO TEST

With automatically periodic testing of the light source, electronics and battery. For surface mounting. The two light heads are independently adjustable.

Input voltage: 220-240V
Power: 8 Watt
Beam angle: 120°
IP rate: IP20
IK rate: IK07
Operating time: min. 3 hrs (internal battery)
Connection type: Screw terminal
Material: PC housing



ART. NR.	HOUSING COLOR	MOUNTING	POWER	LUMINOUS FLUX	COLOR TEMP. (CCT)	LENGTH	WIDTH	HEIGHT
600-038	● Black	Surface	8 Watt	1200 Lm	5000K	235 mm	130 mm	65 mm
600-037	○ White	Surface	8 Watt	1200 Lm	5000K	235 mm	130 mm	65 mm

Luminaires | Emergency Lights

LED EMERGENCY TRACK LIGHT | 1.7 | 70mA AUTO TEST

Can be directly connected on a 3-phase track rail. With automatically periodic testing of the light source, electronics and battery.

Input voltage: 220-240V

Power: 1.7 Watt

Beam angle: 26°

IP rate: IP20

Operating time: min. 3 hrs (internal battery)

Connection type: 3-phase track rail

Material: PC

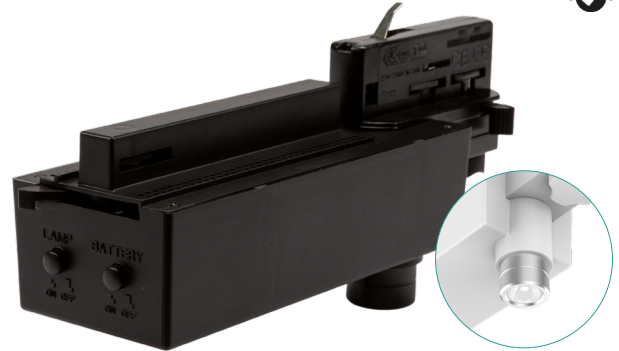

ART. NR.	HOUSING COLOR	MOUNTING	POWER	LUMINOUS FLUX	COLOR TEMP. (CCT)	LENGTH	WIDTH	HEIGHT
600-033	● Black	Surface	1.7 Watt	220 Lm	5000K	212 mm	63 mm	98 mm
600-034	○ White	Surface	1.7 Watt	220 Lm	5000K	212 mm	63 mm	98 mm

Auto test - Automatic testing - IEC 62034



Autotest is a function that provides emergency lighting for automatic periodic testing of the light source, electronics and battery. This is a protocol that complies with the international standard IEC 62034.

1. Test after commissioning: Takes place as soon as the luminaire is connected for the first time. The batteries are charging for 24 hours; after 24 hours a full autonomy test takes place. After that, the batteries are recharging again for 24 hours.
2. Short function test: for 3 seconds the luminaire tests (after pressing and releasing the test button) the condition of battery, electronics and light source.
3. Monthly function test: automatic 3-minute monthly test.
4. Annual autonomy test: 3-hour automatic, annual, full autonomy test.

Auto test - Automatisch testen - IEC 62034

Autotest is de nieuwst ontwikkelde functie voor Tronix noodverlichting. Het voorziet noodverlichting automatisch periodieke testen van de lichtbron, elektronica en batterij, volgens een protocol dat voldoet aan de internationale norm IEC 62034.

1. Test na ingebruikname: vindt plaats zodra het armatuur voor het eerst met netspanning is verbonden. De batterij wordt 24 uur lang geladen, waarna een volledige autonomietest plaatsvindt. Daarna wordt de batterij opnieuw 24 uur geladen.
2. Korte functie test: gedurende 3 seconden test het armatuur (na het indrukken en loslaten van de testknop) de conditie van batterij, elektronica en lichtbron.
3. Maandelijks functie test: automatische maandelijks test van 3 minuten.
4. Jaarlijkse autonome test: automatische, jaarlijkse, volledige autonome test van 3 uur.



Emergency Light at office building, Art.nr. 600-022 with 'recessed mounting kit black' Art.nr. 600-032, Poort van Uden - The Netherlands

Packs & Accessories | Emergency Lights

LED EMERGENCY PACK | 10-60V | 70mA | AUTO TEST

To convert LED panels, downlights or other ceiling lights into luminaires with an emergency function.



Input voltage: 220-240V
Output current: Adjustable - 50/60/70 mA
Output voltage: 10-60V
Battery: Lipo 6,4V 3200mA

ART. NR.	SIZE	OPERATING TIME
600-028	145 x 36,8 x 23,5 mm	Min. 3 hrs



REPLACEMENT BATTERIES

Replacement battery for Tronix emergency lights.



Type: Li-ion or LiPo
IP rate: IP20
Operating time: min. 3 hrs



ART. NR.	SUITABLE FOR	INCL. CASE	TYPE	VOLTAGE	CURRENT
600-100	600-022	No	LiPo	6.4V	600 mA
600-101	600-021, 600-023, 600-024	No	LiPo	6.4V	1500 mA
600-102	600-035, 600-036	No	Li-ion	3.7V	440 mA
600-103	600-028	Yes	LiPo	6.4V	3200 mA
600-104	600-025, 600-026, 600-033	No	LiPo	6.4V	1500 mA



8

High Bays

High savings with High Bay lighting
solutions for every warehouse





High Bays | Ufo

UFO HIGH BAY | 190 Lm/W | 100/150W

High lumen (190 Lm/W) High Bay with a 90° beam angle and a 120° optional lens available. This High Bay is provided with a jack plug connector for connecting a sensor (see below page for accessories).

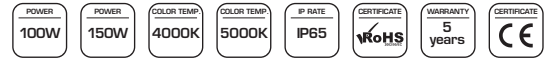

Input voltage: 100-240V
Power: 100/150 Watt
Led type: SMD2835
Beam angle: 90° (optional 120°)
CRI value: >70
IP rate: IP65
Cable length: 100 cm
Connection type: Schuko plug

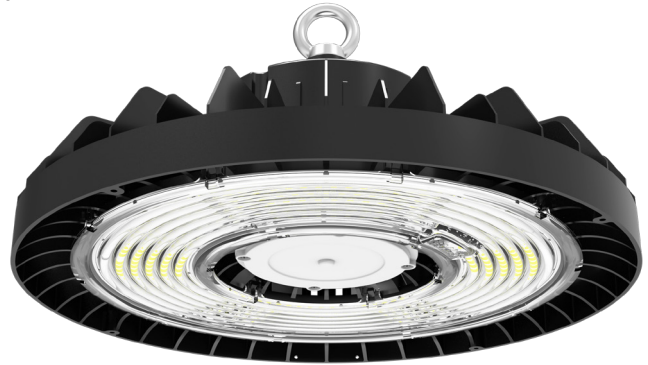

ART. NR.	POWER	LUMINOUS FLUX	COLOR TEMP.	DIAMETER	HEIGHT (INCL. HOOK)
950-105	100 Watt	19.000 Lm	4000K	Ø 360 mm	186 mm
950-106	100 Watt	19.000 Lm	5000K	Ø 360 mm	186 mm
950-110	150 Watt	28.500 Lm	4000K	Ø 360 mm	186 mm
950-111	150 Watt	28.500 Lm	5000K	Ø 360 mm	186 mm

ART. NR. ACCESSORIES

950-112	Lens for UFO high bay high luminous flux 190 Lm/W 120°
950-113	Reflector for UFO high bay high luminous flux 190 Lm/W black
950-114	Reflector for UFO high bay high luminous flux 190 Lm/W acrylate
950-115	Sensor motion for UFO high bay 190 Lm/W (PIR)
950-116	Remote for sensor motion 950-115 for UFO high bay 190 Lm/W



Art. nr. 950-112



Art. nr. 950-113



Art. nr. 950-114



Art. nr. 950-115



Art. nr. 950-116



Tronix Ufo Highbay and Black Reflector (Art.nr. 950-113) Intrax Oss - The Netherlands



Tronix High Bay (Art.nr. 950-024) at Intratuin store Veghel - The Netherlands

50W | High Bays

HIGH BAY | 50W | 130 LM/W | 3-CCT | NON DIMMABLE

White High Bay with aluminum housing and polycarbonate cover. With CCT switch for pre-settable color temperature 3000K - 4000K - 5000K.



- Input voltage:** 100-240V
- Power:** 50 Watt
- Led type:** SMD2835
- Beam angle:** 120°
- CRI value:** >80
- IP rate:** IP65
- Cable length:** 100 cm
- Connection type:** Schuko plug



ART. NR.	POWER	LUMINOUS FLUX	BEAM ANGLE	LIGHT COLOR	DIAMETER
950-024	50W	6500 Lm	120°	3-CCT	Ø 278 mm

UFO HIGH BAY | 80W~150W | 140 LM/W 5000K POWER/BEAM ADJUSTABLE

Pre-settable power (DIP-switch) 80/100/120/150 Watt and pre-settable beam angle 60°/80°/100° (lens rotatable). This High Bay is provided with a jack plug connector for connecting a sensor (see below page for accessories).



- Input voltage:** 220-240V
- Power:** 80/100/120/150 Watt
- Led type:** SMD3030
- Beam angle:** 60° / 80° / 100°
- CRI value:** >70
- IP rate:** IP42
- Cable length:** 150 cm
- Connection type:** Schuko plug



ART. NR.	POWER	LUMINOUS FLUX	BEAM ANGLE	COLOR TEMP.	DIAMETER
950-120	80/100/120/150W	21.000 Lm (max.)	60°/80°/100°	5000K	Ø 320 mm

ART. NR. ACCESSORIES

- 950-121 Sensor motion for UFO high bay 950-120 (microwave)
- 950-122 Remote for sensor motion 950-121 for UFO high bay 950-120



Art. nr. 950-121



Art. nr. 950-122

9

Industrial Fixtures & Line Lighting

Meeting high expectations in
industrial lighting solutions





Industrial Fixtures & Line Lighting

TRI-PROOF LIGHTBAR | IP65 | 3-CCT

Pre-settable lightcolor 3000K - 4000K - 5700K and pre-settable powerswitch. For easily installation, the mounted brackets can be moved 20 cm. For modular design, the LEDpart and driver can be easily replaced. 4x2,5mm2 wiring.



Input voltage: 200-240V

Power: 12~20/25~40/35~60 Watt

Power Factor: >0,90

Beam angle: 120°

IP Rate: IP65

IK Rate: IK08

Connection Type: Screw terminal (2x M20)

Cover: PC Opal

Accessories included: Mounting clip (2pcs) and cable gland (2pcs)



How many fixtures
can be connected in
one line?

Max. 1500 Watt

ART. NR.	MAX. POWER	MAX. LUMINOUS FLUX	LIGHT COLOR	LENGTH	WIDTH	HEIGHT
950-086	20 Watt	2420 Lm	3-CCT	650 mm	89 mm	70 mm
950-087	40 Watt	5380 Lm	3-CCT	1260 mm	89 mm	70 mm
950-088	60 Watt	8100 Lm	3-CCT	1560 mm	89 mm	70 mm



Industrial Fixtures & Line Lighting

TRI-PROOF LIGHTBAR | 1500MM | 45W IP66 | 5000K

Ammonia resistant lightbar, ideal for car washes or agro industry. The fixtures can be connected upto 35 pieces and can be mounted with the two included clips.

Input voltage: 220-240V
Power: 45 Watt
Dimmable: Yes
Beam angle: 140°
Color temperature: 5000K
IP rate: IP66
IK rate: IK06
Connection type: Terminal block
Material: Aluminium & PC

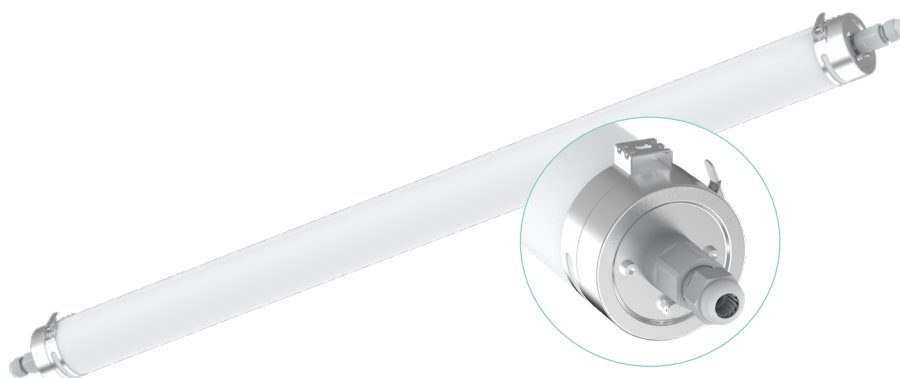

ART. NR.	POWER	LUMINOUS FLUX	LIGHT COLOR	LENGTH	DIAMETER
950-095	45 Watt	5300 Lm	5000K	1500 mm	Ø75,2 mm

LIGHTBAR 150 CM | 52W | IP65 | 3-CCT

Pre-settable to 3000K, 4000K and 5700K through the switch on the fixture. Quick to assemble by using the simple click system. Both for opening the fixture, and the built-in connection block.

Input voltage: 220-240V
Power: 52 Watt
Dimmable: No
Beam angle: 120°
Color temperature: 3000K/4000K/5700K
IP rate: IP65
IK rate: IK08
Connection type: Screw terminal (2x M20)
Material: Aluminium & PC
Accessories included: Mounting clip (2pcs)



ART. NR.	POWER	MAX. LUMINOUS FLUX	LIGHT COLOR	LENGTH	WIDTH	HEIGHT
950-078	52 Watt	8000 Lm	3-CCT	1500 mm	77 mm	69 mm

ACCESSORIES

ART. NR.	ACCESSORIES
950-079	Suspension set 5 meter



Industrial Fixtures & Line Lighting

BATTEN LIGHT | 20/40/10~25W | IP20 | 3-CCT

With CCT switch for pre-settable color temperature 3000K - 4000K - 5700K. Equipped with internal terminal block for wiring in and out. 10~25W: With DIP switch for pre-settable power.



- Input voltage:** 220-240V
- Power:** 20/40/10~25 Watt
- Dimmable:** No
- Beam angle:** 120°
- Color temperature:** 3000K/4000K/5700K
- IP rate:** IP20
- IK rate:** IK08
- Connection type:** Terminal block
- Material:** Aluminium & PC



ART. NR.	POWER	LUMINOUS FLUX	LIGHT COLOR	LENGTH	WIDTH	HEIGHT
136-300	20 Watt	1800 - 2200 Lm	3-CCT	603 mm	71 mm	64 mm
136-301	40 Watt	4000 - 4600 Lm	3-CCT	1203 mm	71 mm	64 mm
136-305	10~25 Watt	1050 - 2500 Lm	3-CCT	600 mm	124 mm	68 mm

BATTEN LIGHT FLAT | 2 SIZES | 18/30W | IP20 3-CCT

With CCT switch for pre-settable color temperature 3000K - 4000K - 5700K.



- Input voltage:** 200-240V
- Power:** 18/30 Watt
- Dimmable:** No
- Beam angle:** 120°
- Color temperature:** 3000K/4000K/5700K
- IP rate:** IP20
- IK rate:** IK06
- Connection type:** Stripped wire
- Power cable:** 60 cm (on the back of the fixture)
- Housing material:** PC

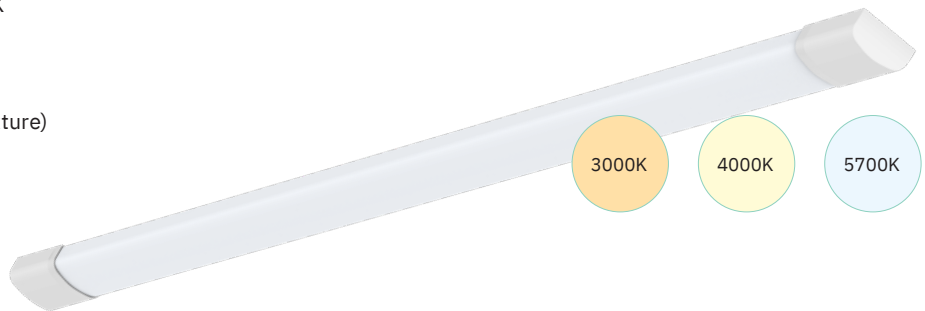

ART. NR.	POWER	LUMINOUS FLUX	LIGHT COLOR	LENGTH	WIDTH	HEIGHT
136-310	18 Watt	1450 - 1750 Lm	3-CCT	690 mm	56,5 mm	27,5 mm
136-311	30 Watt	3100 - 3400 Lm	3-CCT	1200 mm	56,5 mm	27,5 mm

10 Floodlights

Powerful illumination of outdoor
areas, building facades or objects





HOUSE
OF
BEERS

PRO | Floodlights

FLOODLIGHT PRO | 50/100/200/300W

With surge protection against peak voltages and external air pressure valve for air pressure regulation inside and outside (no moisture inside fixture).

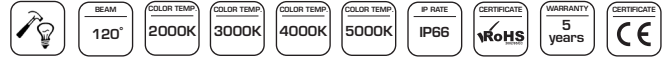

- Input voltage:** 220-240 Volt
- Power:** 50/100/200/300 Watt
- LED type:** SMD3030
- Dimmable:** No
- Beam angle:** 120°
- CRI value:** >70
- IP rate:** IP66
- IK rate:** IK08
- Connection type:** Schuko plug
- Wire length:** 150 cm
- Housing:** Aluminium
- Finish:** Black (powder coated)



ART. NR.	POWER	LUMINOUS FLUX	COLOR TEMP. (CCT)	WIDTH	HEIGHT	HEIGHT INCL. HANDLE	DEPTH
146-322	50 Watt	6.250 Lm	● 2000K	190 mm	200 mm	267 mm	55 mm
146-320	50 Watt	6.250 Lm	● 3000K	190 mm	200 mm	267 mm	55 mm
146-321	50 Watt	6.250 Lm	○ 4000K	190 mm	200 mm	267 mm	55 mm
146-334	100 Watt	12.500 Lm	● 2000K	230 mm	240 mm	314 mm	61 mm
146-330	100 Watt	12.500 Lm	● 3000K	230 mm	240 mm	314 mm	61 mm
146-331	100 Watt	12.500 Lm	○ 4000K	230 mm	240 mm	314 mm	61 mm
146-344	200 Watt	25.000 Lm	● 2000K	300 mm	305 mm	398 mm	70 mm
146-340	200 Watt	25.000 Lm	● 3000K	300 mm	305 mm	398 mm	70 mm
146-341	200 Watt	25.000 Lm	○ 4000K	300 mm	305 mm	398 mm	70 mm
146-350	300 Watt	37.500 Lm	● 3000K	363 mm	370 mm	470 mm	80 mm
146-352	300 Watt	37.500 Lm	○ 5000K	363 mm	370 mm	470 mm	80 mm

ART.NR. ACCESSORIES

146-327	Floodlight PRO lens for 50W 60°
146-325	Floodlight PRO lens for 50W asymmetrical
146-329	Floodlight PRO wall bracket 50W 1 meter
146-337	Floodlight PRO lens for 100W 60°
146-335	Floodlight PRO lens for 100W asymmetrical
146-346	Floodlight PRO lens for 200W 30°
146-347	Floodlight PRO lens for 200W 60°
146-345	Floodlight PRO lens for 200W asymmetrical
146-356	Floodlight PRO lens for 300W 30°
146-357	Floodlight PRO lens for 300W 60°
146-355	Floodlight PRO lens for 300W asymmetrical
146-360	Floodlight PRO 60MM pole mounting adapter
146-361	Floodlight PRO pole clamp bracket



Art.nr. 146-360

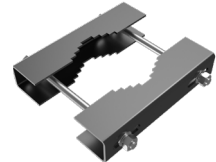

Art.nr. 146-361



Art.nr. 146-329

11

Area Lighting

For bright and powerful illumination
of parking, retail or commercial
areas or other general spaces



Area Lighting | Parking Lights

POST TOP LIGHT | 3-CCT

With CCT switch for pre-settable color temperature 2700K - 3300K - 4000K and pre-settable power-switch 12 - 20 - 30 - 40W. Due to the flicker-free light, these lamps are extremely well suited for placement in gardens, stores or business premises.

- Input voltage:** 230V
- Power:** 12~40 Watt
- Beam angle:** 120°
- IP rate:** IP66
- IK rate:** IK09
- Connection diameter:** 60 mm
- Connection type:** Terminal block
- Housing:** Aluminium
- Finish:** Black or silver



ART. NR.	HOUSING	MAX. POWER	LUMINOUS FLUX	LIGHT COLOR	DIAMETER	HEIGHT
220-041	● Black	40 Watt	3960 Lm (max)	3-CCT	Ø 371 mm	420 mm
220-042	● Silver	40 Watt	3960 Lm (max)	3-CCT	Ø 371 mm	420 mm



Art. nr. 220-045



Art. nr. 220-046



ART. NR.	HOUSING	ACCESSORIES
220-045	● Black	Post top light wall bracket black
220-046	● Silver	Post top light wall bracket silver



Post top light 3-CCT Art.nr. 220-042, Tronix Lighting Uden - The Netherlands

Area Lighting | Parking Lights

PARKING LIGHT FIXTURE | E27 SOCKET

Excluding lamp



Input voltage: E27 light bulb (not included)

IP Rate: IP54

IK Rate: IK09

Connection diameter: Ø 60 mm

Material: PET + Aluminium



ART. NR.	DIAMETER Ø	HEIGHT
220-040	590 mm	459 mm

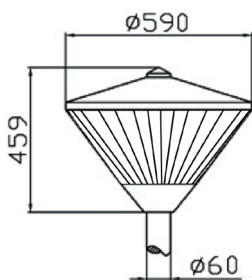

CORN LAMP | E27

ART. NR.	POWER	LUMINOUS FLUX	COLOR TEMP. (CCT)
175-536	18 Watt	2340 Lm	○ 3000K
175-537	18 Watt	2340 Lm	○ 5000K
175-538	26 Watt	3380 Lm	○ 3000K
175-539	26 Watt	3380 Lm	○ 5000K



Parking Lights | Area Lighting

STREET LIGHT | 4000K | CREE LED PHILIPS DRIVER



With built-in surge protection, avoiding any possible damage caused by lightning or sudden electric pulses.

- Input voltage:** 220-240V
- Power:** 38/73/110/150 Watt
- LED type:** Cree LED XP-G3
- Driver:** Philips
- Beam angle:** 90°
- IP rate:** IP65
- IK rate:** IK08
- Connection diameter:** 60 mm
- Connection type:** Terminal block
- Housing:** Aluminium
- Finish:** RAL7024



Art. nr. 220-050 - 220-051



Art. nr. 220-052 - 220-055



ADJUSTABLE ANGLE



USER FRIENDLY
MAINTENANCE



EASY REMOVAL OF COMPONENTS

ART. NR.	POWER	LUMINOUS FLUX	COLOR TEMP. (CCT)	LED QTY	LENGTH	WIDTH	HEIGHT
220-050	38 Watt	4535 Lm	○ 4000K	16	472 mm	240 mm	100 mm
220-051	73 Watt	8924 Lm	○ 4000K	32	568 mm	240 mm	115 mm
220-052	110 Watt	13178 Lm	○ 4000K	48	762 mm	370 mm	130 mm
220-055	150 Watt	18391 Lm	○ 4000K	72	762 mm	370 mm	130 mm



Art. nr. 220-062



Art. nr. 220-080



Art. nr. 220-081

ART. NR. ACCESSORIES

- 220-062 LED street light | mounting/wall support 60mm | RAL7024
- 220-080 Street light acc. | light dark switch at NEMA 3 Socket
- 220-081 Drill bit | 38 mm | for 220-080 sensor



12

Garden Lights & Ground Spots

For attractive illumination of
gardens, patio's or driveways



Garden Lights & Spots | Ground Spots 220-240V

GROUND SPOT | 230V | 106MM | 9W

The beam angle of 36° is 22° projectable. Due to the PU cable, IK10 and anti-condensation valve, this spot is ideal for 'heavy' applications.

Input voltage: 230V

Power: 9 Watt

LED qty: 1 pc

LED type: CREE 1304

IP rate: IP67

IK rate: IK10

Connection type: Stripped wire

Wire length: 3 meter (PU, H07BQ-F)

Material: Stainless steel, aluminium

Dimmable: Yes



ART. NR.	POWER	LUMINOUS FLUX	COLOR TEMP. (CCT)	LIGHT COLOR	BEAM	DIAMETER Ø	MOUNTING Ø	MOUNTING DEPTH
140-082	9 watt	687 Lm	2700K	● Warm white+	36°	106 mm	98 mm	151 mm
140-081	9 watt	687 Lm	3000K	○ Warm white	36°	106 mm	98 mm	151 mm

GROUND SPOT | 230V | 123MM | 16W

The beam angle of 38° is 22° projectable. Due to the PU cable, IK10 and anti-condensation valve, this spot is ideal for 'heavy' applications.

Input voltage: 230V

Power: 16 Watt

LED qty: 1 pc

LED type: CREE 1507

IP rate: IP67

IK rate: IK10

Connection type: Stripped wire

Wire length: 3 meter (PU, H07BQ-F)

Material: Stainless steel, aluminium

Dimmable: Yes



ART. NR.	POWER	LUMINOUS FLUX	COLOR TEMP. (CCT)	LIGHT COLOR	BEAM	DIAMETER Ø	MOUNTING Ø	MOUNTING DEPTH
140-086	16 Watt	1084 Lm	2700K	● Warm white+	38°	123 mm	111 mm	177 mm
140-085	16 Watt	1084 Lm	3000K	○ Warm white	38°	123 mm	111 mm	177 mm

GROUND SPOT | 230V | 123MM | 23W

The beam angle of 38° is 22° projectable. Due to the PU cable, IK10 and anti-condensation valve, this spot is ideal for 'heavy' applications.

Input voltage: 230V

Power: 23 Watt

LED qty: 1 pc

LED type: CREE CXA1816

IP rate: IP67

IK rate: IK10

Connection type: Stripped wire

Wire length: 3 meter (PU, H07BQ-F)

Material: Stainless steel, aluminium

Dimmable: Yes



ART. NR.	POWER	LUMINOUS FLUX	COLOR TEMP. (CCT)	LIGHT COLOR	BEAM	DIAMETER Ø	MOUNTING Ø	MOUNTING DEPTH
140-090	23 Watt	2200 Lm	2700K	● Warm white+	38°	123 mm	111 mm	177 mm
140-089	23 Watt	2200 Lm	3000K	○ Warm white	38°	123 mm	111 mm	177 mm

GROUND SPOT | 230V | 170MM | 28W

The beam angle of 40° is 22° projectable. Due to the PU cable, IK10 and anti-condensation valve, this spot is ideal for 'heavy' applications.

Input voltage: 230V

Power: 28 Watt

LED qty: 1 pc

LED type: CREE CXA2520

IP rate: IP67

IK rate: IK10

Connection type: Stripped wire

Wire length: 3 meter (PU, H07BQ-F)

Material: Stainless steel, aluminium

Dimmable: Yes

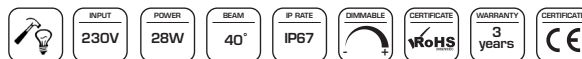

ART. NR.	POWER	LUMINOUS FLUX	COLOR TEMP. (CCT)	LIGHT COLOR	BEAM	DIAMETER Ø	MOUNTING Ø	MOUNTING DEPTH
140-094	28 Watt	3298 Lm	2700K	● Warm white+	40°	170 mm	150 mm	233 mm
140-093	28 Watt	3298 Lm	3000K	○ Warm white	40°	170 mm	150 mm	233 mm

Ground Spots 24V | Garden Lights & Spots

GROUND SPOT | 24V | 42MM

IK08 groundspot with stainless steel cover. Driver exluded, see drivers & controllers for 24V drivers.



Input voltage: 24V
Power: 2,4 Watt
LED qty: 1 pc
LED type: CREE XP
IP rate: IP67

IK rate: IK08
Connection type: Stripped wire
Wire length: 3 meter
Material: Stain steel 316, alu
Dimmable: No



ART. NR.	POWER	LUMINOUS FLUX	COLOR TEMP. (CCT)	LIGHT COLOR	BEAM	COLOR RING	DIAMETER Ø	MOUNTING Ø	MOUNTING DEPTH
140-014	2,4 Watt	111 Lm	3000K	○ Warm white	120°	Grey	42 mm	39 mm	90 mm

GROUND SPOT | 24V | 55MM

IK08 groundspot with aluminium cover. Driver exluded, see drivers & controllers for 24V drivers.



Input voltage: 24V
Power: 2,5 Watt
LED qty: 1 pc
LED type: CREE XP
IP rate: IP67

IK rate: IK08
Connection type: Stripped wire
Wire length: 3 meter
Material: Aluminium
Dimmable: No



ART. NR.	POWER	LUMINOUS FLUX	COLOR TEMP. (CCT)	LIGHT COLOR	BEAM	COLOR RING	DIAMETER Ø	MOUNTING Ø	MOUNTING DEPTH
140-012	2,5 Watt	111 Lm	3000K	○ Warm white	40°	Bronze	55 mm	42 mm	45 mm
140-013	2,5 Watt	111 Lm	3000K	○ Warm white	40°	Grey	55 mm	42 mm	45 mm

GROUND SPOT | 24V | 60MM

IK08 groundspot with aluminium cover. Driver exluded, see drivers & controllers for 24V drivers.



Input voltage: 24V
Power: 2,4 Watt
LED qty: 1 pc
LED type: CREE XP
IP rate: IP67

IK rate: IK08
Connection type: Stripped wire
Wire length: 3 meter
Material: Aluminium
Dimmable: No



ART. NR.	POWER	LUMINOUS FLUX	COLOR TEMP. (CCT)	LIGHT COLOR	BEAM	COLOR RING	DIAMETER Ø	MOUNTING Ø	MOUNTING DEPTH
140-015	2,4 Watt	111 Lm	3000K	○ Warm white	120°	Grey	60 mm	41 mm	87 mm
140-016	2,4 Watt	111 Lm	3000K	○ Warm white	2 x 120°	Grey	60 mm	41 mm	87 mm

GROUND SPOT | 24V | 106MM

IK10 groundspot with stainless steel ring. Driver exluded, see drivers & controllers for 24V drivers.



Input voltage: 24V
Power: 8,5 Watt
LED qty: 1 pc
LED type: CREE 1304
IP rate: IP67

IK rate: IK10
Connection type: Stripped wire
Wire length: 3 meter
Material: Stainless steel + alu body
Dimmable: No



ART. NR.	POWER	LUMINOUS FLUX	COLOR TEMP. (CCT)	LIGHT COLOR	BEAM	COLOR RING	DIAMETER Ø	MOUNTING Ø	MOUNTING DEPTH
140-017	8,5 Watt	533 Lm	3000K	○ Warm white	36°	Grey	106 mm	98 mm	151 mm

Garden Lights & Spots | Ground Spots

GROUND SPOT | EMPTY HOUSING | Ø120MM

Empty housing with GU10 socket and long PU-H07BQF cable for intensive and heavy use. GU10 spot excluded (max. 5W Spot due to installation height).



IP rate: IP67

IK rate: IK10

Connection type: Stripped wire

Wire length: 3 meters

Material: Stainless steel, aluminium, glass



ART. NR.	DIAMETER Ø	MOUNTING Ø	MOUNTING DEPTH	FITTING
140-040	152 mm	93 mm	88 mm	GU10

SUITABLE LAMPS:



ACCESSORIES | CONNECTION TUBE 2 WAY / 3 WAY

For watertight connections



IP rate: IP65 / IP66

Material: PC / RVS screws

ART. NR.	NR. OF OUTPUTS	IP RATE
142-007	1	IP65
142-011	2	IP65
142-020	7	IP66
142-021	7	IP66



142-007



142-011



142-020



142-021

Ground Spots | Garden Lights & Spots

GROUND SPOT | 100-240V | 145/195MM 10,3/18,8W

With asymmetrical beam angle 25° x 53° and stainless steel cover.



Input voltage: 100-240V

Power: 10,3/18,8 Watt

LED type: CREE XP2

IP rate: IP67

IK rate: IK09

Connection type: Stripped wire

Wire length: 3 meter (PU cable H07BQF)

Material: Stainless steel, aluminium

Dimmable: No



ART. NR.	POWER	LUMINOUS FLUX	COLOR TEMP. (CCT)	LIGHT COLOR	BEAM	DIAMETER Ø	MOUNTING Ø	MOUNTING DEPTH
140-074	10,3 Watt	700 Lm	3000K	○ Warm white	25° x 53°	145 mm	130 mm	91 mm
140-075	18,8 Watt	1300 Lm	3000K	○ Warm white	25° x 43°	195 mm	174 mm	111 mm

Groundspots and water drainage

Ground spots have a lot to endure outside, so it is important to follow the guidelines below for maximum protection against water and dust.

- Install ground spots in a well draining subsoil
- Always install a ground spot on a flat or higher surface.
- Place the ground spot (with equipped pot) in a hole that leaves room for a 30-40 cm thick layer of gravel. This ensures faster draining after heavy rain fall and avoids the rising of groundwater.

Grondspots en waterafvoer

Grondspots hebben het buiten zwaar te verduren dus voor maximale bescherming tegen water en stof is het belangrijk om de volgende richtlijnen te volgen:

- Installeer grondspots altijd op een goed water doorlatende ondergrondlaag.
- Plaats grondspots altijd op een vlak of hoger oppervlak, nooit in een kuil.
- Plaats grondspots (incl. bijgeleverde kunststof koker) in een gat dat onderin ruimte overlaat voor een grindlaag van 30-40 cm dik. Dit zorgt voor een snellere waterafvoer na zware regenval en voorkomt de stijging van grondwater.

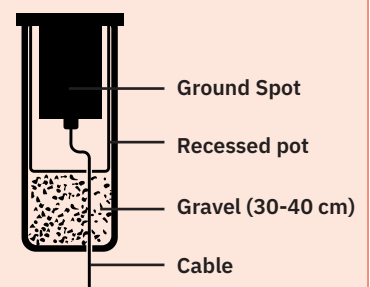

Garden Lights & Spots | Garden Spots

GARDEN SPOT | 40° | 2300K/2700K/3000K | 8W

Ideal for illuminating trees, facades, bushes or other outdoor objects.



Input voltage: 220-240V
Power: 8 Watt
LED qty: 3 pc
LED type: CREE XP-E2
IP rate: IP65
Connection type: Schuko plug
Wire length: 2 meter
Material: Aluminium
Dimmable: Yes



ART. NR.	POWER	LUMINOUS FLUX	BEAM	COLOR TEMP. (CCT)	LIGHT COLOR	SIZE LxWxH
149-356	8 Watt	521 Lm	40°	2300K	● Warm white++	104 x 67 x 92 mm
149-355	8 Watt	521 Lm	40°	2700K	● Warm white+	104 x 67 x 92 mm
149-350	8 Watt	521 Lm	40°	3000K	● Warm white	104 x 67 x 92 mm

GARDEN SPOT | 40° | 2700K/3000K | 10W

Ideal for illuminating trees, facades, bushes or other outdoor objects.



Input voltage: 220-240V
Power: 10 Watt
LED qty: 1 pc
LED type: CREE COB1507
IP rate: IP65
Connection type: Schuko plug
Wire length: 2 meter
Material: Aluminium
Dimmable: Yes

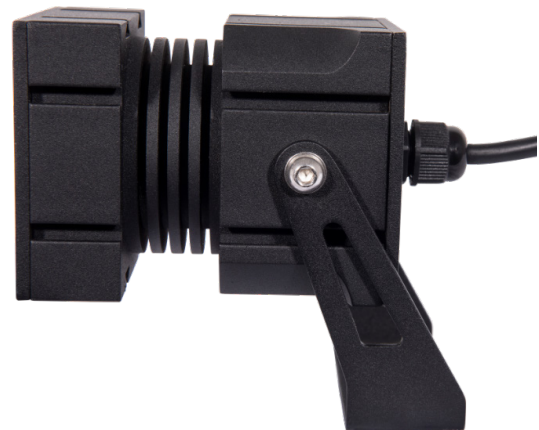

ART. NR.	POWER	LUMINOUS FLUX	BEAM	COLOR TEMP. (CCT)	LIGHT COLOR	SIZE LxWxH
149-358	10 Watt	909 Lm	40°	2700K	● Warm white+	123 x 79 x 117 mm
149-351	10 Watt	909 Lm	40°	3000K	● Warm white	123 x 79 x 117 mm

ACCESSORIES

ART. NR.	ACCESSORIES
149-352	Spike for garden spot 120 mm 149-350 & 149-351



Garden Spots | Garden Lights & Spots

GARDEN SPOT | 24V | 40° | 2,5W 2300K/2700K/3000K



Low voltage garden spot, ideal for safely illuminate trees, facades, bushes or other outdoor objects in public spaces.

- Input voltage:** 24V
- Power:** 2,5 Watt
- LED qty:** 1 pc
- LED type:** CREE XP-E2
- IP rate:** IP65
- Connection type:** Stripped wire
- Wire length:** 3 meter
- Material:** Aluminium
- Dimmable:** No



ART. NR.	POWER	LUMINOUS FLUX	BEAM	COLOR TEMP. (CCT)	LIGHT COLOR	SIZE (L X W X H)
149-403	2,5 Watt	179 Lm	40°	2300K	● Warm white++	68 x 58 x 68 mm
149-402	2,5 Watt	179 Lm	40°	2700K	● Warm white+	68 x 58 x 68 mm
149-401	2,5 Watt	179 Lm	40°	3000K	● Warm white	68 x 58 x 68 mm

ACCESSORIES

ART. NR.	ACCESSORIES
149-400	Spike for garden spot 24V 149-401, 149-402 & 149-403



Garden Lights & Spots | Garden Lights

WALL LAMP | CUBE | UP & DOWN | 6W DIMMABLE

With two independently adjustable beam angles (0° to 120°).

Input voltage: 220-240V
Power: 6 Watt
Dimming method: Triac
Beam angle: 2 x 0° to 120° (independently adjustable)
IP rate: IP65
Connection type: Terminal block
Housing material: Aluminium
Housing color: Black, white or grey (RAL7016)



ART.NR.	HOUSING COLOR	POWER	LUMINOUS FLUX	COLOR TEMP. (CCT)	LIGHT COLOR	SIZE (L X W X H)
149-138	● Black	6 Watt	2 x 110 Lm	2300K	● Warm white++	100 x 100 x 101 mm
149-139	○ White	6 Watt	2 x 110 Lm	2300K	● Warm white++	100 x 100 x 101 mm
149-134	● Grey	6 Watt	2 x 110 Lm	2300K	● Warm white++	100 x 100 x 101 mm
149-144	● Black	6 Watt	2 x 110 Lm	2700K	● Warm white+	100 x 100 x 101 mm
149-145	○ White	6 Watt	2 x 110 Lm	2700K	● Warm white+	100 x 100 x 101 mm
149-133	● Grey	6 Watt	2 x 110 Lm	2700K	● Warm white+	100 x 100 x 101 mm
149-142	● Black	6 Watt	2 x 110 Lm	3000K	○ Warm white	100 x 100 x 101 mm
149-143	○ White	6 Watt	2 x 110 Lm	3000K	○ Warm white	100 x 100 x 101 mm
149-132	● Grey	6 Watt	2 x 110 Lm	3000K	○ Warm white	100 x 100 x 101 mm

WALL LAMP | CUBE | UP & DOWN | 20W DIMMABLE

With two independently adjustable beam angles (0° to 120°).

Input voltage: 220-240V
Power: 20 Watt
Dimming method: Triac
Beam angle: 2 x 0° to 120° (independently adjustable)
IP rate: IP65
Connection type: Terminal block
Housing material: Aluminium
Housing color: Black



ART.NR.	HOUSING COLOR	POWER	LUMINOUS FLUX	COLOR TEMP. (CCT)	LIGHT COLOR	SIZE (L X W X H)
149-244	● Black	20 Watt	2 x 254 Lm	2700K	● Warm white+	200 x 100 x 101 mm
149-242	● Black	20 Watt	2 x 287 Lm	3000K	○ Warm white	200 x 100 x 101 mm

Garden Lights | Garden Lights & Spots

WALL LAMP | ROUND | UP & DOWN | 6W DIMMABLE



With two independently adjustable beam angles (0° to 120°).

Input voltage: 220-240V
Power: 6 Watt
Dimming method: Triac
Beam angle: 2 x 0° to 120° (independently adjustable)
IP rate: IP65
Connection type: Terminal block
Housing material: Aluminium
Housing color: Black or white



ART.NR.	HOUSING COLOR	POWER	LUMINOUS FLUX	COLOR TEMP. (CCT)	LIGHT COLOR	SIZE (L X W X H)
149-146	● Black	6 Watt	2 x 110 Lm	3000K	○ Warm white	136 x 115 x 100 mm
149-147	○ White	6 Watt	2 x 110 Lm	3000K	○ Warm white	136 x 115 x 100 mm
149-148	● Black	6 Watt	2 x 110 Lm	2700K	● Warm white+	136 x 115 x 100 mm
149-149	○ White	6 Watt	2 x 110 Lm	2700K	● Warm white+	136 x 115 x 100 mm

WALL LAMP | DOWNLIGHT | 5,8W | 2700K DIMMABLE



Pyramid shaped downlight with a beam angle of 36°.

Input voltage: 220-240V
Power: 5,8 Watt
Dimming method: Triac
Beam angle: 36°
IP rate: IP65
Connection type: Terminal block
Housing material: Aluminium
Housing color: Black



ART.NR.	HOUSING COLOR	POWER	LUMINOUS FLUX	COLOR TEMP. (CCT)	LIGHT COLOR	SIZE (L X W X H)
149-170	● Black	5,8 Watt	640 Lm	2700K	● Warm white+	143 x 90 x 90 mm

Garden Lights & Spots | Garden Lights

WALL LIGHT | UP- & DOWNLIGHT | 5,5W 3000K NON DIMMABLE

Up- and downlight with a beam angle of 25°

Input voltage: 220-240V
Power: 5,5 Watt
Dimmable: No
Beam angle: 25°
IP rate: IP65
Connection type: Terminal block
Housing material: Aluminium
Housing color: Black



ART.NR.	HOUSING COLOR	POWER	LUMINOUS FLUX	COLOR TEMP. (CCT)	LIGHT COLOR	SIZE (L X W H)
149-160	● Black	5,5 Watt	2 x 161 Lm	3000K	○ Warm white	100 x 61 x 38 mm

WALL LIGHT | UP- & DOWNLIGHT | 2 SIZES DIMMABLE

Black or white up- and downlight, with or without light diffuser.

Input voltage: 220-240V
Power: 6,9/12,9 Watt
Dimming method: Triac
Beam angle: 90°
IP rate: IP54
Connection type: Terminal block
Housing material: Aluminium
Housing color: Black or white



ART.NR.	HOUSING COLOR	POWER	LUMINOUS FLUX	COLOR TEMP. (CCT)	LIGHT COLOR	SIZE (L X W X H)	DIFFUSER
149-150	● Black	6,9 Watt	2 x 346 Lm	2700K	○ Warm white+	115 x 90 x 28 mm	No
149-151	○ White	6,9 Watt	2 x 346 Lm	2700K	○ Warm white+	115 x 90 x 28 mm	No
149-155	● Black	12,9 Watt	2 x 508 Lm	2700K	○ Warm white+	175 x 90 x 28 mm	No
149-156	○ White	12,9 Watt	2 x 508 Lm	2700K	○ Warm white+	175 x 90 x 28 mm	No
149-157	● Black	12,9 Watt	2 x 508 Lm	2700K	○ Warm white+	175 x 90 x 28 mm	Yes
149-158	○ White	12,9 Watt	2 x 508 Lm	2700K	○ Warm white+	175 x 90 x 28 mm	Yes





Tronix Wall Light Up- & Down (Art.nr. 149-160) at villa 'the Jing | Luxury stay', Tejakula - Bali

Garden Lights & Spots | Garden Lights

GARDEN LIGHT FIXTURE | 3000K

Combine the fixture (head-part) with a 20, 50 or 80 cm high aluminium lamp Post.



Input voltage: 220-240V
Power: 15 Watt
Dimming method: Triac
LED type: Cree CXA1512
Beam angle: 360°
IP rate: IP65
Diameter: Ø115 mm
Cable length: 150 cm (3x0,75)
Connection type: 2-PG9 connector
Material: Aluminium/PC



ART.NR.	POWER	LUMINOUS FLUX	COLOR TEMP. (CCT)	LIGHT COLOR	DIMMABLE
149-330	15 Watt	1425 Lm	3000K	○ Warm white	Yes (Triac)

LAMP POST

ART.NR.	HEIGHT
149-331	20 cm
149-332	50 cm
149-333	80 cm



*Including floor mounting ring and screws (inbus)



Art.nr. 149-331 with 149-330



Art.nr. 149-332 with 149-330



Art.nr. 149-333 with 149-330



Tronix Garden Light Fixture Art.nr. 149-333 with Art.nr. 149-330 at garden residence



Front door lighting - Art.nr. 136-255

Garden Lights | Garden Lights & Spots

WALL LIGHT | 7W | IP65 | 2-CCT

With CCT switch for pre-settable color temperature 2700K - 3000K



Input voltage: 220-240V
Power: 7 Watt
Dimmable: No
Beam angle: 120°
IP rate: IP65
IK rate: IK08
Connection type: Terminal block
Material: PC/Aluminium



ART.NR.	POWER	LUMINOUS FLUX	LIGHT COLOR	SIZE (L X W X H)	DIMMABLE	MOTION SENSOR
136-240	7 Watt	700 Lm	2-CCT	251 x 167 x 80 mm	No	No
136-241	7 Watt	700 Lm	2-CCT	251 x 167 x 80 mm	No	Yes

WALL LIGHT | 3/6W | IP65 | 2-CCT

With CCT switch for pre-settable color temperature 2700K - 3000K



Input voltage: 220-240V
Power: 3/6 Watt
Dimmable: No
Beam angle: 120°
IP rate: IP65
IK rate: IK06
Connection type: Terminal block
Material: PC



ART.NR.	POWER	LUMINOUS FLUX	LIGHT COLOR	SIZE	DIMMABLE	MOTION SENSOR
136-250	3 Watt	200 Lm	2-CCT	Ø 125 mm	No	No
136-255	6 Watt	400 Lm	2-CCT	Ø 160 mm	No	No

Register

136-002.....	39	136-177.....	21	136-441.....	15	146-325.....	103
136-003.....	39	136-178.....	21	136-442.....	15	146-327.....	103
136-006.....	39	136-179.....	21	136-443.....	15	146-329.....	103
136-040.....	38	136-190.....	21	136-444.....	15	146-330.....	103
136-041.....	38	136-191.....	21	136-445.....	15	146-331.....	103
136-042.....	38	136-195.....	18	136-446.....	15	146-334.....	103
136-043.....	38	136-196.....	18	136-447.....	15	146-335.....	103
136-044.....	38	136-197.....	18	136-448.....	15	146-337.....	103
136-045.....	38	136-198.....	18	136-450.....	14	146-340.....	103
136-046.....	38	136-221.....	39	136-451.....	14	146-341.....	103
136-096.....	44	136-222.....	39	136-452.....	14	146-344.....	103
136-097.....	44	136-240.....	125	136-453.....	14	146-345.....	103
136-098.....	44	136-241.....	125	136-454.....	14	146-346.....	103
136-099.....	44	136-250.....	125	136-455.....	14	146-347.....	103
136-101.....	21	136-255.....	125	136-456.....	14	146-350.....	103
136-102.....	21	136-300.....	41	136-457.....	14	146-352.....	103
136-103.....	21	136-301.....	41	136-458.....	14	146-355.....	103
136-104.....	21	136-305.....	41	140-012.....	113	146-356.....	103
136-105.....	21	136-310.....	41	140-013.....	113	146-357.....	103
136-106.....	21	136-311.....	41	140-014.....	113	146-360.....	103
136-107.....	21	136-330.....	23	140-015.....	113	146-361.....	103
136-108.....	21	136-331.....	23	140-016.....	113	148-026.....	65
136-112.....	19	136-332.....	23	140-017.....	113	148-027.....	65
136-115.....	19	136-333.....	23	140-040.....	114	148-028.....	65
136-118.....	19	136-334.....	23	140-074.....	115	148-030.....	65
136-121.....	19	136-335.....	23	140-075.....	115	148-031.....	65
136-122.....	22	136-336.....	23	140-081.....	112	148-032.....	65
136-124.....	22	136-337.....	23	140-082.....	112	148-033.....	65
136-125.....	22	136-350.....	17	140-085.....	112	148-034.....	65
136-126.....	22	136-351.....	17	140-086.....	112	148-035.....	65
136-129.....	22	136-352.....	17	140-089.....	112	148-036.....	65
136-130.....	22	136-353.....	17	140-090.....	112	148-037.....	65
136-131.....	13	136-354.....	17	140-093.....	112	148-038.....	65
136-132.....	13	136-355.....	17	140-094.....	112	148-043.....	60
136-133.....	13	136-356.....	17	142-007.....	114	148-044.....	60
136-134.....	13	136-357.....	17	142-011.....	114	148-045.....	60
136-135.....	12	136-360.....	16	142-020.....	114	148-046.....	60
136-136.....	12	136-361.....	16	142-021.....	114	148-050.....	60
136-137.....	12	136-362.....	16	146-320.....	103	148-051.....	60
136-138.....	12	136-363.....	16	146-321.....	103	148-052.....	60
136-176.....	21	136-440.....	15	146-322.....	103	148-053.....	60



Register

148-060.....	60	149-143.....	118	169-005.....	56	169-101.....	56
148-061.....	60	149-144.....	118	169-006.....	56	169-102.....	56
148-062.....	60	149-145.....	118	169-007.....	56	169-103.....	56
148-063.....	60	149-146.....	119	169-008.....	56	169-104.....	56
148-507.....	64	149-147.....	119	169-009.....	56	169-105.....	56
148-550.....	64	149-148.....	119	169-010.....	56	169-106.....	56
148-551.....	64	149-149.....	119	169-011.....	56	169-107.....	57
148-552.....	64	149-150.....	120	169-014.....	57	169-108.....	57
148-553.....	64	149-151.....	120	169-016.....	56	169-109.....	57
148-555.....	64	149-155.....	120	169-017.....	56	169-112.....	57
148-556.....	64	149-156.....	120	169-020.....	56	169-113.....	57
148-557.....	64	149-157.....	120	169-021.....	57	169-118.....	57
148-558.....	64	149-158.....	120	169-022.....	57	169-119.....	57
148-559.....	64	149-160.....	120	169-023.....	56	169-120.....	57
148-560.....	64	149-170.....	119	169-024.....	56	169-150.....	55
148-563.....	64	149-242.....	118	169-025.....	56	169-151.....	55
148-565.....	64	149-244.....	118	169-026.....	56	169-152.....	55
148-569.....	64	149-330.....	122	169-027.....	56	169-153.....	55
148-570.....	64	149-331.....	122	169-028.....	56	169-274.....	53
148-571.....	64	149-332.....	122	169-029.....	56	169-275.....	53
148-572.....	64	149-333.....	122	169-030.....	56	169-276.....	53
148-573.....	64	149-350.....	116	169-031.....	56	169-279.....	53
148-574.....	64	149-351.....	116	169-032.....	56	169-292.....	53
148-575.....	64	149-352.....	116	169-035.....	56	169-293.....	53
148-576.....	64	149-355.....	116	169-036.....	57	169-296.....	53
148-577.....	64	149-356.....	116	169-037.....	56	169-297.....	53
148-578.....	64	149-358.....	116	169-038.....	57	169-299.....	53
148-579.....	64	149-400.....	117	169-039.....	57	169-307.....	54
148-580.....	64	149-401.....	117	169-040.....	56	169-308.....	54
148-581.....	64	149-402.....	117	169-041.....	56	169-310.....	54
148-582.....	64	149-403.....	117	169-042.....	56	169-311.....	54
148-583.....	64	165-000.....	72	169-043.....	56	169-313.....	54
148-584.....	64	165-031.....	72	169-044.....	56	169-314.....	54
148-585.....	64	165-032.....	72	169-045.....	56	169-362.....	53
148-586.....	64	165-033.....	72	169-046.....	56	169-363.....	53
149-132.....	118	165-034.....	72	169-047.....	56	173-001.....	28
149-133.....	118	165-035.....	72	169-048.....	56	173-002.....	28
149-134.....	118	165-036.....	72	169-049.....	56	173-005.....	26
149-138.....	118	165-038.....	72	169-072.....	56	173-006.....	26
149-139.....	118	169-002.....	57	169-073.....	57	173-015.....	26
149-142.....	118	169-003.....	57	169-074.....	56	173-016.....	26

Register

173-021.....	28	175-343.....	55	220-052.....	109	600-036.....	84
173-022.....	28	175-344.....	55	220-055.....	109	600-037.....	84
173-025.....	27	175-347.....	55	220-062.....	109	600-038.....	84
173-026.....	27	175-350.....	55	220-080.....	109	600-039.....	81
173-035.....	27	175-369.....	53	220-081.....	109	600-040.....	81
173-036.....	27	175-370.....	70	595-021.....	35	600-041.....	81
173-048.....	29	175-372.....	70	595-022.....	35	600-042.....	81
173-050.....	26	175-536.....	108	595-030.....	35	600-043.....	78
173-051.....	27	175-537.....	108	595-033.....	35	600-100.....	87
173-052.....	26	175-538.....	108	595-034.....	35	600-101.....	87
173-053.....	27	175-539.....	108	595-035.....	35	600-102.....	87
173-095.....	35	175-550.....	68	595-036.....	35	600-103.....	87
173-096.....	35	175-555.....	68	595-037.....	35	600-104.....	87
173-100.....	34	175-570.....	68	595-038.....	35	950-024.....	93
173-101.....	34	175-575.....	68	595-039.....	35	950-078.....	98
173-103.....	34	179-002.....	43	595-040.....	35	950-079.....	98
173-110.....	34	179-004.....	43	595-042.....	35	950-086.....	96
174-029.....	33	179-022.....	43	600-018.....	79	950-087.....	96
174-105.....	34	179-024.....	43	600-019.....	80	950-088.....	96
174-106.....	34	179-050.....	43	600-020.....	80	950-095.....	98
174-107.....	34	179-060.....	43	600-021.....	78	950-105.....	90
174-237.....	33	179-061.....	43	600-022.....	79	950-106.....	90
174-270.....	31	179-080.....	43	600-023.....	82	950-110.....	90
174-271.....	31	179-081.....	43	600-024.....	82	950-111.....	90
174-275.....	31	179-082.....	43	600-025.....	82	950-112.....	90
174-276.....	31	214-051.....	35	600-026.....	82	950-113.....	90
175-137.....	55	214-166.....	29	600-027.....	83	950-114.....	90
175-138.....	69	214-178.....	29	600-028.....	34	950-115.....	90
175-142.....	55	220-040.....	108	600-029.....	83	950-116.....	90
175-143.....	55	220-041.....	106	600-030.....	79	950-120.....	93
175-144.....	55	220-042.....	106	600-031.....	79	950-121.....	93
175-154.....	69	220-045.....	106	600-032.....	79	950-122.....	93
175-316.....	71	220-046.....	106	600-033.....	57		
175-323.....	71	220-050.....	109	600-034.....	57		
175-324.....	71	220-051.....	109	600-035.....	84		





CARE



SHARE



CONNECT



Tronix / Vluchtoord 41, 5406 XP Uden / Postbus 205, 5400 AE Uden / The Netherlands
+31 (0)413 330 380 / sales@tronixlighting.com / www.tronixlighting.com

